

# THE WAYNE HERALD

Second Class Postage Paid at Wayne Nebraska

WAYNE, NEBRASKA 68787, THURSDAY, JUNE 14, 1979  
ONE HUNDRED THIRTY YEAR NUMBER EIGHTY-FIVE

Published Every Monday and Thursday at  
114 Main, Wayne, Nebraska 68787



## Citizenship Award

JEFF ZEISS (right) holds a trophy he was presented for citizenship at the annual Boys' State encampment held last week. Zeiss was one of ten to be honored with the award. He was selected by other Boys' Staters in the town of Gettysburg. Zeiss was also elected a State Senator to represent his area. Brad Emry, who attended Boys' State last year, was elected a Junior Counselor at this year's encampment. He was picked as 1 of 11 counselors out of some 400 boys from throughout the state. With Jeff is Jean Nuss, commander of the Irwin Sears American Legion post which sponsored Zeiss at Boys' State.

## Under Seven Percent Lid

# Board Looks at Preliminary Budget

The Wayne-Carroll school district may be able to live with the seven percent lid, according to a preliminary budget presented Monday night at the regular meeting of the school board.

Supt. Dr. Francis Haun explained the proposed budget shows a 5.94 percent increase but that the effective increase would come somewhere in the neighborhood of 6.2 percent.

The proposed 1979-80 school budget amounts to \$1,684,768 as compared with 1,479,358 for the 1978-79 school year. The new budget includes a new program for pre-school children in special education.

Supt. Haun said \$4,875 in budgeted for the program as there are two known students in the pre-school section of special education. He pointed out the figure allows for one more student if the need arises.

The budget is geared for the seven percent lid imposed by the legislature except for new provisions this year which allows for exemptions for the pre-school program, fuel, electricity and social security.

Supt. Haun said the main items of concern will be plant operation and fuel which are blowing the top off of the budget.

The summary of the proposed budget, which will not be adopted until the August meeting, shows (figure in parenthesis, 1978-79 figure):

(Instruction, \$915,610 (\$862,173); Special Education, \$90,641 (\$86,398); Driver Education, \$4,635 (\$4,000); Vocational Education (TV) \$14,321 (\$13,066); (BI) \$9,149 (\$8,261); Guidance, \$21,208 (\$19,762); Health, \$11,414 (\$8,803); Pupil Support, \$36,746 (\$33,379); Staff and Curriculum, \$3,550 (\$3,450); Library and Audio-Visual, \$51,952 (\$55,961); Board of Education, \$7,615 (\$7,385); Administration, \$41,671 (\$39,059).

Principals, Office and Supplies, \$96,468 (\$86,282); Business Support, \$31,030 (\$28,335); Vehicle, Ag. and Maintenance, \$735 (\$725); Operation of Plant, \$145,085 (\$130,742); Maintenance, \$31,350 (\$32,400); Pupil Transportation, \$60,254 (\$51,341); Special Education Transportation, \$1,700 (\$1,700); Summer School, \$5,929 (\$5,096); Ad. Ed. \$1,000 (\$500); Supt. Haun explained the lid calculation for the budget is based on anticipated

receipts. They are: Homestead, \$21,495; Pro Data Motor Vehicle, \$4,500; State Aid, \$70,000; Apportionment, \$20,000; Special Education (General), \$30,000; Driver Education, \$3,600; Lunch, \$4,000; Vocational Education, \$3,400; Ins. Prem. Tax, \$19,000; HS Tuition, \$240,700; Special Education Tuition, \$16,000; Local Taxes, \$908,425 for a grand total of \$1,391,120. A seven percent increase would amount to \$97,378.



REX FISHER, general manager of the Farmers Co-op Elevator, looks over the smoldering remains of a fertilizer blending plant which was destroyed by fire Saturday night in Allen. A leg tower was toppled by the heat from the fire.

## Saturday Night Fire Destroys Allen Fertilizer Plant

A fire Saturday evening destroyed the Allen Farmers Co-operative fertilizer plant with the estimated damage being placed between \$150,000 and \$200,000 by Rex Fisher, general manager.

Fisher said that if the wind had been from the east, it would have destroyed the elevator as well.

approximately 200 tons of fertilizer in the plant at the time of the fire.

Fisher said the alarm was turned in at 11:15 p.m. by Kevin Hill who noticed the smoke. According to Allen Fire Chief Jerry Schroeder, the fire had a good start by the time the department arrived on the scene.

The fire destroyed the blending plant and toppled two 100 foot legs. There was rolled up their hoses about 3 a.m.

The original plant was built in 1962 and has been remodeled since then, according to Fisher. Fisher said the cooperative was formed in 1915.

## Board Approves Window Project

The Wayne-Carroll board of education Monday night voted to tackle all of the windows that need replacing in the Wayne Middle School, rather than just half as first proposed.

Marra Home Improvement company, Wayne, was the low bidder on the initial 92 windows outlined in the initial bid. The bid was \$33,400.

Dennis C. Hirschbrunner, professional engineer for Bruce Gilmore and Associates, Columbus, presented the new rates after reviewing the current rates.

The windows will be bronze, providing insulating panel and thermal insulating glass. Moore said this type of windows is cheaper and faster to obtain. He estimated a ten week delivery date.

Moore also told the board his organization would carry a bank interest note for one year to do the entire project of 191 windows.

Supt. Dr. Francis Haun told the board the school could pay about \$48,000 this year. The total cost of the window replacement is estimated at \$69,000.

The window replacement is designed to add fuel efficiency to the building.

Connections outside the City of Wayne: A minimum of \$12 for six months. Up to 8,000 gallons, \$1.50 per 1,000 gallons, next 16,000 gallons, 90 cents per 1,000 gallons, over 40,000 gallons, 75 cents per 1,000 gallons.

He also said the new rates are based on a break even margin and that a yearly review will have to be made to keep up with inflation and operating expenses.

## Puffer Around And Win Prizes

Drive for show. Puff for dough. That's the name of the game.

The Wayne Chamber of Commerce is sponsoring a "Puff It In for Dad" contest Saturday from 10 a.m. to 2 p.m. on the sidewalk at 213 Main (in front of the former Gamble's store).

For those who get the ball in the hole there will be gift and discount certificates, while they last, from participating Chamber merchants.

## City Chips In For Fireworks

Area youngsters will once again see a brilliant fireworks display by the Wayne Jaycees July 5.

Ben Stockdale, president of the Wayne Jaycees, appeared before the city council Tuesday night and requested the city donate \$250 to the cost of the display which ran over a \$1,000 last year.

The council agreed to the proposal. Stockdale also said the Jaycees will consider "ram-rodding" the renovation of the Wayne ballpark. The question will be brought before the members during the July meeting.

## Carroll Saddle Club Show Draws Riders from 29 Towns

The 16th annual Carroll Saddle Club Horse Show and Saddle Club rodeo was held Sunday, June 10 at the arena in Howells Saddle Club received two trophies for the best appearing and having the most horses.

A large trophy, given by Mr. and Mrs. Don Frink in memory of their son, Brian, was won by Dave Asmus of Hoskins who was winner of the Senior Polo Division. Trophies, ribbons and payback jack pot was presented to winners.

There were 14 races for children, twelve years and under. Bobbi Dittick, Meadow Grove; Gene Daniel, Stanton; Jan Hansen, Stanton and Kelli Davis, Carroll.

## Playground Equipment Plan Gets 'Go-Ahead' by Board

A move to provide school playgrounds with equipment that not only is fun to play on but is designed to build perceptual motor skills, was given board approval Monday night at the regular meeting of the Wayne-Carroll board of education.

Luff said the present equipment is old and "dangerous," pointing out mishaps on swings, slides and merry-go-rounds.

The board authorized Don Koeng, Wayne wrestling coach, to develop a preliminary master plan for the elementary and middle schools and present it to the board at a special session set for 7 p.m. on Monday, June 18.

Luff and other interested parties toured schools in Omaha and came back with pictures to show to the board. The equipment used in the Omaha schools was made of redwood treated lumber, specially treated tires, a swinging bridge which are designed to "search and explore."

The board will review the plan and make an on-site inspection to acquaint themselves with the space and planned location of the pieces of equipment.

Becky Kiedel, president of the Community Council, was on hand and Kay Marsh, a member of the Council, were present for the meeting.

Elementary Principal Dave Luff and Middle School Principal Richard Metteer will assist Koeng with planning.

Mrs. Kiedel congratulated the board for being "sensitive to the needs of the children" and that a creative playground for all children would "substantially enrich their curriculum for motor perception."

The men will be compensated for their efforts with Koeng serving as "foreman." Koeng suffered an injury recently when he fell 35 feet from a ladder while trimming branches from a tree.

Sid Hillier, president-elect of the Wayne Kiwanis club, said the civic organization is interested in early childhood education and said it would lend as much volunteer labor and financing as possible to the proposed project.

## Salute to Area Farm Women is June 28

Wayne businessmen are once again preparing to salute area farm women during the fifth annual Farm Ladies Appreciation Luncheon slated later this month.

Decorations for the luncheon will coincide with the theme, "Country Garden Party."

The Chamber of Commerce-sponsored event begins at 12:30 p.m. Thursday, June 28, at the Wayne State College Student Union. Gary Van Meter, executive vice president of the Chamber of Commerce, said the luncheon is held each year to stress the importance of women in the area's economy.

The program will be emceed by Mrs. Sheryl Marra, co-chairman for this year's luncheon. Glen Ellingson, president of the Chamber of Commerce, will welcome the women, followed with a response from farm wife Mrs. Dwayne Reithwisch. The invocation will be given by Mary Edmonds.

Last year's luncheon proved to be popular when some 450 farm wives and women turned out.

The organization is made of nearly 400 dealers statewide, employing some 18,000 people.

Women who have not already registered to attend this year's free luncheon and program are urged to do so before Thursday, June 21. Registration forms are available at sponsoring Wayne businesses.

See SALUTE, page 12

## News in Brief

**Scouts On Camping Trip**  
Wayne Boy Scout Troop 174 discussed two summer camping trips following a Court of Honor recently. Six boys and a leader are attending Camp Cadars south of Fremont until June 16.

On July 14, four boys from Troop 174 and three from Troop 175 along with two adult leaders from Troop 174 will leave for Phillmont Scout Ranch near Cimarron, N.M. for a two-week backpacking trip.

**Elected NE Director**  
Glen Ellingson of Ellingson Motors, Wayne, has been named district director for the 17th legislative district by the Nebraska New Car and Truck Dealers Association.

The organization is made of nearly 400 dealers statewide, employing some 18,000 people.

See NEWS BRIEFS, page 12

See PUTTER, page 12

See CARROLL, page 12

# Present Recital

"Around the World With Music" was the theme of the Friday and Saturday evening at the lecture hall at Wayne High School.

Plano selections were presented by students of Mrs. Emil Ukan of Wayne.

Performing Friday evening were Seth Anderson, Jo Carlson, Shelley Emry, Gary and Sharon Foote, Jodi Freese, Ranae Fuoss, Dawn Glessmeyer, Christy Hagerbaumer, Christy Heinemann, Kara and Mark Janke, Shannon and Shelly Janke, Vini Johar, Melissa Johnson, Karen Kaup, Bethany Keldie, Jeanne Morris, Lesa McDermott, Holly Nichols, Debi Penn, Mary Sieler, Jennifer and Julie Wessel, David and Steven Zahniser, and Amy, Heidi and Wendy Wriedt.

Duets Friday night were by Lesa McDermott and Mary Sieler, and Christy Hagerbaumer and Steven Zahniser.

Plano selections Saturday evening were presented by Keri and Kurt Boeckenhauer, Lisa Botenkamp, Deborah Bull, Valerie Bush, Brett Fuellebier, Renee Gehner, Terri and Todd Gehner, Shane Gelger, Lisa and Lori Jacobson, Darci Johnson, Leigh Johnson, Paula Koplin, Amy Oswald, Cristl and Julie Oswald, Holly and Penny Paige, Cathy Peterson, Rod Porter, Carman Reeg, Debi and Robb Reeg, Eric Runquist, Karen Sandahl, Brian and Rebecca

# Former Wayne Resident Gets \$1,000 Endowment

A former resident of Wayne has been named the Kenneth Williams Scholarship Award winner at Florida Atlantic University (FAU) in Boca Raton.

Kenneth E. Jones, son of Mr. and Mrs. Earl R. Jones of Cape Coral, Fla. formerly of Wayne, received the \$1,000 Endowment Award during commencement exercises June 9.

Jones is a nephew of Eveline Thompson and Mr. and Mrs. Herbert Perry, all of Wayne, and Mr. and Mrs. Arnold Junk of Carroll.

Jones was one of two students to receive the award, which was

established in 1972 to honor retiring FAU president Williams through a \$50,000 endowment fund. The awards are given annually to two baccalaureate candidates, one on the basis of scholarship and the other for leadership qualities.

Jones, 30, has earned a perfect 4.0 grade-point average and has been named to the President's Honors List every academic quarter since he entered the University in the fall of 1977. He is a member of Phi Kappa Phi honor society.

A major in art in FAU's College of Humanities, he has been active in art programs at the University and in the community, and his work has been exhibited frequently.

Primarily interested in sculpture, Jones has worked principally in constructed sculpture with cement and steel. One of his abstract subjects, eight feet in height, may soon be on display on the FAU campus near the sculpture studio.

Jones plans to tour the United States to exhibit his work at open air art shows and ultimately to open an art studio of his own.

A veteran of the Vietnamese War, he served in the U.S. Air Force from 1968-72 and earned his A.A. degree in 1975 from Edison Community College in Fort Myers, Fla.



KENNETH JONES



Wed in Emerson

ST. PAUL'S Lutheran Church of Emerson was the scene of the May 28 wedding ceremony uniting in marriage Cynthia Reitz and Randall Bargholtz. Parents of the couple are Mr. and Mrs. Harvey Reitz of Emerson and Mr. and Mrs. Elmer Bargholtz of Wakefield. The bride is a 1975 graduate of Emerson-Hubbard High School and a 1976 graduate of Northeast Technical Community College, Norfolk. The bridegroom was graduated from Wakefield High School in 1974. They are making their home at 418 E. Ninth St., Wayne.

# You Are Invited To A Garden Party

When: Saturday, June 16th  
Afternoon 2 to 4 p.m., or evening 7 to 9 p.m.

Where: You Marshall Nannies Representative:  
Gal Korn  
3 miles South on Hwy 15, West Side

Refreshments will be served  
Rsvp Date is Saturday, June 23

# Mackeys Observe Silver Year

The silver wedding anniversary of Mr. and Mrs. Jerome Mackey of Laurel was observed June 3 at the Laurel city auditorium.

Friends and relatives attended the open house reception from Sioux City and Council Bluffs, Ia.; Sycamore, Ill.; Dearborn, Mich.; Gretna, Omaha, Bancroft, West Point, Laurel, Dixon, Allen, Concord, Leshara, Wakefield, Crofton, Waterbury, Wayne, Lincoln, O'Neill, Orchard, Ponca and Newcastle.

The event was hosted by the couple's children, Larry Mackey of Hickley, Mr. and Mrs. Marvin (Marilyn) Steffen, Brian and Chris of Crofton, Mr. and Mrs. Brad (Denice) Jones of Norfolk, and Karen and Colleen Mackey, both at home.

Colleen Mackey was mistress of ceremonies for the afternoon program. Opening and closing devotions and the table grace were given by the Rev. Frederick Cook.

Larry Mackey, Donice Jones and Marilyn Steffen gave a reading of their parents' courtship and marriage. Colleen Mackey presented a flute solo, accompanied by Karen Mackey, and the children of the couple sang "Here's to Mom and Dad."

The cake, which was baked by Mrs. Jim Urwiler of Laurel, was cut and served by Vera Ebmeier and Mrs. Howard Delterson of Laurel. The mints were made by Mrs. Westergaard Knudsen of Laurel.

Mrs. Gene Mackey of Gretna and Mrs. Vonnie Tangeman of Council Bluffs, and Mrs. Harold Wegner of West Point served punch. Women who assisted at the dining table were Mrs. Morris Ebmeier and Mrs. Paul Ebmeier, both of Laurel.

Women assisting in the kitchen were Mrs. Arnold Ebmeier, Mrs. Allan Brodeur, Mrs. Glimmer Stark, Mrs. Armin Stark, Mrs. Jack Erwin, Mrs.

Dean Pippitt and Mrs. Delwyn Daberku, all of Laurel.

Waitresses were Mary Ebmeier of Fremont, Mrs. Steven Ebmeier of Laurel and Lori Wegner of West Point.

Seated at the head table with the honored couple were their children and grandchildren. Mackey's mother, Mrs. Effie Mackey of Bancroft, his great aunt, Emma Haisch of Wayne

# Mrs. Wischhof Club Hostess

Members of the Logan Home makers Club answered roll call last Thursday by naming a favorite food made at home by their mother.

Ten members attended the meeting in the home of Mrs. Laverne Wischhof. Guests were Mrs. Irene Geewe and Mrs. Duane Jacobsen and daughter.

The meeting opened with the singing of "America." Mrs. Ronald Perterick presided. The group made tray favors for Providence Medical Center.

The club is planning a family picnic on June 24 at 6:30 p.m. at Bressler Park in Wayne. Next regular meeting will be Sept. 6 at 2 p.m. at Bressler Park for guest day.

# Class of '49 Meeting

The 1949 graduating class of Wayne High School is planning a 30-year reunion on Aug. 11 at the Black Knight in Wayne.

Classmates are urged to have their reservations for the banquet in by June 30 to Mrs. Dale Lessmann of Wayne. Friends of the class are welcome to stop at the Black Knight to visit with the classmates. Social hour will begin at 6:30.

# LWML Meets at Altona

First Trinity Lutheran Women's Missionary League of Altona met June 6 with 13 members and two guests, Mrs. Harris Pflueger and Mrs. Allen Shuffelt.

The group sang two hymns, accompanied by Mrs. Robert Greenwald. Prayer was given by Mrs. Kenneth Frevert, and the lesson, entitled "Christ for Us," was led by Mrs. Harris Heinemann. The scripture was an independent study by each member of the group on the book of Hebrews.

The business meeting was conducted by the president, Mrs. Delvin Mikkelson. Reports were given by secretary Mrs. Ernest Steffen and treasurer Mrs. Paul Hilpert.

A birthday card, signed by each member of the group, was sent to the Rev. Carl F. Broecker of Amery, Wis., a former pastor of the First Trinity Lutheran Church. Members voted to sponsor a

Lutheran radio broadcast over Wayne radio KTCB.

The birthdays of Mrs. Paul Hilpert, Mrs. Melvin Stultman and Mrs. Walter Wesemann were honored with song.

Hostesses were Mrs. Leon Meyer and Mrs. Delvin Mikkelson.

# Son Baptized

A baptism rite was held at St. Paul's Lutheran Church in Winslow Sunday morning for Anthony William Hansen, son of Mr. and Mrs. Dan Hansen of Carroll.

Sponsors were Mr. and Mrs. Dave Rahberg of Grand Island. Dinner guests afterward in the Hansen home included Mr. and Mrs. Dave Rahberg of Grand Island, Mr. and Mrs. William Lohmeyer of Washington, Mo., Mr. and Mrs. Cyril Hansen and family and Mr. and Mrs. Ron Sebade and family, all of Wayne, and Mr. and Mrs. Kelly Hansen of Hope, Ia.

Anthony received an emergency baptism at the Lutheran Hospital in Norfolk following his birth.

# Concordia Lutheran Lawn Site Of Anderson-Treptow Wedding

Glenns Anderson, daughter of Mr. and Mrs. Norman Anderson of Concord, and Douglas Treptow, son of Dr. and Mrs. Kenneth Treptow of Aurora, exchanged wedding vows in a 7 p.m. ceremony June 1 on the lawn of the Concordia Lutheran Church, Concord.

Honor attendants for the couple were the bride's sister, Alvina Stanson at Dixon, and the bridegroom's brother, Warren Treptow of Salt Lake City, Utah.

The Rev. David Newman of Concord officiated at the double ring ceremony. Pianist was Craig Treptow of Aurora. Kevin Blecke of Wayne sang "For Baby" and "The Lord's Prayer," accompanied by Tracy Otte, also of Wayne.

Ushers were Dan Scarborough of Grand Island and Bill Tannehill of Wisner.

Given in marriage by her father, the bride appeared in a white floor length gown of sheer organza over taffeta. The sleeveless off the shoulder neckline was trimmed with a sheer ruffled edge with satin ribbon and wide gathered lace. Ruffle trimmed in lace also edged the hemline of the A line fashion. She wore a cluster of flowers in her hair and carried a bouquet of silk yellow roses and daisies.

The matron of honor wore a yellow knit in floor length designed with a gathered yoke, short raglan sleeves, and slash opening fastened with self ties and a self fabric belt at the waistline. She wore a small cluster of flowers in her hair and carried a nosegay of silk yellow and white daisies.

The bridegroom was attired in a white tuxedo trimmed in black with a white shirt edged in yellow. The best man wore a yellow tuxedo and white shirt edged in yellow.

Mrs. Anderson wore a light pink chiffon knit for her daughter's wedding, and Mrs. Treptow selected a floral beige knit. Both wore an orchid corsage.

Nearly 160 guests, registered by Barb Gethman of Grand Island, attended a reception afterward at the church. Gifts were arranged by Mr. and Mrs. Ralph Etter of Wayne.

Hosts were Mr. and Mrs. Albert Sieck of Chicago.

The wedding cake was cut and served by Mrs. Fern Erickson of

Wayne and Mrs. Pat Poppe of Cook. Serving the bridegroom's cake were Mrs. Arlyce Carlson of Concord and Mrs. Carolyn Fisher of Wahoo.

Mrs. Mary Hasek of Wahoo poured, Jill Hanson of Allen, Mary Arnold of Grand Island, Denise Magnuson of Creighton and Janis Wallin of Kearney served punch.

Waitresses were Jeanie Lindquist of Wahoo, Debbie Barry of

Weston and Kim Blecke and Tracy Otte, both of Wayne.

The newlyweds are making their home in Omaha. The bride was graduated from Laurel High School in 1974 and Kearney State College in 1979. The bridegroom, a 1975 graduate of Aurora Public School and a 1979 graduate of Kearney State, is a student at the University of Nebraska Omaha School of Medicine.



MR. AND MRS. DOUGLAS TREPTOW

# Invited to Museum

Persons interested in the history of Wayne County are invited to visit the historical museum in Wayne this Sunday afternoon from 2 to 4.

Hosts at the museum, which is located at Seventh and Lincoln Streets will be Mr. and Mrs. Bob Garhart and Leola Moller.

# Come to Church

- ASSEMBLY OF GOD CHURCH (A.R. Weiss, pastor) Sunday: Sunday school, 9:45 a.m.; worship, 10:45 a.m.; evening service, 7:30 p.m.
- FIRST CHURCH OF CHRIST (MARK WEBER, pastor) Sunday: Bible study, 9:30 a.m.; worship and communion, 10:30 a.m.; Holy Communion, 7:30 p.m. Wednesday: Bible study, 8 p.m.
- FIRST TRINITY LUTHERAN CHURCH (Allona Missouri Synod) (Willard Kaskula, vacancy pastor) Sunday: Worship, 8:30 a.m.; Sunday school, 9:30 a.m.; Vacation Bible school, 9 a.m. to 12 p.m.
- FIRST UNITED METHODIST CHURCH (Kenneth Edmonds, pastor) Sunday: Worship, 9:30 a.m.; Holy Communion, 10:30 a.m.; Monday: United Methodist Men work night, 7 p.m.; Wednesday: Men's prayer break, 9:30 a.m.; Quilters, interest group, 7:30 p.m.; prayer group, 7:30 a.m.; Trustees, 8 p.m.
- GRACE LUTHERAN CHURCH (Thomas Mendenhall, pastor) Sunday: Sunday school, 9:45 a.m.; Monday: Board of Stewardship, 7:30 p.m.; Tuesday: Sunday school staff, 7:30 p.m.
- IMMANUEL LUTHERAN CHURCH (Ronald Melling, vacancy pastor) Sunday: Worship, 8:30 a.m.; Sunday school, 9:30 a.m.
- INDEPENDENT FAITH BAPTIST (Bernard Maxson, pastor) Sunday: Sunday school, 10 a.m.; worship, 11:00 a.m.; evening worship, 7:30 p.m. Wednesday: Bible study, 7:30 p.m. For free bus transportation call 375-3431 or 375-2358.
- Jehovah's Witnesses 2nd and Pearl Sts. Sunday: Public talk, 9:30 a.m.; watchtower study, 10:20 a.m.; Wayne Women's Club, 7:30 p.m.; service meeting, 8:30 a.m.; Wayne Woman's Club room. For more information call 375-4155.
- REDEEMER LUTHERAN CHURCH (Ronald Melling, vacancy pastor) Sunday: Worship, 9:30 a.m.; Sunday school, 10:30 a.m.; Tuesday: Bible study, 9:15 a.m.; Wednesday: Ministerial meeting, 9:30 a.m.; visitation, 1:30 p.m.
- ST. ANSELM'S EPISCOPAL CHURCH (James M. Bissett, pastor) Sunday: Morning prayer, 10:30 a.m.
- ST. MARY'S CATHOLIC CHURCH (Thomas E. McDermott, pastor) Thursday: Mass, 9 a.m.
- Friday: Mass, 9 a.m.; Saturday: Mass, 8 a.m. and 10 a.m.; Monday: Mass, 9 a.m.; St. Mary's Parish School, 7:30 to 9 p.m.; Tuesday: Mass, 9 a.m.; Wednesday: Mass, 9 a.m.
- ST. PAUL'S LUTHERAN CHURCH (Daniver Peterson, pastor) Thursday: Alcohol counseling, 9 a.m.; LCW sewing day, 9:30 a.m.; Sunday: Sunday school, 9:15 a.m.; Luther League, 9:15 a.m.; worship, 10:30 a.m.
- THEOPHILUS CHURCH (Gary Karles, Robert Rich, Dr. Steven Dismore, lay ministers) Sunday: Worship, 9:30 a.m.
- WAKEFIELD CHRISTIAN CHURCH (Greg Hater, pastor) For bus service to Wakefield church services call Lee Swinney, 375-1566.
- WESLEYAN CHURCH (Bernie Cowgill, pastor) Sunday: Sunday school, 9:45 a.m.; worship, 11 Bible study, 7 p.m.; evening worship, 7:30 p.m.; Wednesday: Prayer meeting and Bible study, 7:30 p.m.; CYC, 7:30 p.m.

Make a Trip to the HOTTEST TOWN! GAY THEATRE PH. 375-1280

NOW THRU TUESDAY At 7:30 p.m. Except Fri. Sat. 7:00 & 11 p.m. Matinee 2 p.m. Saturday

WALT DISNEY

THE NORTH AVENUE IRREGULARS

4 Days! June 23 Winner 79 Canses Best Actress

Norma Rae

3 Days! June 24-26 Best Picture Nominee she makes love she scares his

unmarried woman

DUDE RANCH DRIVE-IN THEATRE

NOW THRU TUESDAY! JOHN & OLIVIA ARE BACK! GREASE

# THE WAYNE HERALD

Serving Northeast Nebraska's Great Farming Area

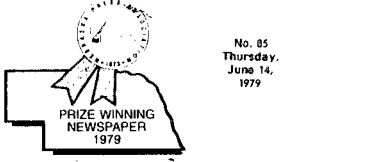

114 Main Street Wayne, Nebraska 68787 Phone 375-2400

Established in 1875; a newspaper published semi-weekly, Monday and Thursday (except holidays), by Wayne Herald Publishing Company, Inc., J. Alan Cramer, President; entered in the post office at Wayne, Nebraska 68787. 2nd class postage paid at Wayne, Nebraska 68787.

NATIONAL NEWSPAPER PUBLICATION

1979-1980

NNA SUSTAINING MEMBER - 1975

Chuck Barnes Editor

Jim Marsh Business Manager

Official Newspaper of the City of Wayne, the County of Wayne and the State of Nebraska

PUBLICATION NUMBER - USPS 670-540

SUBSCRIPTION RATES

In Wayne, Pierce, Cedar, Dixon, Thurston, Cuming, Stanton and Madison Counties: \$9.79 per year, \$7.58 for six months, \$5.86 for three months. Outside counties mentioned: \$11.25 per year, \$9.00 for six months, \$7.75 for three months. Single copies 15 cents.

# FABRIC SPECIAL

300 YDS. SALE

Special group of spring and summer fabrics. Buy one yard at sale price - select a second yard for 1'.

ENTIRE STOCK SUMMER FABRIC

McDonald's 20% OFF Marked Price

READ AND USE WAYNE HERALD WANT ADS

# Presbyterian Church Site Of Tooker-Lindner Rites

A spiral candelabra, greenery and yellow and peach tinted daisies decorated the United Presbyterian Church in Wayne for the June 8 wedding ceremony of Laura Tooker and Paul Lindner.

## Laverle Miller Is Accepted

Laverle Lee Miller, son of Mr. and Mrs. Vernon Miller of Hoskins, has been accepted for admission to Westmar College in LeMars, Ia.

Miller was graduated from Winside High School.

Westmar is a fully accredited, four-year, liberal arts college in northwest Iowa. The 82-acre campus is home to students from 23 states and several foreign countries.



LAVERLE MILLER

The bride is the daughter of Mr. and Mrs. Earl Tooker and the bridegroom is the son of Mr. and Mrs. Herman Lindner, all of Wayne.

Tammie Schulz of Wayne registered the guests, who were ushered into the church by Daryl Wittstruck of Martell, Terry Miller of Norfolk and Roger Niemann of Wayne.

Candlelighters were Andrea Tooker and Susan Lindner, both of Wayne.

The Rev. Robert Haas officiated at the 7:30 p.m. double ring ceremony. Wedding music included "Feelings," "With These Hands," "Evergreen" and "Follow Me." Soloist was Mrs. Cheryl Kopperud. Organist was Mrs. Jana Rutledge and flutist was Kathy Haas. All are of Wayne.

For her wedding day the bride wore an ivory gown of satin and sheer organza in floor length designed with a high waistline and shaped hemline train. Venice lace and beading accented the high neckline with a sheer yoke and fitted sleeves. Her silk illusion veil was edged with ivory lace and attached to a lace-trimmed headpiece. The gown and veil were designed by the bride's mother.

The bride carried a cascade of Robin Aby roses accented with ivory and white Stephanotis.

Her attendants were Lisa Tooker, Robyn Bornhorf and Cindy Lindner, all of Wayne. Their peach-colored floor-length dresses were designed with draped necklines and pleated skirts. They carried Robin Aby roses.

The bride's personal attendant was Teresa Clifton of Scottsbluff.

Harry Lindner of Norfolk served as best man. Groomsmen were St. Praetrix and Bret Spolice, both of Wayne. The bridegroom wore an ivory tuxedo with brown trousers.

Mrs. Tooker wore a green street-length dress for her daughter's wedding, and Mrs. Lindner wore a pink floor-length dress. Both wore a rose and daisy corsage.

A reception for 150 guests at the church and a dance at the Wayne Vets Club followed the wedding ceremony. Hosts were Mr. and Mrs. Miron Jenness of Wayne. Gifts were arranged by Beverly and Kathy Walton of Creighton.

The wedding cake was cut and served by Mrs. Glenda Walton of Creighton and Mrs. JoAnn Clifton of Scottsbluff. Mrs. Ella Williams of Columbus and Mrs. Gerda Dorcy of Ponca poured and Julie Overin of Wayne served punch.

Waitresses were Becky Blendenman and Ann Jenness, both of Wayne.

The newlyweds took a wedding trip to the Black Hills and are residing at 601 Westwood Rd., in Wayne.

The bride was graduated from Wayne High School in 1977 and from Northeast Technical Community at Norfolk as a practical nurse in 1978. She is employed at Providence Medical Center, Wayne. The bridegroom is a 1976 Wayne High graduate and a 1978 graduate of building construction at Northeast Technical Community College. He is employed at Lindner Construction Co.

# SPEAKING OF PEOPLE

**THURSDAY, JUNE 14**  
T and C Club, Mrs. Charles Nichols, 2 p.m.  
Sunny Homemakers Club, Mrs. Carl Meth, 2 p.m.  
Roving Gardeners Club, Mrs. Walter Splitzberger, 2 p.m.

**FRIDAY, JUNE 15**  
Senior Citizens Center sermonette and singing, 2 p.m.

**MONDAY, JUNE 18**  
WWI Auxiliary, Vets Club, 2 p.m.

**TUESDAY, JUNE 19**  
LaPorte Club, Mrs. Albert Sundell, 2 p.m.  
Villa Wayne Tenants Club meeting, 2 p.m.

**WEDNESDAY, JUNE 20**  
Villa Wayne Bible Study, 10 a.m.  
Senior Citizens Center monthly potluck luncheon, noon  
Just Us Gals Club, Mrs. Clara Spahr, 2 p.m.  
Club 15, Mrs. Bob Foote, 2 p.m.  
Pleasant Valley Club, Mrs. Don Pedersen, 2 p.m.  
Tops Club, West Elementary School, 2 p.m.

**THURSDAY, JUNE 21**  
Immanuel Lutheran Ladies Aid

## Hillside Meets

Nine members of the Hillside Club and three guests met with Mrs. Ward Gilliland June 5. The guests were Mrs. Kermit Anderson, Mrs. Ed Grone and Mrs. Darrell Gilliland.

Secret stories were revealed and pitch furnished entertainment. Prizes went to Mrs. Herman Vahikamp and Mrs. Andrews.

Next club meeting will be in the fall.

Some Indians of the Caribbean would not eat turtles for fear such a diet would make them stupid.

Robin Reese,  
Scott Johnson  
Set Wedding Date



Mr. and Mrs. Vernon Reese of Stanton announce the engagement of their daughter, Robin Corlene Reese, to Scott Johnson, son of Mr. and Mrs. Melvin Johnson of Wayne.

Miss Reese is a 1978 graduate of Stanton High School and is employed at the Stanton Nursing Home. Her fiancé, a 1976 graduate of Wayne High School and a 1978 graduate of Northeast Technical Community College, Norfolk, is employed at Logan Valley Implement in Wayne.

The couple plans a Sept. 1 wedding at the New England Congregational Church in Stanton.

# Laura Lessmann Wins Miss Hospitality Title

Laura Lessmann of Wayne, one of 70 state finalists competing in the Miss Nebraska National Teen Ager Pageant at Concordia College in Seward Saturday night, was awarded the title of Miss Hospitality.

Robin Lynne Beavers, daughter of Mr. and Mrs. Robert A. Beavers of Gibbon, was crowned Miss Nebraska National Teen Ager at the eighth annual pageant.

Laura, 18, is the daughter of Mr. and Mrs. Merlound Lessmann of Wayne and is a 1979 graduate of Wayne High School.

As Miss Hospitality, Laura received a \$250 cash scholarship to be used at the college of her

choice, a watch and an all-expense paid trip to the 1980 pageant where she and Miss Beavers will participate in the pageant activities and program.

Laura was sponsored by the State National Bank and Trust Co. of Wayne, with over 40 Wayne businesses supporting her through their advertisement.

Congresswoman Virginia Smith was honored during the pageant by the 70 state finalists as "The Greatest Living Nebraskan."

State Director Doris A. Clanton, an English professor at Concordia College, coordinated the pageant for the 13 1/2 year old finalists who were judged on poise, personality, scholarship, citizenship, leadership and personal appearance.



LAURA LESSMANN

## Landon Grothe Baptized Sunday

The Rev. Wesley Bruss officiated at baptismal services at the Trinity Evangelical Lutheran Church at Hoskins Sunday morning for Landon Lynn Grothe.

Landon is the son of Mr. and Mrs. Lon Grothe of Hoskins. His godparents are John Bessmer of Pender and Mrs. Jerry Anderson of Norfolk.

A dinner honoring Landon was held in the Marvin Grothe home Hoskins, following the baptism. Guests were great grandparents, Mr. and Mrs. Otto Grothe and John Froehlich of Hedar, Mr. and Mrs. Lon Grothe and family, Mrs. Jerry Anderson and Cheryl Grothe of Norfolk, and John, Terry and Chris Bessmer of Pender.

## Baptized at Carroll Church

Baptized June 3 at the United Presbyterian Church in Carroll was Jennifer Amanda Owens, daughter of Mr. and Mrs. David Owens of Carroll. The Rev. Gail Axen officiated.

Mrs. Owens became a member of the church the same day. Jennifer's baptismal dress was worn by her great grandmother, the late Mrs. John Owens of Wayne, 83 years ago. Jennifer's sponsor was Megan Owens.

A cooperative picnic dinner was held afterward in the David Owens home. Guests included the Rev. Gail Axen and Mrs. Francis Axen of Stanton, Mr. and Mrs. Russell Pryor, Mr. and Mrs. Gilbert Danberg, Mr. and Mrs. Bill Carlson and Chris, Mr. and Mrs. Martin Meier and Tammy Carlson, all of Wayne, Mr. and Mrs. Francis Mitchell, Mr. and Mrs. Bob Hoffman, Mrs. Fern Jenkins and Lois Jenkins, all of Norfolk, Bonnie Owens of Grand Island, Mr. and Mrs. Al Carlson and Chad of Winside, Mr. and Mrs. Henry Langenberg of Hoskins, and Owen Owens and Mr. and Mrs. Milton Owens and Megan, all of Carroll.

## Dixon Church Has Farewell

Members of the Dixon United Methodist Church held a farewell program Sunday afternoon for the Rev. and Mrs. Bill Anderson and family.

Pastor Anderson, who has served the Dixon Church for the past three years, left with his family Monday for Florence, Ill., where he will serve as pastor of a church there. He also plans to attend school in Chicago.

Members of the church and area friends attended Sunday's farewell program and fellowship.

Vivian Hand is the new pastor of the Dixon United Methodist Church and will deliver her first sermon there this Sunday.

## Wedding Plans Fold

Making plans for a July 15 wedding at the Salem Lutheran Church, Wakefield, are Diane Tullberg and Michael Row.

The engagement and approaching marriage have been announced by the bride-elect's parents, Mr. and Mrs. Myron Tullberg of Wakefield. Parents of the bridegroom are Mr. and Mrs. P. Douglas Row of Carroll.

Miss Tullberg, a 1974 graduate of Wakefield High School, attended Doane College and was graduated in 1978 from the University of Nebraska-Lincoln, where she was affiliated with Phi Sigma Tau and Alpha Lambda Delta honoraries. She is art teacher at the Stromburg Public Schools. Her fiancé was graduated from Shickley High School in 1975. He attended Doane College and was graduated from Southeast Community College at Millard in 1978, where he was affiliated with Sigma Phi Theta fraternity. He is employed at Wheeler's Store in Geneva.

## Wayne Girl Selected To Compete

Anne Liska, daughter of Dr. and Mrs. J.J. Liska of Wayne, has been selected a state finalist in the 1979 Miss United Teen-Ager Pageant to be held at Doane College in Crete at 7:30 p.m. on June 23.

Contestants must be between the ages of 14 and 18 and must have at least a B average in school. Contestants are requested to participate in the Volunteer Community Service Program of the Miss United Teen-Ager Pageant. Through this program the youths become involved in community activities by contributing at least eight hours of time to some worthwhile charity or civic work of their choice.

The winner of the state finals will receive an all-expense paid trip to compete in the national

finals, a three phase pageant in Washington, D.C., Hollywood, Calif., and Honolulu, Hawaii, where she will compete for \$15,000 in cash scholarships, a new car, trip to Europe, \$5,000 appearance contract, \$2,000 wardrobe and other awards.

Contestants will be judged on scholastic, civic achievements, beauty, poise and personality. There is no swimsuit competition. Each contestant is also required to write and recite a 100 word essay on the subject "My Country."



ANNE LISKA

The pageant is the official state-wide finale for the Miss United Teenager Pageant.

Miss Liska, 16, is sponsored by the Wayne Veterinary Clinic. She will be a junior next fall at Wayne High School and enjoys riding horses, playing basketball and meeting new people.

Contestants from all over the state will be competing for the

## 77th Birthday Marked Sunday

The family of Mrs. Elja Ehike of Laurel gathered in the Robert Cleveland home at Winside Sunday to observe Mrs. Ehike's 77th birthday, which was June 13.

Hostesses were her daughters, Mrs. Wayne Anderson of Laurel, Mrs. Robert Cleveland of Winside, and Mrs. Darrell Graf of Belden. There are 15 grand-children and 18 great-grandchildren.

A special gift was a charm bracelet from the great-grandchildren. The birthday cake was baked by Mrs. Karl Frederick of Winside.

**WILLIAM A. KOEBER, O.D.**  
**DONALD E. KOEBER, O.D.**  
Doctors of Optometry

313 Main St. Wayne, Nebr. 68787

**COMPLETE VISION SERVICE CONTACT LENSES**

Conventional Hard Lenses  
Soft Lenses

**For Appointment Call 375-2020**  
Convenient parking beside and in rear of office

Members of American Optometric Association

Dad's style of shirts!

10<sup>99</sup>

JM McDonald's Striped Knits, reg. \$16 to \$20. Full fashioned striped shirts in boucle knit or flat knit polyester. Assorted colors, sizes S-M-L-XL.

DADS JUMP SUITS  
12 only! Short sleeve, colored. Reg. \$27.00. **\$15<sup>99</sup>**

father's day june 17

McDonald's AT WAYNE, NE.

SEE "DAD'S DAY" SECRET DISCOUNT CARD BELOW!

**SECRET DISCOUNT SALE SAVE!** 10% to 50% OFF FUN FOR DAD'S DAY!

Thursday, Friday, Saturday, is Discount Day At McDonald's

Just bring this ad to McDonald's and ask for your own "Secret Discount" Card for "Dad's Day" Gifts! A 10 percent discount may be used as often as you want, 20, 30, 40 or 50 percent only once! One Discount card per customer. Discount card valid Thursday, Friday, Saturday, June 14th, 15th, 16th.

**DISCOUNT CARD GOOD FOR MENS WEAR ONLY!**

**PSYCHOLOGY**

IF TEMPER FLARE AT A MEETING, PSYCHOLOGIST SAY YOU CAN HELP. DOE THINGS OFF CALMING, RELAXING AND SERVING REFRESHMENTS. A SIMPLE SHAKE AND A TALL GLASS OF ICE TEA CAN often HELP SOOTHE RUFFLED FEATHERS.

**Before You Buy See Us — Why?**

**L & L-Housing, Inc.**

MOBILE & MODULAR HOMES

So. Hwy. 77  
(Last Business South of South Sioux City, NE)  
Open: Monday, Friday 9 a.m. - Saturday 9 a.m., Sunday by Appointment Only  
Phone No. 402-494-5157

**New, Woodsided, Asphalt Shingled Roof, Drywall Interior Home For Only \$14,619.00**

**Champion & Bonnavilla Homes**

See Royals Play

# Laurel Teams Get Special Treat

The Laurel Midget and Legion teams had a break in the current baseball campaign this past weekend, but not because of the weather.

Both teams and their parents spent the weekend seeing how the professionals do it in Kansas City, as the Royals entertained the New York Yankees on

Sunday and the Boston Red Sox on Monday.

"We thought it would be an enjoyable trip for both the players and their parents."

Laurel coach Bob Weisenberg said, "and it was a good-break for everyone."

The Laurel Midgets were scheduled to play Bancroft on Monday, but that game was moved to Wednesday, June 13 at Bancroft.

"We saw a couple of good ball games, especially the 4-0 Kansas City loss to the Red Sox Monday night," Weisenberg said.

The Royals were successful on Sunday, with a 10-4 win over the Yankees.

"There was some fine ball playing, and we hope the boys were able to pick up some good tips to help their play," Weisenberg said.

## June 22 Final Date for Tickets

The deadline for purchasing tickets for the John Hadi talk and sports dinner at Wayne State College is June 22. Tickets for the June 28 event are available through WSC Athletic Director Dr. John Merriman at 375-2200.

Hadi, a former professional football quarterback, retired from professional football in 1978. He quarterbacked the San Diego Chargers, Los Angeles Rams, Green Bay Packers and the Houston Oilers during his career. He retired ranking as the third leading passer in the National Football League history for the most yards gained, lifetime and most passes attempted. Lifetime He ranks fourth in NFL history in touchdown passes completed.

Hadi's talk and dinner at Wayne State are open to the public. Tickets are \$10 each including dinner. An official NFL autographed football will be given as a door prize at the dinner. Proceeds from the event will be used for WSC athletic scholarships.

SEE MONDAY'S PAPER FOR SOFTBALL RESULTS



Comparing Pitching Shoes

ERWIN LONGE (right), Wayne, talks over horseshoes with Walt Hamm during the horseshoe pitching contest Sunday at the Winside Old Settlers Reunion. Ron Lager (pitching) took first place in the contest. Longe was second, Walt Lage, Carroll was third and Everett Schuetz, Stanton, fourth.

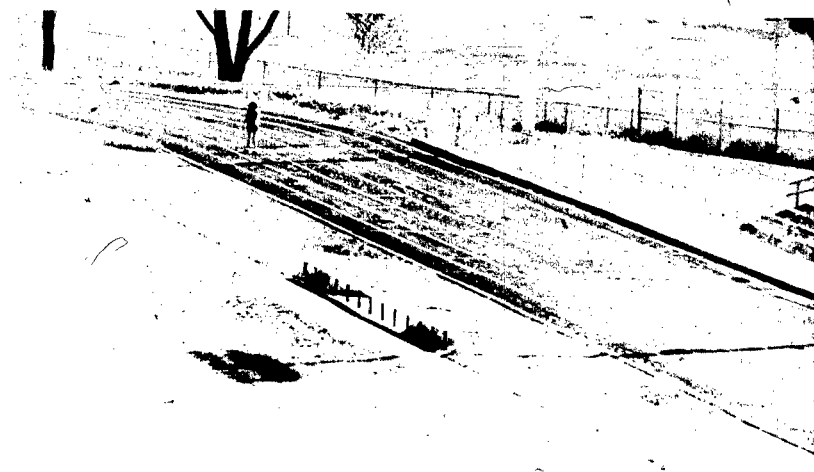

'Early Morning Cool'

A JOGGER takes advantage of a cool morning as temperatures climbed into the high 90's for the first time this

season. Interest in outside activities continues to grow as more people become aware of the advantages of exercise.

## Allen Girls Are All-Stars

A pair of Allen girls were named to the "All-Star" team at the Midland College Girls Basketball Camp held at Midland College in Fremont last week. Desiree Williams, daughter of Mr. and Mrs. Craig Williams and Stacey Koester, daughter of Mr. and Mrs. Larry Koester, both of Allen, were among 112 girls from Nebraska and Iowa participating in the camp.

At the awards banquet Friday night both Miss Koester and

Miss Williams were named to the "All-Star" team.

Desiree also received three trophies for her shooting abilities. One for the "21 shot contest," one for "Spot shooting" and one for the "Hot shot shooting contest" for which she set a new camp record.

Miss Williams was also chosen by the camp coaching staff to receive the "Outstanding Camp or Award." The award was based on her eagerness to work to accept criticism, to apply what she had learned, fairness, cooperation and attitude.

**THE LARGEST**  
 WE HAVE THE MOST TOOLS  
 WITHIN \$3.30 PER POUND'S  
 WE HAVE THE MOST TOOLS  
 WITHIN \$3.30 PER POUND'S  
 WE HAVE THE MOST TOOLS  
 WITHIN \$3.30 PER POUND'S

**MECHANICAL TOOLS**  
 WE HAVE THE MOST TOOLS  
 WITHIN \$3.30 PER POUND'S  
 WE HAVE THE MOST TOOLS  
 WITHIN \$3.30 PER POUND'S

Need a Car right NOW?

Chrysler Center  
 714 & Main Wayne  
 375-3270

## LIVE ENTERTAINMENT FRIDAY JUNE 15

THE ALL KNIGHTS  
 Playing 8:30p.m. to 1:00a.m.  
 for your dancing and listening enjoyment.



DINE WITH US FRIDAY NITE  
 PRIME RIB \$5.95

The Windmill Restaurant  
 111 West 3rd - Wayne

\$20,000  
 \$15,000  
 \$10,000

When your children go off to college, how will they measure up financially?

It takes money to put a child through four years of college. I can show you how to plan today for your children's future educational expenses through life insurance. Call me.

Get more out of life.

BILL WOELHER  
 112 W 2nd  
 Wayne



Kids Draw Attention

THE KIDS parade at the Old Settlers Reunion in Winside Sunday attracted a lot of attention. Carma and Joshua Behmer, Hoskins, won first place with their entry "Faith on the Frontier."

AMERICAN FAMILY INSURANCE  
 AUTO HOME BUSINESS HEALTH LIFE  
 American Family Life Insurance Co  
 Madison, Wis

T & C ELECTRONICS Invites You To Go On a Memorable —

# HOLIDAY FOR TWO!

YOUR CHOICE OF

<b>4 Days - 3 Nights Lodging Paid-in-Full!</b> ON THE OCEANFRONT AT DUNES HOTEL IN SUNNY <b>Miami Beach, Florida</b>	OR	<b>3 Days - 2 Nights Lodging Paid-in-Full!</b> AT THE GRAND FLAMINGO IN FABULOUS, GLITTERING <b>Las Vegas, Nevada</b>	OR	<b>3 Days - 2 Nights Lodging Paid-in-Full!</b> AT THE RUNAWAY BAY ON BREATHTAKING <b>Lake Bridgeport, Texas</b>
--	----	---	----	---

Subject to the conditions listed on the certificate. (Meals and transportation not included).

TO RECEIVE YOUR HOLIDAY FOR TWO CERTIFICATE:  
**PURCHASE ANY CONSOLE TV From T & C Electronics**

— This Would Make An Excellent Father's Day Gift —

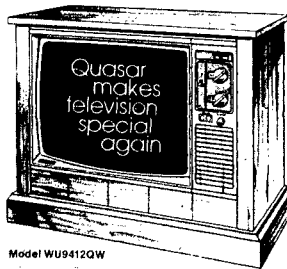

Model WU9412W  
**25" Console Color TV**

NOW ONLY  
**\$699.95**

- Includes Holiday For Two
- Dynacolor System
- Service Miser Chassis with Super Module
- Low Energy Usage
- Personal Touch Control
- Stabilized Power Supply

Quasar 19" ORIGINAL COLOR TV



Model WT9310Z  
 NOW ONLY  
**\$439.95**  
 Trip Not Included on 19" Models.

# T & C ELECTRONICS

We Service All Major Brands

214 MAIN — WAYNE, NE — PH. 375-4484

## THAT'S A FACT



GET A HORSE!  
 AN EARLY STREET CAR INTRODUCED IN 1876 HAD ITS GASOLINE MOTOR DISGUISED AS THE HEAD OF A HORSE TO AVOID SCARING REAL HORSES!

JOIN THE CLUB!  
 ALL MOST 250,000 AMERICANS THROUGH THE PAYROLL SAVINGS PLAN. SAVINGS BONDS ARE THE SAFE, DEPENDABLE WAY TO MAKE A WONDERFUL FUTURE A SURE THING AND AT THE SAME TIME, THEY GUARANTEE AMERICA'S FUTURE. TODAY SO... BUY U.S. SAVINGS BONDS. ★★★★★

NO. 1 NUMBER!

THE NUMBERING OF HORSES STARTED IN 1915, AND SO FAR, THE HIGHEST NUMBER OBTAINED BY ANY ONE HORSE IS NO. 9190 ON MAY 19, IN THE JULIUS OF MEMPHIS, MISS.

True Value HARDWARE STORES

### EDISON LANTERNS

- UNBREAKABLE • WON'T RUST
- NEVER NEEDS REPAINTING
- HINGED FOR EASY RELAMPING

Now welcome guests and discourage prowlers with these attractive colonial styled Outdoor Fixtures. Weatherproof and rustproof with clear beveled acrylic panels in matte black frame.

YOUR CHOICE \$13.99

E3126-9 E3176-9

SHERRY BROS.  
 FARM & HOME CENTER  
 Phone 375-2082

# Wayne Herald Sports

## Wakefield Legion, Midget Teams Have Up's, Down's

The Wakefield Midget and Legion teams had their ups and downs in action earlier this week. Both teams downed Pender at Wakefield Monday night, the Midgets won 7-0 and the Juniors won 10-0, but Tues-

day night was just the opposite as Wakefield dropped two to Norfolk, 4-0 in the Midget game and 5-3 in Junior action.

Mark Starzl and Rod Nixon combined for the 7-0 Midget win over Pender. Josely Shorer was the top Wakefield batter, with two hits.

In Junior action against Pender, Rick Guy, Dale Phipps and Todd Swigart all spent time on the mound to shutout the Pender Juniors 10-0.

Guy also was the most active Wakefield hitter with two hits.

"The game was not very well played," Coach Paul Eaton said, "because a number of our runs came from walks by the Pender pitchers."

The Norfolk Midgets and Juniors brought Wakefield back to the ground with a 4-0 Midget win and a 5-3 Junior victory.

"We were doing pretty good in the Midget game, but our errors hurt us," Coach Eaton said.

Wakefield pitcher Jeff Hallstrom pitched no hit ball for five innings, but allowed 3 unearned runs. Hallstrom was relieved by Mark Starzl, and a late Wakefield rally was cut short by a Pender double play.

"Errors were again the problem in the Junior game," Coach Eaton said, as Norfolk scored four unearned runs.

Rick Guy pitched four innings and was relieved by Todd Swigart against Norfolk.

Wakefield again rallied in the late innings and again the rally fell short, as they could only come up with two runs in the sixth inning.

A busy weekend is ahead for the Wakefield teams, with action Friday at Wisner, Monday at Emerson, and Tuesday against South Sioux City.

### Race Results

Even though rain canceled racing Saturday, June 9 at Jackson, Minn., three Hoskins race drivers made up for it with a big night Sunday, June 10 at Husels Speedway in Sioux Falls.

Gerald Bruggeman picked up two first place finishes and a third, in the third heat. A feature and Trophy Dash respectively.

Gene Brudigan took first place in the second heat, finished second in the Trophy Dash, and placed seventh in the A feature.

Harold Brudigan finished fourth in the first heat and sixth in the A feature.



A Winning Smile

WAKEFIELD COACH Paul Eaton wasn't all that pleased with his team's performance against Pender, but he did manage a smile as runs came across for his team to defeat Pender, 10-0. The Wakefield teams were grounded by Norfolk in later action. They will be in action Friday night against Wisner, Monday at Emerson and Tuesday against South Sioux City.

### Meet Postponed

The second annual Wildcat Golf Tournament, open to all former Wayne State College athletes and members of the Wayne Second Guessers' Booster Club, which was scheduled for June 16 has been postponed to a later date.

The new date has not been set for the event, and information may be obtained by contacting WSC Athletic Director Dr. John Merriman at 375-2200.

### NOTICE

THE 3 INCH WORK BOOT featured in our advertised circular this week, claims that is "Fully Insulated". We sincerely apologize, but such a statement is a typographical error. THE 3 INCH WORK BOOT IS NOT FULLY INSULATED. We apologize for any inconvenience this might have caused any of our valued customers.



### Defeat Emerson

## Wayne Plucks a Couple from Emerson

The Wayne Midget and Legion teams came away from Emerson with victories Monday night in Ralph Bishop action. The Midgets won 7-0 and the Legion won 6-0.

Tim Pfeiffer tossed a no-hitter and knothed 8 strike-outs as he went the full six innings and upped the Wayne Midget record to 2-1, with the 7-0 win.

Jerre Morris ripped a two-run double in the second inning to open the Wayne scoring attack, and Pfeiffer added an RBI single to top the inning's scoring

with Wayne out front 3-0.

The Emerson pitcher, Asmasen, loaded the bases in the fourth inning on walks, and walked in one run, which set the stage for Skokan's two-run single, putting Wayne on top 6-0.

Wayne added one more run in the fifth as Brian Fleming scored on an Emerson error.

Emerson was allowed only two base runners the entire game, one in the first on an error and another in the third on a walk.

Dennis Carroll allowed only

two Emerson hits, while the Wayne Juniors pounded out 11 hits in the 6-0 victory.

Jeff Zeiss, Tim Thomas and Tom Ginn each had two hits to pace the Wayne attack.

Zeiss opened the third inning with a single and sparked Wayne to a total of five hits and six runs in the inning. Wayne sent 12 batters to the plate in the third, as Zeiss, Carroll and Ginn each batted twice.

Dennis Carroll, Dean Carroll, Dion, Goeden and Schwartz each added singles to the Wayne hitting attack.

Scott Koeppel and Rick Rush were the only Emerson batters to hit safely.

Next action for the Wayne team is scheduled for Friday June 15 at Winside.

Wayne Midgets 030 301 - 751  
Emerson 000 000 - 004

WAYNE AB R H

Morris 4 1 2

Pfeiffer 2 1 1

Fleming 0 1 0

Brink 0 1 0

Lindsay 2 1 0

Nelson 1 0 0

McCright 2 0 1

Skokan 2 1 1

Moore 0 0 0

Brandt 3 1 0

Virtala 1 0 0

Baier 3 0 0

Totals 22 7 5

Wayne Juniors 004 000 - 4 11

Emerson 000 000 - 0 7

WAYNE AB R H

Zeiss 4 1 2

Carroll 4 1 1

Ginn 4 1 2

Mitchell 5 1 0

Schwartz 5 1 1

Gansebarn 3 0 0

Dion 1 0 1

D. Carroll 2 1 1

Goeden 3 0 1

Sperry 1 0 0

Thomas 3 0 2

Totals 35 6 11

### Deadline Set

The last day to register to participate in the Wayne State College Pro-Am Golf Tournament, scheduled for June 29 at the Wayne Country Club will be June 22.

Nearly 30 professionals from the Nebraska Section of the Professional Golf Association (PGA) have registered for the tournament. The professionals will compete for a cash purse of \$1000, while participating amateurs compete for various trophies and prizes, including a chance for a 1979 Chevrolet Citation. One professional will participate throughout the tournament with each group of three amateurs.

Tickets are still available for interested amateurs. A \$50 entry fee is required and includes lunch, an evening dinner, 18 holes of golf and entry into the tournament. Proceeds will be used for WSC athletic scholarships. For ticket information contact Del Stollenberg or Ralph Barclay at 375-2200.

The event is sponsored through WSC and the Wayne Second Guessers' Club.

### Order Booster Sweater Today

The Wayne Carroll Athletic Booster Club will order booster sweaters, Thursday, June 14 at the Wayne Carroll High School library between 4:00 and 8:00 p.m.

You need not have a child in sports, all you need is an interest in the Wayne Carroll athletic program.

You may try on sweaters before ordering and if you can not make it during the time set, just contact Vicky Skokan at 375-3404 to make other arrangements.

FOR FATHER'S DAY ALL GOLF SHIRTS \$12.00

\$16 - \$20.00 Values

Etonic - Silver Fox



Rudy's Pro Shop

WAYNE COUNTRY CLUB

## NOBODY BEATS TOUGH FORD PICKUPS FOR GAS MILEAGE!

\$4,995<sup>00</sup>

'79 FORD F-100 Six cylinder with 4-speed overdrive transmission.

HIGHEST EPA RATING

18 MPG CITY 24 MPG HIGHWAY EPA ESTIMATE\*

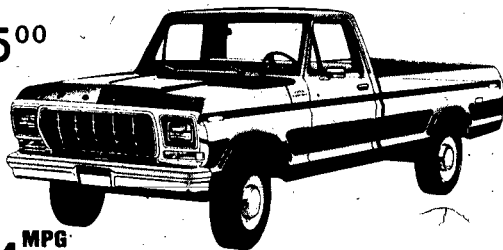

HIGHEST EPA RATING

27 MPG CITY 37 MPG HIGHWAY

EPA ESTIMATE\*



'79 FORD COURIER With 2.0 liter engine, 5-speed transmission.

Nobody beats our Pacesetter Buys on high-mileage Pacesetter trucks!

\*Use for comparison purposes. Your mileage may differ depending on speed, weather, trip length. Highway mileage will probably be lower.



## '79 FORD PACESETTERS

See your local Ford dealer

Arnie's Ford-Mercury 375-3780 119 East 3rd Street Wayne, NE.

## OUR 10TH ANNIVERSARY SALE CONTINUES



BIG DUFFER

# BIG DUFFER

SINK YOUR TEETH INTO A DELICIOUS BIG DUFFER:

Two 100% Pure Beef Patties on a three piece toasted sesame seed bun with two slices of super cured cheese, coarse lettuce, tomato, and our own special dressing! A MEAL All By Itself!

### BIG DUFFER SPECIAL

Friday-Saturday & Sunday June 15-16 & 17

BUY ONE BIG DUFFER at Regular Price, and get the SECOND BIG DUFFER at 1/2 PRICE

A SAVINGS OF 59¢

## Lil' Duffer

Family Restaurant

7th and Main Phone 375-1900 Wayne





### Bridal Shower

#### Held at Concord

Mrs. Bob Meyer of Lawton, Okla. was guest of honor at a bridal shower Sunday at St. Paul's Lutheran Church, Concord.

Sixty guests attended from Kansas City, Kan.; Rock Valley, Ia.; Narragansett, R.I.; Pender, South Sioux City, Concord, Dixon, Allen, Emerson, Laurel, Coleridge and Altona. Decorations were in blue and yellow.

The program included devotions and a reading by Mae Rueter, a piano duet by Sheila Koch and Lori Rastede, and a humorous reading and closing prayer by Marge Rastede.

The bridegroom's sister, Mrs. Ken Force of Narragansett, R.I., assisted with the gifts.

Hostesses were Delores Koch, Francis Kraemer, Johene Kraemer, Donna Stalling, Sharon Anderson, Karen Blohm, Margareta Blohm, Marge Rastede, Tillie Rastede, Lois Witte, Diane Blohm and Agnes Serven.



Club Donates \$500

INDIVIDUALS and organizations of the Allen community have been donating hundreds of dollars during the past months to help purchase a new rescue unit for the Allen-Waterbury Fire and Rescue Squad. One of the most recent contributors is the Allen Community Development Club. Rex Fisher, at left, is pictured presenting a \$500 check from the Community Development Club to Fire Chief Jerry Schroeder. Donations for the new rescue unit are being accepted at the Security State Bank in Allen or by any member of the Allen-Waterbury Fire Department.

## HOSKINS NEWS

Mrs. Hilaa Thomas 565-4569

### Former Resident Speaks

Mark Zander, formerly of Hoskins, was guest speaker during worship services Sunday at the Trinity Evangelical Lutheran Church, Hoskins.

Zander was honored during a congregational dinner following the worship service.

Zander, son of the late Oscar and Irma Zander, attended Trinity Lutheran School in Hoskins through eighth grade. He graduated from the Lutheran High School of New Ulm, Minn. and from Northwestern Lutheran College in Watertown, Wisc. He completed his schooling at the Wisconsin Lutheran Seminary at Mequon, Wisc.

He has been assigned to serve the Garden of Gethsemane Lutheran Church in Omaha.

**Install Officers**  
Officers of the Walther League were installed during worship services Sunday at the Zion Lutheran Church.

The new officers are Lisa Welch, president; Mick Meyer, vice president; Wendy Freeman, secretary; Ryan Saegerbarth, treasurer; Brad Freeman, Christian growth chairman; Todd Koepke, Winesedge chairman; and Roger Saegerbarth, news reporter.

Sunday evening the League sponsored a congregational picnic at a park in Pierce.

**Attend Camp**  
—Pam Peter, Mary Wantoch, Ellen Wockman, Kathy and Patty Gnirk, Mike Mumm, Erin Marozt, David Cheney and the Rev. and Mrs. Wesley Bruss and families, all of Hoskins, and Brenda Jussel of Wayne attended Camp Messiah June 3-8.

### IN HOSKINS

A newer 3 bedroom home, close to school, church and downtown. (F1192)

Call our office for more information on this home or any of our other homes in Randolph, Plainview, Bloomfield, Creighton, Neligh, Battle Creek, Stanton, Madison, Wausa, or...

**Century 21**  
FISHER REALTY  
Locally owned and operated  
566 Madison Ave.  
Phone 371-2858  
Anytime Day or Night

**FOX PHOTO COUPON**  
Developing & Printing  
**COLOR PRINT FILM**

12 Exposure Roll	\$1.98
20 Exposure Roll	\$2.98
24 Exposure Roll	\$3.49
36 Exposure Roll	\$4.09

On any 110, 126, or 35mm color print roll film, (C-41 process only - includes all popular films). Exp. Date 6-22-79

**GRIESS REXALL**  
Next to Wittig's IGA

## ALLEN NEWS

Mrs. Ken Linafelter 635-2403

### Benefit Bake Sale Planned

The Gasser Post VFW Auxiliary of Martinsburg is planning a benefit bake sale for the Marilyn Karibergs on Saturday, June 16, from 9 a.m. to noon at Martinsburg Coffee and baked goods also will be served.

All members are asked to bring baked goods.

**Museum Open**  
The Dixon County Historical Museum, located in Allen, will be open this Sunday afternoon from 2 to 4.

Hosts will be Fern and Chester Benton.

**Cancer Fund**  
Mrs. Ernest Stark, chairman for the Springbank Township Cancer Fund, announces that all cancer envelopes have been returned. Nearly \$100 was collected this year, slightly more than last year.

**Picnic Held**  
A picnic was held at the Allen park Sunday evening. Attending were the Lyle Rainforth of Wood River, the Sam

Currys of Ponca, the Herbert Ellises of Sioux City, Naomi Ellis and the Harold Ison family of Allen, the Steve Von Minden family of Ponca, Marcia McAfee of O'Neill, the Pat Irishes of Sioux City, Mike Ellis of Allen, and the Rev. and Mrs. Galan Burnett and Miriam of Allen.

**Meeting Postponed**  
The June 11 meeting of the Lucky Lads and Laddies 4-H Club has been postponed until Saturday, June 23, when club members and their families plans a camp-out at Ponca State Park.

**Riding in Rodeo**  
The Golden Spur Saddle Club is planning to ride in the Ponca Rodeo on Saturday, June 23. Members are to meet in Ponca at 1 p.m.

The club plans a trail ride this Sunday afternoon at 2:30 at Maskett, sponsored by Elmer Burcharm. Those attending are asked to furnish finger foods for a lunch afterward. For more

information contact Ken Pettit or Mike Isoms.

**Extension Club**  
The Allen Community Home Extension Club met Friday afternoon in the home of Sylvia Whitford. For roll call, members told 10 things they do in the morning for exercise.

The club voted to donate \$100 to the Allen-Waterbury rescue squad for the purchase of a new rescue unit.

The club will not meet again until September.

**Social Calendar**  
Thursday, June 14: Sandhill Club, Carol Ann Carlson, 2 p.m.; Bid and Bye Club, Mil McCord, 2 p.m.  
Tuesday, June 19: Dixon County Historical Society, county museum, 8 p.m.  
Thursday, June 21: Allen Young Homemakers potluck picnic lunch, Allen park, 4 p.m.  
THU Extension Club, Mil Fahrenholtz, 7 p.m.

### Service Buddies Meet in Omaha

Mrs. Keith Hill and Mrs. Josie Hill were in St. Paul, Minn. June 5-7 to attend the high school graduation of Mrs. Josie Hill's granddaughter, Susan Hill, daughter of Dr. and Mrs. Ed Hill of Minneapolis. Susan graduated with service honors and received the John Phillip Sousa Band Award.

The Ken Linafelters and Mrs. Ardith Linafelter spent Thursday to Saturday in Lincoln with the Clayton Schroeders. The Ken Linafelters attended the annual conference of the Nebraska United Methodist Church.

Kim Isom, Kearney, and Mitch Elliott, Odesa, were weekend guests of Kim's grandparents, the Claren Isoms.

Darrell Harrison attended a reunion of the 265th ordnance at Howard Johnson Hotel in Omaha during the weekend. About 45 attended from the surrounding areas.

The weekend included a get-acquainted day Friday, a banquet Saturday, and a farewell breakfast Sunday.

The men who went in the service together in 1942, had not seen each other for 35 years.

"Man is made by his belief. As he believes, so he is." Bhagavad-Gita

**Give Dad our best on FATHER'S DAY, JUNE 17**

**COORS Taylor**  
12 PAK \$374 Calif. Cellar Wine  
FIFTH \$180

**RAIN TREE** Drive In Liquor  
5th & Main — Wayne — Ph. 375-2090

# FATHER'S DAY

the spotlights on Dad!

**JUNE 17th**

## Father Knows Best ...

**SLACKS For Every Occasion**

**\$15.50 - \$27.50**

- ★ Farah
- ★ H.I.S.
- ★ Higgins

The all American, all classic look.

**Arrow KENT BURMA**

The dress shirt for the man with a no nonsense attitude toward his attire. Regularly cut for the average American man. 7 button front. Not Burma collar. Easy care polyester and cotton fabric. Colors and patterns to suit any suit in the every time. Come in and take a serious look at our collection.

**Winning Summer Wear**

We got 'em Dad... all the active and leisure styles you love to wear. Surber's has it all for Dads...

**Father's Day Special**

Arrow Short Sleeve Dress Shirts Values to \$15-\$16 During Father's Day \$9.99

Dad's Special Shoe **DEXTER** Make Dad's Day Super Special \$28.00

**Gifts for Dad**

**SURBER'S SURBER'S**

Bev Deederman, vice president; Anne Norrth, secretary, and Carolyn Backsins, treasurer. Jay Muller of Clarkson spoke on African violets and demonstrated how to remove extra growth plants. Plans were presented to the outgoing officers.

Next meeting will be with Betty Bronzynski on June 28 and will feature a mini violet show for prospective new members.

Following Thursday's meeting, the club toured the iris gardens of Roger Nelson and Jim Hummel.

**Meet at Church**  
The Ladies Aid of Zion Lutheran Church met at the church last Thursday afternoon. Hostesses were Mrs. Mel Freeman and Mrs. Frieda Bargstadt, and guests were Mrs. William Gosch and Mrs. A.G. Deke.

Mrs. Mel Freeman, president, opened the meeting with prayer. For roll call, members donated two cents to the penny pot if they have had fresh vegetables from this year's garden and three cents if they have not.

Reports were given by secretary Mrs. Elaine Ehlers and treasurer Mrs. Ralph Kruger. A report also was given by the card committee.

It was announced that several members plan to attend the LWML convention in Omaha on July 17.

The flower committee for June is Mrs. Fred Bargstadt and Mrs. Frieda Bargstadt. Named to the Altar Guild committee for July were Mrs. Ralph Kruger and Mrs. Bill Koepke.

The Rev. A.G. Deke presented the topic, entitled "Confidence or Doubt," and the meeting closed with prayer.

Next meeting will be July 5 with hostesses Mrs. Clemens Weich and Mrs. Don Walker.

**Dorcas Society**  
Gladys Reichert was hostess when the Dorcas Society of the Peace United Church of Christ met Thursday afternoon at the church. Mrs. George Witter, Mrs. Fred Johnson and Mrs. Lena Ulrich were guests.

Mrs. Alfred Vinson, president, opened the meeting with a poem, entitled "I Forgot My God," followed with group singing. Members responded to roll call with a scripture verse.

Mrs. Norris Langenberg read the secretary's report and Mrs. George Langenberg Sr. gave the treasurer's report. A cheer card was sent to Mrs. Carl Brahn.

Mrs. Erwin Ulrich, assisted by Mrs. Norris Langenberg, presented the Bible study, entitled "The Woman I Don't Want to Be," with all members participating.

Mrs. Erwin Ulrich will be hostess for the July 5 meeting and Mrs. Alfred Vinson will give the program.

**Zion Lutheran Church (A.G. Deke, vacancy pastor)**  
Sunday: Sunday school, 9:45 a.m.; worship, 10:45.

**Peace United Church of Christ (Carl Brandt, vacancy pastor)**  
Sunday: Worship, 9:30 a.m.; Sunday school, 10:30.

**Trinity Evangelical Lutheran Church (Wesley Bruss, pastor)**  
Thursday: Guest day at St. Paul's, Norfolk, 9 a.m.  
Sunday: Worship with communion, 9 a.m.  
Monday: Pre-convention delegate conference at Fremont, 9 a.m.

The Erwin Ulrichs went to Sioux City last Thursday and remained overnight in the Dr. M. Gene Ulrich home. Mrs. M. Gene Ulrich underwent major surgery Friday morning in a Sioux City hospital.

### Leys Confused At Westminster

The Wayne Herald Monday published a story announcing that Jonathan Henry Ley, son of Mr. and Mrs. Henry E. Ley of Wayne was graduated recently from Westminster College in Fulton, Mo.

### 32 at Shower

### Sunday for Sandra Bowers

Relatives honored Sandra Bowers Sunday afternoon during a bridal shower at the Carroll Methodist Church. Thirty-two attended from Norfolk, Carroll, Belden, Randolph, Laurel and Creighton.

Games furnished entertainment, a baton performance was given by Deanna Willis of Winside. Tracy Eckert of Pierce and Deanna Willis assisted with the gifts and the bride's mother poured.

Hostesses were Mrs. Marvin Eckert of Pierce, Mrs. Herb Willis of Winside and Mrs. Don Harmer of Carroll.

Miss Bowers and Richard Becker will be married at St. Francis Catholic Church in Randolph on June 30. Their parents are Mr. and Mrs. John Bowers of Carroll and Mr. and Mrs. Paul Becker of Randolph.

### Group Protests

### Students' Driving

Eight persons appeared before the Wayne-Carroll Board of Education at its regular meeting Monday night to protest dangerous driving by students. They requested the board to work with the city council in policing the situation.

The board said it would investigate the matter and take appropriate action.

The news release, which was sent from Westminster College's public relations department, confused Jon with a graduating senior with the same surname.

Jon, of Wayne, has just completed his sophomore year at Westminster. He is expected this summer as a college intern in the office of Senator J.J. Exon in Washington. To qualify for the intern program, students must spend at least six weeks working in the senator's office. During that time the intern selects a topic connected with the senator's work on a subcommittee and writes a research paper on that topic.

Jon has selected the energy problem for his research project.

Jon will return for his junior year at Westminster this fall.

### Couple Surprised

### At Winside Church

Friends and relatives surprised Mr. and Mrs. Dennis Evans of Winside last Thursday, honoring the couple's 15th wedding anniversary. The event was held at St. Paul's Lutheran Church with 45 attending.

The program included musical entertainment by Mr. and Mrs. Dan Hansen, a dance by Ron Sebade and Cyril, Dan and Kelly Hansen, and a skit. The anniversary cake was baked and decorated by Mrs. Dennis Swanson of Norfolk.

Mrs. Walter Bleich of Wausau cut and served the cake. Mrs. Nonie Dempsay of Norfolk poured and Irene Damme of Winside served punch.

Friends and relatives attended the event from Missouri; Florida; New Mexico; Norfolk, Hoskins, Wayne, Carroll, Harrington, Coleridge, Piller, Laurel and Winside.



### HOSPITAL NOTES

#### Meal Program Begins

NEARLY 40 persons turned out for the first day of the new congregate meal program Monday at the Senior Citizens Center in Wayne. Meals, which are prepared daily by the staff at Providence Medical Center, are transported to the Senior Citizens Center in the center's new, mini bus. In the top photo, Dorothy Hubbard, at left, a member of the kitchen staff at PMC, and Marci Thomas, hospital administrator, help dish up the dessert. City administrator Darrell Brewington, bottom left photo, welcomes persons who attended the noon meal Monday, including Dr. and Mrs. Walter Bentback, Gary Van Meter, Wayne, Caray Drake, Carroll; Pearl Berteloth, Laurel; Ann Marie Hansen, Wayne; Margie Meyer, Wayne; Steve Glassmeyer, Wayne; Anna Hansen, Laurel; Evelina Johnson, Concord; LuLu Schuler, Wayne.

**WAKEFIELD**  
**ADMISSIONS:** Anna Stalbaum, Emerson; Peggy Kubik, Wakefield; Walter Chinn, Wakefield; Bertha Jepson, Emerson; Verna Mae Rohde, Carroll; Edna Ockander, Wakefield; Lorna Pearson, Wakefield; Sigrid Tullberg, Wakefield.  
**DISMISSALS:** Candess Headlee and Infant son, Emerson; Helen Botger, Emerson; Bertha Jepson, Emerson; Dennis Carlson, Laurel; Elmer Felt, Wakefield.

**WAYNE**  
**ADMISSIONS:** Sterling Carnes, Carroll; Frank Flier, Winside; Lynell Billheimer, Laurel; Steve Glassmeyer, Wayne; Martha Sleckmann, Wayne.  
**DISMISSALS:** Chris Nau, Wayne; Caray Drake, Carroll; Pearl Berteloth, Laurel; Ann Marie Hansen, Wayne; Margie Meyer, Wayne; Steve Glassmeyer, Wayne; Anna Hansen, Laurel; Evelina Johnson, Concord; LuLu Schuler, Wayne.



#### Dinner-Dance

##### Slated at Country Club

Wayne Country Club members and their families are invited to attend a "Chickens and Chicks" potluck dinner and dance on Saturday, June 23.

Chicken, chips, bread and refreshments will be furnished. Each family is asked to bring one side dish and their own table service. Dinner begins at 6:30, with dancing afterward.

Cost of the event is \$2 per adult and \$1 for each child. Reservations must be made by noon on Wednesday, June 20, by calling Diane Runestad, 375-1068; Shari Paige, 375-3279; Jan Liska, 375-1254, or Kathy Hillier, 375-1704.

#### Former Hoskins

#### Woman Hospitalized

Mrs. Fred Key of Mesa, Ariz., formerly of Hoskins, underwent open heart surgery June 4 at a Phoenix, Ariz. hospital. Mrs. Key is the former Verna Voss. Mail will reach her if addressed to 5244 Lindstrom Lane, Mesa Ariz. 85205.

**FOR SALE BY OWNER**

Located one mile north and 1/2 mile west of Wayne in Muhs Acres. Split bays entrance, carpeted, central air, no city water, well installed. Nearly 1 acre lot. Priced to sell. Shown by appointment only. Call 375-1912 after 6 p.m.

# WE ARE NOW OPEN

## ... See Us For

### SAVINGS

### LOANS

Type	Rate	Annual Yield	With Interest
<b>Passbook Type Installment Certificates</b>	<b>No Minimum</b>	<b>6.25%</b>	<b>6.54%</b>
<b>1 Year Certificates</b>	<b>[\$100 minimum]</b>	<b>6.50%</b>	<b>6.92%</b>
<b>2 Year Certificates</b>	<b>[\$100 minimum]</b>	<b>7.00%</b>	<b>7.18%</b>
<b>3 Year Certificates</b>	<b>[\$100 minimum]</b>	<b>7.25%</b>	<b>7.44%</b>
<b>4 Year Certificates</b>	<b>[\$100 minimum]</b>	<b>8.00%</b>	<b>8.24%</b>
<b>8 Year Certificates</b>	<b>[\$1000 minimum]</b>	<b>8.25%</b>	<b>8.50%</b>
<b>26-Week Money Market Certificates</b>	<b>[\$10,000 minimum]</b>	Rate is subject to change weekly but pays 1/4% higher than any Savings and Loan or Bank.	

Substantial Penalties for Early Withdrawal

- Second Mortgages
  - Automobiles & Trucks
  - Farm Machinery
  - First Mortgages
  - Business & Business Equipment
  - Home Improvement
  - Personal Loans
- Experienced loan counselors welcome the opportunity to work with you in arranging loans that are tailored for your convenience.

**First Savings pays higher interest rates than ANY Bank or Savings & Loan**

**STOP IN OR CALL TODAY**

# First Savings Co. of Wayne

A First National Holding Co. Subsidiary

703 Main Street

Wayne, NE

Phone 375-2590

An Industrial Loan & Investment Company Chartered by the Nebraska Department of Banking and Finance

### Hoskins Bride Honored

Fifty six guests from Hoskins, Norfolk, Stanton, Plainview and Winside honored bride-elect Diane Puls of Hoskins at a miscellaneous bridal shower Friday evening.

Hostesses for the event, which was held at the Peace United Church of Christ, Hoskins, were Mrs. Harold Wittler, Mrs. Marvin Kleensang, Mrs. Carl Mann, Mrs. Vannan Behmer, Mrs. Norris Lanzberg, Mrs. Orville Anderson, Mrs. Walter Srate, Mrs. Ed Gnirk and Mrs. Willard Kleensang, all of Hoskins. Mrs. Dallas Puls of Winside and Mrs. Michael Jones of Norfolk.

Decorations for the fête were in blue and white. The program included a skit by Mrs. Michael Jones and Mrs. Dallas Puls.

Assisting with the gifts were Renee Puls, Celeste Stephens and Gigi Hardin. The bride's mother poured.

Miss Puls, daughter of Mr. and Mrs. Dennis Puls, and

Reginald Gnirk, son of Mr. and Mrs. Robert Gnirk, all of Hoskins, will be married July 4 at the Peace United Church of Christ.

### Horse Show Set For July 1

The Wayne Saddle Club Horse Show will be held Sunday, July 1, beginning at 10 a.m. at the Wayne County Fairgrounds.

Northeast Nebraska Saddle Club rules will prevail for the show.

There will be performance and halter classes winning and three placing trophies. There will be many events with entry fees divided 30 percent, 20 percent and 10 percent.

The judge will be Ethel Anderson, Alta, Ia.

For information call Alvin Anderson, Wayne, 375-1972 or Sandra Luft, 375-1125.

SUNDAY JUNE 17  
 MAKE DAD HAPPY WITH  
 Russell Stover Candies

ASSORTED CHOCOLATES

## GRIESS REXALL

507 Main St. Wayne, Ne.  
 Next to Wittig's IGA

## Many Trees Damaged By Lightning Strikes Each Summer

Many trees are lost or damaged each summer from lightning strikes. Lightning injuries to trees are extremely variable and appear to be governed by the voltage of the charge, the moisture content of the part of the tree struck and the species of tree involved.

The woody parts of the tree may be completely shattered, then may burn. A thin strip of bark running parallel to the wood fibers down the entire length of the trunk may be burned or stripped off.

The internal tissues may be severely burned without exter-

nal evidence, or part or all of the roots may be killed. The upper trunk and branches of evergreens may be killed outright, while the lower portions remain unaffected.

In crowded groves, trees close to the one directly hit may also die. In many cases, grass and other vegetation growing near the stricken trunk will be killed. So-called "hot bolts" with temperatures above 25,000 degrees Fahrenheit will make an entire tree burst into flames, while "cold" lightning can make it literally explode as it strikes at 20,000 miles per second. On occasion, both types apparently cause no damage, but months later the tree dies from burned roots and internal tissue damage.

Tall trees or those growing alone in open areas and trees with roots in moist soils or those growing along bodies of water are most likely to be struck. Though no species of tree is totally immune, some are definitely more resistant to lightning bolts than others. Birches, for example, are rarely struck, whereas elm, maple, oak, pine, ash and cottonwood are commonly hit. The reasons for the difference in susceptibility is not

clear. Some authorities attribute the variations to the composition of the trees. Trees high in oils (birch) are poor conductors of electricity, whereas trees high in starch content (ash, maple, oak, etc.) are good conductors. In addition, deeprooted or decaying trees appear to be more subject to attack than are shallow rooted or healthy trees.

It is commonly believed that lightning never strikes twice in

the same place. This is not true, for some trees have been struck by lightning as many as seven times, judging from the scars on their trunks.

To repair an injured tree, inspect it carefully before attempting to fix the damage. Many trees are severely injured internally or below ground, despite the absence of external symptoms and will soon die regardless of treatment. Do not undertake expensive treatments

until the tree appears to be making a good recovery.

Where external damage is not great or where the tree is particularly valuable, several immediate measures are justifiable. Tack on and cover with burlap any long thin pieces of bark that have been split or lifted from the sapwood. Carefully remove shattered limbs and torn bark. Place fertilizer around the root area to stimulate vigorous growth.



Always a Sparkling Sight

THE WINSIDE American Legion Post 242 provided the honor guard for the Old Settlers Reunion parade Sunday. The parade was postponed from Saturday because of the weather. Sunday, however, turned out to be ideal.

## Council Approves New Subdivision

The city council Tuesday night approved a resolution regarding Western Heights subdivision, pending a satisfactory agreement between the city and James Coan, subdivider.

The subdivision is 8 of an acre and covers four lots. The city will determine the fee for the park requirements and then strike an agreement with the subdivider.

WHO CAN UNSCRAMBLE ANY INSURANCE?

LOOK NO FARTHER LOOK HERE

**PIERSON INS. AGENCY**  
111 West 3rd Phone 375-2696

## Free picnic and patio gifts for Columbus Federal summer savers

Now, get these coordinated Lemon 'N Lime picnic and patio accessories for summertime outings. Just add to your savings at Columbus Federal, in the amounts shown below or open a new account and select your premium from our special selection.

- A. Thermos SunPacker**  
Attractive 11-quart personal cooler with reversible tabletop-drink caddy feature. Ideal for auto or boat.
- B. Thermo-Serv 55 oz. Server**  
Double-wall insulated. Top-rack dishwasher safe.
- C. Ice Bucket**  
By Thermo-Serv. Insulated 1 qt. size.
- D. 1-gal. Thermos Jug**  
Rugged, rustproof plastic, fully insulated and attractively colored.
- E. Insulated Tumblers**  
Set of four 12-oz. tumblers by Thermo-Serv. Sparkling white stripes and yellow; white and lime. Top-rack dishwasher safe.

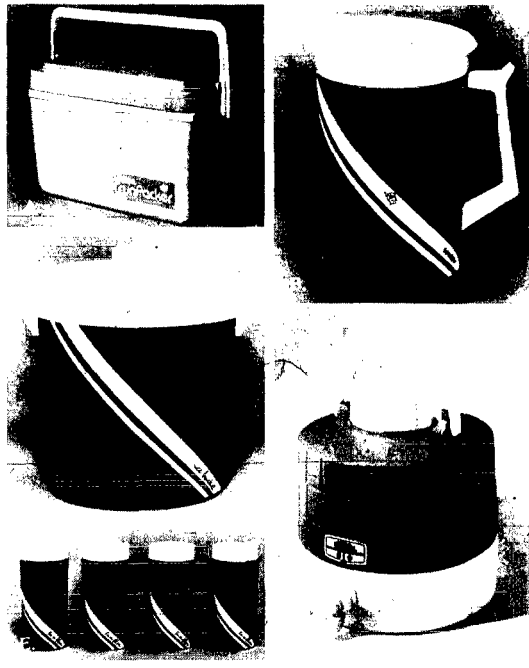

	Save \$5,000	Save additional \$200
SunPacker (A)	FREE	\$10.95
Server (B)	FREE	8.95
Ice Bucket (C)	FREE	10.95
	Save \$350	Save additional \$200
Gallon Jug (D)	FREE	\$ 5.95
Tumblers (E)	FREE	5.95



Wherever you're headed this summer, we can help you get there!

- COLUMBUS**  
14th St. & 26th Ave.  
564-3234
- FREMONT**  
Hwy. 30 East  
727-5451
- SEWARD**  
310 North 5th St.  
643-3631
- WAYNE**  
220 West 7th St.  
375-1114
- YORK**  
9th St. & Lincoln  
362-6631



# The Parable of Chewing Gum Man\*



It was common knowledge among his colleagues that William Wrigley, Jr. attributed the success of his chewing gum empire to constant and forceful advertising.

Once he was traveling to California on the famous but now extinct Super Chief with a young accountant from his firm. As they were reviewing the figures for a quarterly statement, the young man said, "Sir, Wrigley's gum is known and sold all over the world. We have a larger share of the market than all of our competitors combined. Why don't you now save the millions you are spending on advertising and shift those dollars into the profit column for the next quarter?"

Wrigley thought for a moment and then asked "Young man, how fast is this train going?"

"About sixty miles an hour," replied the young accountant.

And Wrigley asked, "Then why doesn't the railroad remove the engine and let the train travel on its own momentum?"

**Moral:** Cut your promotional dollars and you cut your own steam. Keep your momentum going

with a regular advertising program in

**THE WAYNE HERALD**  
PHONE 375-2600



**THE JUNE**  
**HOT SALE**  
**HOT DAYS**  
**Call For**  
**HOT DEALS!**

(P.S. Our Drinks Are Cold  
 Thursday, Friday, & Saturday.  
 See You Then!)

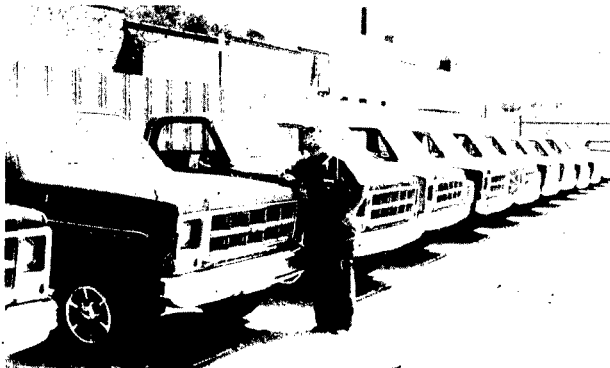

LET HARLAN "DEADEYE" FARRENS show you the large selection of new 4x4 Pickups in stock at Ellingson Motors. Buy now while the selection is big.



**1975 GMC SIERRA GRANDE**  
 4x4 4-ton, automatic transmission, power steering, fine condition.  
 Only \$3,995.00



**1974 CHEVROLET CUSTOM DELUXE**  
 4x4, automatic, power steering, a real clean one owner, 30,000+ miles.  
 Priced To Sell At \$2,750.00

**OUR USED PICKUPS ARE RARIN' TO GO...**  
 and at these prices they won't last long!



**1976 GMC SIERRA GRANDE**  
 4x4, automatic, power steering, gauges, new tires, low mileage and clean  
 Only \$4,250.00



**1976 GMC SIERRA GRANDE**  
 4x4, automatic, power steering, gauges, new tires, low mileage and clean  
 Only \$4,250.00



**1976 CHEVROLET CUSTOM DELUXE**  
 4 Wheel Drive, power steering, 4 speed transmission with lockouts, local one owner, low mileage  
 Don't Pass This Up At Only \$3,995.00

**—TOP QUALITY ELLINGSON-USED CARS—**

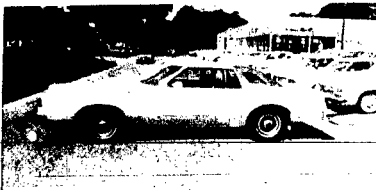

**1978 FORD LTD II COUPE**  
 Automatic transmission, power steering, air, vinyl roof, wire wheel covers, tilt wheel, cruise, AM-FM stereo, 8,200 miles, local one owner. Was \$5,095.  
 A Real Bargain at \$5,150.00



**1974 Mercury Cougar XR7**  
 Automatic transmission, power steering, air, vinyl roof, cruise, split seat, tilt wheel, AM-FM 8-track stereo, sport mag wheels, smooth running and extra clean. Was \$2,995.  
 Sale Price \$2,595.00



**1976 PONTIAC GRAND PRIX**  
 Automatic transmission, power steering, air, tilt, cruise, vinyl roof, rear window defogger, mag wheels, local one owner, real tight and quiet. Was \$4,195.  
 Always a Better Buy at Ellingson's \$3,740.00



**1977 BUICK ELECTRA**  
 Automatic transmission, power steering, air, vinyl roof, tilt, cruise, chrome wheels, power split seat, power windows, power door locks, AM-FM stereo with built in C.B., new radial tires, a super luxury car, sharp, one owner. There is not a better buy anyplace. Was \$6,695.  
 Only \$5,425.00

**MANY MORE Quality CARS & PICKUPS at similar savings, on hand. OUR SELECTION IS FANTASTIC!**



**1977 FORD THUNDERBIRD**  
 Automatic transmission, power steering, air, vinyl roof, wire wheel covers, tilt wheel, cruise, AM-FM stereo, split seat, 20,065 miles, local one owner, nice as they come, test drive for comfort. Was \$5,495.  
 Reduced to Sell at \$5,100.00

**Shop at ELLINGSON MOTORS before You Buy!!**

**"YOUR FULL SERVICE-DOWNTOWN GM DEALER"**

**Ellingson MOTORS, INC.**

• CADILLAC • GMC • BUICK • PONTIAC •

Phone 375-2355

Wayne, Ne.

West 1st St.

**OBITUARIES**

**Fanchen Banister**

Services for Fanchen Banister of Wayne were held Tuesday at the First United Methodist Church in Wayne with the Rev. Kenneth Edmonds officiating. Burial was in Greenwood Cemetery, Wayne. Mrs. Banister died Friday in Omaha. Honorary pallbearers were Paul Rogge, Cletus Sharer, Al Kopin, Martin Willers, Dr. Robert Bentback and August Lorenzen. Active pallbearers were Charles Surber, William Kugler, Alvin Gerner, Robert Pann, Marilyn Koch and Arnie Reeg.

Fanchen Phyllis Banister, the daughter of Albert and Bertha Hoskinson, was born Oct. 15, 1907 at Foster, Ia. She moved to Wayne with her family in 1924, and was united in marriage to Richard H. Banister on Sept. 3, 1925 at Wayne, where the couple made their home. Mrs. Banister was a seamstress for many years. She was a member of the First United Methodist Church, United Methodist Women and Royal Neighbors.

She is preceded in death by her parents, her husband, two brothers and one sister. Survivors include one son, Richard Banister of San Diego, Calif., three grandchildren; one sister, Mrs. Burteen (Hope) Nunemaker of Laurel; and several nieces and nephews.

**Emil Greve**

Emil H. Greve, 65, of Wakefield, died Thursday at the Methodist Memorial Hospital in Omaha.

Services were held Saturday at St. John's Lutheran Church in Wakefield with the Rev. Ronald Holting officiating. Burial was in the Wakefield Cemetery.

Pallbearers were Marilyn Koch, Melvin Wilson, Keith Siebrandt, Don Laese, John Greve Jr. and Henry Greve.

Emil H. Greve, the son of Henry and Martha Hansen Greve, was born Oct. 15, 1913 in Wakefield. On Febr. 6, 1936 at St. Paul's Parsonage in Wakefield, he married Elsie Fenchke. He was a member of St. Paul's Lutheran Church, rural Wakefield.

Greve is survived by his widow, Elsie of Wakefield; three sons, Howard, Arthur and Merlin, all of Wakefield; one daughter, Mrs. Donald (Arlene) Dolph of Wakefield; 16 grandchildren, one brother, John of Wakefield, and four sisters, Mrs. Erwin (Delores) Siebrandt of Wakefield, Mrs. Joe (Alvena) Wilson of Wakefield, Mrs. Bernard (Lena) Koch of Wayne and Mrs. Gus (Mary) Laese of Wisner.

**Verne Harehime**

A former Allen resident, Verne E. Harehime, 79, of Brisbane, Calif., died recently according to an article in the Hardware Merchandiser National Monthly Publication.

The article stated Harehime, chairman of the board, Harehime Corp., Brisbane, Calif., had been in the wholesale hardware business for over 50 years. He had won various awards for his firm's outstanding achievements in the retail as well as wholesale trade, including the Merchandiser of the Year Award in 1976. Harehime is survived by his widow, one son, one daughter, and three grandchildren.

**Kenneth Parke**

Services for Kenneth N. Parke, 80, of Wayne, are scheduled today (Thursday) at 10:30 a.m. at the First United Methodist Church in Wayne with the Rev. Kenneth Edmonds officiating. Burial will be in Greenwood Cemetery in Wayne. He died Monday at Norfolk.

Visitation will be at Wilite Mortuary, Wayne, until time of services.

Honorary pallbearers are Don Wightman, Roy Lange-meier, Hobart Auker, the Rev. Robert Haas, Howard Witte and the Rev. Kenneth Edmonds. Active pallbearers are Robert Merchant, Glenn Walker, Elary Rinehart, Dean Peterson, Jim Hummel, Dale Gushalt, O.K. Brandstetter and Arnold Marr.

Masonic rites were conducted Wednesday evening by Wayne Lodge No. 120 A.F. and A.M. at Wilite Mortuary.

Kenneth N. Parke, the son of Nelson R. and Effie M. Purton-Parke, was born Sept. 21, 1898, in DeKalb County, Ill. He attended elementary school and high school in Kirksland, Ill. He received his college degree from DeKalb Normal; Ph.B. and A.M. from the University of Chicago. He taught in Malta and Fairbury, Ill., and in the Chicago Normal College before joining the faculty of Wayne Normal School in 1924. He resigned in August of 1944. He served in the U.S. Army during WWI.

On June 7, 1924 he married Florence E. Fraser. The couple had two sons, Robert Earl and John Kenneth Parke. Florence died Aug. 25, 1945. He married Marguerite Wells Finch on July 19, 1946.

Kenneth Parke was associated with Northwestern Mutual Insurance for 15 years, beginning in 1944. He was manager of the Wayne Chamber of Commerce from 1956 to 1964 when he retired. He was past commander of the Irwin Sears Post 43 American Legion, past master of Wayne Lodge No. 120 A.F. and A.M., past high priest of Haggal Chapter Royal Arch Masons, past president of N.S.E.A., District III, Silver Beaver Holder, Boy Scouts of America (1937), and past member of Wayne Kiwanis Club, serving as secretary for four years. He received his 50-year pin from the Masonic Lodge and Eastern Star.

He is preceded in death by his parents and one brother. Survivors include his widow, Marguerite of Wayne; two sons, Robert E. Parke of St. Paul, Minn. and John K. Parke of Fremont; six grandchildren; six great grandchildren; six step-grandchildren, nine step great grandchildren; two brothers, Frank Parke of Rockford, Ill. and Melvin Parke of Baley's Harbor, Wisc.; and one sister, Mrs. Doris Gambert of Rockford, Ill.



Steve Schumacher

As children, we tend to take Father for granted. It is only when we became parents that we begin to realize the devoted labor, patience and sacrifice of Father in raising us to be good, useful citizens.

Let us show the depth of our love and appreciation of Dad on this Father's Day.  
 Happy Father's Day.

**HISCOX-SCHUMACHER FUNERAL HOMES**

Wayne 375-3100 Carroll

Mrs. Ed Fork  
585-4827

# CARROLL NEWS

## Presbyterian Women Meet

United Presbyterian Women met at the church June 6 with 12 members and two guests, Mrs. Owen Jenkins of Norfolk, and Roy Jenkins.

Mrs. Enos Williams opened the meeting with a thought for the day. The secretary and treasurer's reports were read by Mrs. Linn Jones and Mrs. Esther Batten.

Mrs. Keith Owens conducted the least coin collection. The group sang "Open My Eyes," accompanied by Mrs. Jones. Mrs. Erwin Morris had the lesson, "Must Be Born Again," and presented a birthday cake commemorating the beginning of Presbyterian churches. Lunch was served by Mrs. Leonard Pritchard.

**Attends Conference**  
Mrs. Robert Johnson attended the annual United Methodist Conference at Lincoln June 8-9 and reported on the meeting during worship services Sunday at the Methodist Church in Carroll.

While attending the conference, Mrs. Johnson was an overnight guest in the Jerry Swihart home.

**St. Paul's Lutheran Church**  
(John Hatermann, pastor)  
Sunday: Worship, 9 a.m.; Sunday school, 9:30.

**Presbyterian-Congregational Church**  
(Gail Axen, pastor)  
Sunday: Bible study, 9:15 a.m.; worship, 10, at the Presbyterian Church.

**United Methodist Church**  
(Janet Baerstein, pastor)  
Sunday: Worship, 9:30 a.m.; Sunday school, 10:30.

**Social Calendar**  
Thursday, June 14: Senior Citizens.

Friday, June 15: Senior Citizens meet for painting at the fire hall.

Monday, June 18: Carroliners Girls 4-H Club, auditorium, 2 p.m.

Wednesday, June 20: Happy Workers Social Club, Mrs. Cliff Rohde; Blue Ribbon Winners, 4-H Club, Dennis Bowers.

Thursday, June 21: Social Neighbors, Mrs. Don Winklebauer.

Mrs. Milton Owens went to Newport last Thursday and brought her mother, Mrs. John Gesirech, home with her to spend a couple of days. Lola and Marilyn Gesirech of Omaha were Saturday guests in the Owens home and took their mother home with them.

Mr. and Mrs. Milton Owens and Megan and Mr. and Mrs. David Owens and Jennifer went to Omaha Sunday to attend the golden wedding anniversary of Mrs. Milton Owens' aunt and uncle, the Earl Dorseys.

Mrs. Delmar Eddie and Valerie went to Coleridge Saturday where they visited Mrs. Eddie's grandmother, Mrs. Alex Stamm, at the Park View Haven Manor.

Duane Johnson, Snoqualmie, Wash., spent June 7-9 in the home of his parents, the Perry Johnsons.

Dr. and Mrs. Orvid Owens and Sue, Lincoln, and Jane Owens, Boston, Mass., spent Saturday in the Owens Owens home.

The Irvan Williams of Carroll and Mary Williams of Lincoln went to Fairmont, Minn. Friday to visit in the Don Bach home to honor Lori Shufeldt's 11th birthday. En route home they visited in the Elmer Wittler home, Spirit Lake, Ia.

Mary Williams of Lincoln came May 31 to visit her grandparents and will also visit a few days in the Harold Wittler and Murray Leicy homes.

Mr. and Mrs. Melvin Jenkins and Elmer Jones went to Columbus Junction, Ia. June 3 and visited until June 7 with Mrs. Jenkins' aunt, Mrs. Maude Peters, who is hospitalized.

"The office makes the man," Latin Proverb

THE WEATHER may have cut down on the activity at the Winside Old Settlers Reunion Saturday, but it didn't stop it as some brave souls took to the rides in drizzle and rain.



Rain or no rain...

THE WEATHER may have cut down on the activity at the Winside Old Settlers Reunion Saturday, but it didn't stop it as some brave souls took to the rides in drizzle and rain.

## DIXON COUNTY COUNTY NEWS

### DIXON COUNTY COURT FINES

Jeff Harfel, Ponca, \$23, exhibition driving.  
Mark A. Clausen, Emerson, \$44, speeding.  
David R. Krause, Ponca, \$233, speeding and driving while intoxicated.  
Robert G. Noe, Allen, \$34, speeding and no valid inspection sticker.  
James R. Kasting, Ponca, \$18, no valid inspection sticker.  
Christopher D. Rooney, Waterbury, \$18, violated stop sign.  
David Pritchard, Concord, \$38, violated stop sign.

### MARRIAGE LICENSES

Mark Stephen Poullosky, 27, and Frances Beth Holtz, 28, both of Ponca.

### REAL ESTATE TRANSFERS

Philip T. and Emma L. Vectors to Sylvester Kneiff, N 1/2 NE 1/4, Sec. 29, and also all that part S 1/2 SE 1/4 of Sec. 20, lying S of Aowa Creek, all in 31 1/2 revenue stamps \$55.00.  
Sylvester and Ellen Kneiff to George H. and Joan Mayer, N 1/2 NE 1/4 of Sec. 29, and also that part S 1/2 SE 1/4 lying S of Aowa Creek in Sec. 20, all in 31 1/2 revenue stamps \$110.00.  
Jerry and Jodene Henschke to Harold E. and Yong Suk Mitchell, lot 11, block 1, Anderson's Addition to City of Wakefield, revenue stamps \$41.80.  
Raymond Stading to Clarence and Gertrude Stading, NW 1/4 31 31N 6, and NE 1/4 NE 1/4 of 36 31N 5, also an undivided 1/2 interest in and to SW 1/4 SE 1/4, 29 31N 6, revenue stamps \$22.00.  
Sylvia Heald to Clarence and Gertrude Stading, NW 1/4 of Sec. 31 31N 6, and NE 1/4 NE 1/4 of 36 31N 5, and an undivided 1/2 interest in and to SW 1/4 SE 1/4, 29 31N 6, revenue stamps \$22.00.  
Clarence and Gertrude Stading to Clarence and Gertrude Stading as joint tenants with right of survivorship and not as tenants in common, NW 1/4, 31 31N 6, and NE 1/4 NE 1/4 of 36 31N 5, and an undivided 1/2 interest in and to SW 1/4 SE 1/4, 29 31N 6, revenue stamps exempt.  
Elsie and Kenneth S. Watchorn as joint tenants with right of survivorship, S 1/2 SE 1/4 and NW 1/4 SE 1/4, 29 31N 6, revenue stamps exempt.  
Clarence and Gertrude Stading to Raymond Stading, W 1/2 SW 1/4 of Sec. 30 and E 1/2 SW 1/4, all in 31N 6, and also an undivided 1/2 interest in and to SW 1/4 SE 1/4.

### MOTOR VEHICLE REGISTRATION

1978 — Gene A. Vraspor, Emerson, Fd Bronco, Louis N. Sæum, Waterbury, Vm; Joyce M. Persinger, Ponca, Fd; Tom McKaughton, Allen, Vm; Robert E. Grosvenor, Newcastle, Fd Pkp; Roger Davis, Ponca, Kaw, D; Thomas Curry, Newcastle, Gop; Dennis Meyer, Wakefield, Chev Pkp; Darrel E. Magnuson, Emerson, Fd Pkp; Kandace L. Rahn, Allen, Fd; Tim L. Lueth, Emerson, Fd Pkp.  
1978 — George Watchorn, Ponca, Kaw; Emmet Amussen, Ponca, Fd Pkp; Leonard Zerbe, Newcastle, Chev; Zona Krause, Ponca, Fd; Sam's Sales and Rentals, Ponca, Cruise; Master Mini Home, Per Pearson, Wakefield, Fd.  
1977 — Carla Johnson, Wakefield, Pkp.  
1976 — Alan Giltner, Emerson, Fd Pkp; O N Knerl and Sons, Ponca, Fd.  
1975 — Ted J. or James McDonald, Allen, Chev; John F. Kingsbury, Ponca, Chev.  
1974 — Larry O. Damm, Emerson, Fd Pkp; John F. Kingsbury, Ponca, Honda; Lucia E. March, Allen, Fd Van; Dale W. Maggart, Waterbury, Fd; William C. Chase, Allen, Fd; Darlene A. Benton, Allen, Fd; Harold E. Stark, Newcastle, AMC; Stanley Steele, Emerson, Buick.  
1972 — William C. Chase, Allen, Fd; Martha Smith, Allen, Fd; Candace Stama, Wakefield, Chev; Duane H. Curry, Newcastle, Chev; Dick Harrison, Ponca, Fd.  
1972 — Curtis J. Saunders, Dixon, Pky; Gary Whetzel, Newcastle, Fd; Gilbert L. Frey, Emerson, Ddg Sweetline Express; Linda L. Carl son, Ponca, Pont Station Wagon; Kent L. Grosvenor, Ponca, Chev.  
1971 — Robert L. Anderson, Concord, Fd Pkp; Paul D. Burmann, Allen, Mack Tractor.  
1970 — James E. Hinds, Ponca, Route Alum Travel Trailer.  
1969 — Jim Saunders, Dixon, Chev Pkp; Tammy McKeever, Emerson, Merc; Donald D. Curry, Ponca, Chev.  
1968 — John W. Roche, Newcastle, Cad; John W. Adink, Wakefield, Chev; Sam's Sales and Rentals, Ponca, Travel Craft Travel Trailer; James D. Cutting, Allen, Ramb Rebel Station Wagon; Earl C. Nelson, Concord, Chev Suburban.  
1967 — Mary Lou Smith, Allen, Merc.  
1965 — Brian Rees, Concord, Chev.  
1964 — Charles A. Nelson, Concord, Pky.  
1962 — Mabel Amson or Harold Nicolis, Allen, Chev Trk; Mabel R. Amson, Allen, Chev.  
1948 — John Schwers, Ponca, Chev Station Wagon.  
1946 — Arland Wurdeman, Wakefield, Olds.

**PAMIDA**  
DISCOUNT CENTER  
Prices Effective  
Wednesday, June 13 Thru  
Sunday, June 17

**FATHER'S DAY SALE**

**24" BARBECUE GRILL**  
No. 2407  
Reg. \$10<sup>96</sup>  
**\$8<sup>88</sup>**

**WEBBED LAWN CHAIR**  
**2/\$10** Reg. \$9<sup>96</sup>  
**WEBBED CHAIR LOUNGER**  
Reg. \$14<sup>96</sup>  
**\$10<sup>00</sup>**

**Turco Propane GAS GRILL**  
Reg. \$119<sup>97</sup>  
**\$99<sup>96</sup>**

**75% OFF**  
All Action SOCKETS & RATCHETS  
(While Quantites Last)

**Taylor 7.96** SAVE 4.01  
Reg. 11.97 Taylor 12 in. patio thermometer in white molded rugged case. It's rust-proof and will complement your outdoor decor. Fahrenheit and Celsius scale.

Old Spice 2.5 Oz. <b>STICK DEODORANT</b> <b>96¢</b>	Remington Trap & Skeet <b>TARGETS</b> 135 Ct. Chrome Yellow <b>\$346</b> Reg. \$3 <sup>97</sup>	Home-E-Quip Steel Work <b>BENCH LEGS</b> <b>\$11<sup>88</sup></b> Reg. \$15 <sup>96</sup>	Bernzo O Matic Maxi Propane <b>JET TORCH KIT</b> <b>\$8<sup>88</sup></b> Reg. \$12 <sup>97</sup>	21 Pc. Ratchet <b>SOCKET SET</b> 1/4 & 3/8" Combination <b>\$7<sup>88</sup></b> Reg. \$9 <sup>97</sup>
Normark Big Swede Folding <b>HUNTING KNIFE</b> <b>\$7<sup>88</sup></b> Reg. \$9 <sup>96</sup>	Ray-O-Vac Sportsman Fluorescent <b>LANTERN</b> <b>\$28<sup>88</sup></b> Reg. \$33 <sup>95</sup>	Black & Decker Jack Rabbit <b>PUMP &amp; SPRAYER</b> <b>\$10<sup>96</sup></b> Reg. \$12 <sup>97</sup>	Q Beam Super <b>SPOT LIGHT</b> Fits Any Standard Cigarette Lighter Receptacle <b>\$14<sup>96</sup></b> Reg. \$17 <sup>97</sup>	Blue Ice <b>COOLER</b> Needs no ice just freeze lid <b>\$3<sup>27</sup></b> Reg. \$3 <sup>97</sup>
Wilson Prostaff X-Out <b>GOLF BALLS</b> Pkg. of 3 balls <b>\$1<sup>46</sup></b> Reg. \$1 <sup>99</sup>	Polyethylene <b>GOLF TUBES</b> <b>5/\$1<sup>00</sup></b> Reg. \$2 <sup>7</sup>	HANG-A-TOOL Tool Storage Rack for Garage, Basement, Kitchen and more <b>\$3<sup>96</sup></b> Reg. \$4 <sup>97</sup>	Kodiak 6' <b>GRAPHITE/GLASS ROD</b> <b>\$19<sup>97</sup></b> Reg. \$24 <sup>97</sup>	Johnson Sprite 200A <b>SPIN CAST REEL</b> <b>\$10<sup>97</sup></b> Reg. \$14 <sup>97</sup>

**WAYNE MUNICIPAL AIRPORT**  
ALLEN ROBINSON  
East Hwy. 35 Ph. 375-4444

**\$10 CASH REBATE**  
on this Regency 10 Channel, No Crystal Police Radio Scanner  
Normal Price \$229.95  
Less Rebate -10  
Net Price To You \$219.95  
Regency  
SHERRY BROS.  
HOME & HOME CENTER  
Phone 375-2022

# IT'S EASY TO BUY-SELL-RENT-HIRE & FIND WITH WANT ADS

**For Rent**  
**APARTMENT** for rent, call Glenn L. Wiseman, 375-1918. [111F]



**HOMES FOR SALE**  
 2,000 square feet of living space in this attractive central air conditioned, fully carpeted, 1/2 year old home. Spacious living room, large kitchen-family room combination with an energy-saving forced air heater/wood-burning fireplace, 3 bedrooms, 3 baths plus a 20 x 24' carpeted recreation room, 2 car garage — chain link, fenced-in back yard with a large concrete patio with privacy fence. Excellent location. Call and make an appointment.



Solid older home, close in to downtown, living room, kitchen, den, 3 bedrooms and 2 baths, modest price.



Three bedroom central air conditioned home, carpeted living room, dining room, kitchen, 3 bedrooms and bath, full basement, close to the college — priced for quick sale.

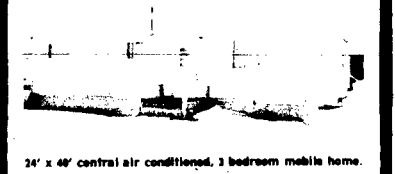

24' x 46' central air conditioned, 3 bedroom mobile home.



Spacious 3-4 bedroom central air conditioned, newly carpeted, fully insulated home featuring: Granite fireplace setting off the living room — Dining room — Large kitchen-family room with built in dishwasher, cook top with grill, double oven, lots of birch cupboards — spacious bedrooms with large closets — 2 1/2 baths — Beautiful recreation room and wet bar — Enclosed breezeway — Large covered patio — Attached 2 car garage with electric garage door opener — Stone veneer — Chain link fence. Ideal family home — look today.



721 Windom  
 FOR THESE AND OTHER FINE HOMES.

**PROPERTY EXCHANGE**  
 112 Professional Building Phone 375-2134  
 Wayne, Nebr.

**FOR RENT:** Newly carpeted two bedroom home near shopping area. Nice yard and small garage. Available June 15. Write Wayne Herald, Box HFR, Wayne, Ne. [17H]

**FOR RENT:** One bedroom basement apartment, furnished. Call after 5 p.m. 375-1969. [143F]

**FOR RENT:** One bedroom apartment. Efficiency apartments. Rooms by the week or month. Call 375-2252. [m29FF]

**FOR RENT:** Nice one bedroom basement apartment, utilities paid, central air conditioning. Available after June 17. Phone 375-2726. [143F]

**Automobiles**  
 74' NOVA, 350, 4 speed, track lion bars, air shocks, cragers, AM FM stereo, near new tires, good car. Call 286-4818. a21F

**WANT TO RENT-A-CAR?**  
 See Us FIRST!  
**ARNIE'S**  
 Open Evenings

**Business Opp.**  
 BUSINESS expanding. If interested in second income, write Box 26, Wayne, Ne. 68787. [14]

**Real Estate**  
 FOR SALE: Properties located at 407 Walnut and 410 Walnut, Wayne. Contact Trust Department. The State National Bank and Trust Co. 375-1130. [m21FF]

## Help Wanted

**MILTON G. WALDBAUM:**  
 We are now taking applications for night shift.  
 If interested apply at front office.

HELP WANTED: Must be 18 or older. Casey Roofing Co., Laurel. [a21F]

**WAYNE STATE COLLEGE**  
 VACANCY NOTICE  
 CUSTODIAN II: Performs general custodial duties such as sweeping, scrubbing, waxing, dusting, cleaning lavatories, washing windows, collecting refuse, etc. Will use the usual custodial machines. Rotating shifts. QUALIFICATIONS: Minimum knowledge of custodial work, ability to perform from oral and written instructions, and the physical ability to handle routine custodial duties. SALARY: \$347 per month plus benefits. STARTING DATE: July 1, 1979. APPLICATION PROCEDURE: Submit letter of application and completed application form to Mr. Earl Larson, Director of Physical Plant, Wayne State College, Wayne, NE 68787 by June 25, 1979.  
 THIS COLLEGE IS AN EQUAL EMPLOYMENT OPPORTUNITY EMPLOYER.

**DEMONSTRATORS**  
 MERRI-MAC enables you to earn cash on your own hours. Our guaranteed line of toys and gifts plus super hostess incentives make this party plan program unbeatable.  
 No Investment, Delivery or Collection  
 Call Collect to Ann Baxter 319-556-8881  
 Or Write MERRI-MAC, 801 Jackson, Dubuque, Iowa 52001

## WE HAVE...

- SIDING
- INSULATION
- SEAMLESS ALUMINUM GUTTERING (Colors Available)
- CHAIN LINK FENCE (With or Without Installation)

IT DOESN'T COST ANYTHING FOR A COMPETITIVE BID

**PHATT, WAEKER**  
 home improvement  
 Lynn Gunderson  
 Wayne, Ne. 375-1429  
 301 N. 4th St. Box 136 Norfolk, NE 68701  
 Or Call Collect Anytime 102-371-1676  
 "We're Here To Do Business"

**THE BROYHILL MFG. CO. OF WAYNE WILL BE ADDING NITE 3:30-11:30 p.m. AND PERMANENT EMPLOYEES**  
 For Mig Operation Open To Trainees or Experienced Personnel \$3.30 \$4.00 per hr.  
 Apply At: Job Service, Wayne 375-2945 or, Broyhill Mfg. Plant at Wayne 375-4818 or, EMCO, Wayne 375-3050

**HELP WANTED:** Temporary help for fertilizer season. Apply at Tri County Coop Fertilizer, Laurel. Call 256-3295. [m29FF]

**FOR RENT:** Air conditioned two bedroom apartment, stove and refrigerator furnished. No pets, adults only. Phone 375-1885. [m71F]

**TOP EARNINGS**  
 We need assistance in evaluating short stories submitted by amateur authors throughout the state. No experience necessary. Free training provided at home, salary \$4.87 per hr. work at home. For complete information send printed name and address to:  
 Associated Writers Guild, Inc. P.O. Box 71, Wayne, NE 68787.

**WAYNE STATE COLLEGE**  
 VACANCY NOTICE  
 CUSTODIAN II: Performs general custodial duties such as sweeping, scrubbing, waxing, dusting, cleaning lavatories, washing windows, collecting refuse, etc. Will use the usual custodial machines. Rotating shifts. QUALIFICATIONS: Minimum knowledge of custodial work, ability to perform from oral and written instructions, and the physical ability to handle routine custodial duties. SALARY: \$347 per month plus benefits. STARTING DATE: July 1, 1979. APPLICATION PROCEDURE: Submit letter of application and completed application form to Mr. Earl Larson, Director of Physical Plant, Wayne State College, Wayne, NE 68787 by June 25, 1979.  
 THIS COLLEGE IS AN EQUAL EMPLOYMENT OPPORTUNITY EMPLOYER.

**PROGRESSIVE AGRICULTURAL** Supplier has established many shifts available for Scotty's Restaurant. Also janitor service needed 7 days a week 2 hours daily, on salary. Apply at Nebraska Job Service Office, 108 West 3rd St., Wayne, Ne. [m31FF]

**HELP WANTED:** Mechanic experience preferred. Excellent opportunity in a young organization. Full benefits. Chrysler Center, 375-3270. [a23]

**SEE Coast to Coast** in downtown Wayne for all your lawn and garden needs. We handle a complete line of mowers, tillers and Earl May garden seeds. [m211F]

**LOST** women Wilson softball glove Reward Call 375-3393. [14]

**FATHER'S DAY GIFT IDEAS!**  
 — Fishing Tackle.  
 — Chaise Lounges & Lawn Chairs.  
 — Tools.  
 — Auto Accessories.  
 — Lawn Mowers.  
 — Garden Equipment.  
 — BBQ Grills.  
 — Keep Dad Busy With A Gift From  
**COAST TO COAST**  
 217 Main Wayne

**THANK YOU:** A sincere thank you to the staff at Providence Medical Center and to Dr. Wiseman and all who gave their help and showed their concern with flowers and calls after the accident. John Dall. [14]



**Making the Trip West**

**DAYS OUT** of the pioneer west were illustrated during the parade Sunday at the Winside Old Settlers Reunion. The float (at right) was fashioned by the Scattered Neighbors Extension Club heading west in a covered wagon (above) are Mrs. John Hafermann and Marcelle and Edward (in the wagon). The parade was postponed from Saturday because of the weather.

## LESLIE NEWS / Mrs. Louie Hansen 287-2346

### Three Birthdays Honored

Raymond Brudigam observed his birthday Sunday evening when guests in the Brudigam home were the Ed Krusemarks, the Ronnie Krusemarks, the Merle Krusemarks, the Lonnie Nixons, Laurel Arnold Brudigam and the Marvin Stollies. Guests in the Jerry Anderson home June 7 to celebrated Gary Anderson's ninth birthday, were the Larry Andersons, the Alvern Andersons, the Carl Andersons and the Erwin Bergers. Lori Anderson also observed her birthday Saturday evening guests were the Dave Andersons.

### Special Notice

**League Outing**  
 St. John's Waiher League's outing at Ponca State Park was held Sunday with new confirmands as guests. Parents of the Leaguers joined them at 6 p.m. for a potluck supper.

**MOVING?**  
 Don't take chances with your valuable belongings. Move with Aero Mayflower, America's most recommended mover.

**Abler Transfer, Inc.**  
 WATCH for pillow cleaning sponsored by V.F.W. Auxiliary of Wayne, at 213 East 3rd, Friday, June 22. [14]

### Card of Thanks

**THANK YOU:** Thank you to everyone who called, sent flowers, wrote letters, brought food and came to visit while I was in the hospital in Sioux City and while I was in Oklahoma. A special thanks to all the prayer groups, the Rev. Edmonds and to Sue, Dean and Erma for helping here at home. God bless you all. Norma Roland. [14]

**THANK YOU:** A sincere thank you to the staff at Providence Medical Center and to Dr. Wiseman and all who gave their help and showed their concern with flowers and calls after the accident. John Dall. [14]

**Fish & Chicken**  
 Friday, June 15  
**RON'S BAR**  
 Carroll, Nebraska  
 NEW! Mini Salad Bar on Week-ends except Fish Fry Fridays!

**Salute—**  
(Continued from page 1)

Special music will be provided by the Trable Ciel Singers of the First United Methodist Church in Wayne, comprised of Mary Edmond, Norma Ehlers, Sandy Anderson, Cindy Nigh, Geraldine Lipp, Nancy Fugelberg, Becky Wilson, Nancy Keldel, Donna Liske, Kay Marsh and Marty Anderson.

The group, which is accompanied by Yvonne Morris, will sing a selection of "garden songs" to go along with the luncheon theme.

In addition to the free meal and program, door prizes will be given.

In past years, an Outstanding Farm Woman has been recognized for her contributions to her home, church and community. Nominations were sent prior to the luncheon and judging was based on the nominee's good neighbor activities.

Chairman Mrs. Sheryl Marra said this year's committee has decided to recognize all farm women instead of singling out one woman to receive the honor.

"It's nearly impossible to decide what it is that makes one woman deserve the award more than another," said Mrs. Marra, adding that farm women have many diversified talents, whether it be driving a grain truck, caring for livestock, teaching Sunday school, assisting with 4-H projects, or lobbying in Washington as guest speaker Mrs. Betty Majors.

Working with Mrs. Marra to plan this year's event is Rozan Pederson. Other members of the committee are Anita Fugelberg, Sandra Elliott, Jackie Dilman, Jan Brown, Phyllis Leach, Claudia Krow, Jennifer Carney, Donna Ewing, Cindy Nigh and Debbie Rise.

**Increase—**  
(Continued from page 1)

water used in the city during the school year, and 24 percent throughout the entire year.

He said the college has had a beneficial water rate and has been paying between \$10,000 and \$11,000 a year. "They will now pay in the neighborhood of \$21,000 per year with the new rates."

The engineer said the rates were determined on a fair and equitable basis and are established to be apportioned to water usage.

**Putter—**  
(Continued from page 1)

the hole-in-one to win those valuable gift certificates.

The Retail Committee of the Wayne Chamber is in charge of the contest with Chuck Barnes, chairman of the event.

**Carroll—**  
(Continued from page 1)

Plasma class 10 to 12 years: Pam Huntley, Norfolk; Curt Nelson, Carroll; Yvette Krueger, Norfolk and Bobbi Huntley, Norfolk.

Potato Race nine years and under: Bobbi Ditttrick, Meadow Grove; Jan Hansen, Stanton; Jan Balzer, Howells and Cory Nelson, Carroll.

Potato Race 10 to 12 years: Mike Behmer, Hoskins; Curt Nelson, Carroll; Pam Huntley, Norfolk and Noelle Johnson, Madison.

Musical Tires 9 and under: Cory Nelson, Carroll; Gene Daniel, Stanton; Jan Hansen, Stanton and Dana Nelson, Carroll.

Musical tires 10 to 12 years: Curt Nelson, Carroll; Robby Huntley, Norfolk; Pam Huntley, Norfolk and John Kabeiseman, Yankton.

Barrel Crawl 12 years and under: Jan Hansen, Stanton; John Kabeiseman, Yankton; Cory Nelson, Carroll and Bobbi Ditttrick, Meadow Grove.

Circular Baton: Mark Flier team, Hoskins; Shelly Davis team, Carroll; Jana Jenkins team, Carroll and Gloria Balzer team, Howells.

Run-ride and lead: Scott Mann, Hoskins; Shelly Davis, Carroll; Doug Jenkins, Carroll and Rod Nelson, Ainsworth.

Rat Race: Dave Asmus, Hoskins; Bill Langenberg, Hoskins; Gloria Balzer, Howells and Brian Kreikemeier, West Point.

Key Hole Race: Belinda Cooper, Ainsworth; Shelly Davis, Carroll and Tim Rohde, Fremont.

Officers of the local club are Kevin Davis, president; LeRoy Nelson, vice president; Mrs. Ronald Kiffle, secretary and Mrs. Steve Schumacher, treasurer.

Barrell Race 10-12 years: Cory Nelson, Carroll; Bobbi Ditttrick, Meadow Grove; Mike Behmer, Hoskins and John Kabeiseman, Yankton.

Pole Bending 10-12 years: Curt Nelson, Carroll; Bobbi Ditttrick,

Meadow Grove; Tammy Gahill, Dakota City and Kevin Vering, Howells.

Stake Race 10-12 years: Cory Nelson, Carroll; John Kabeiseman, Yankton; Curt Nelson, Carroll and Mike Behmer, Hoskins.

Stake race 9 years and under: Bobbi Ditttrick, Meadow Grove; Jan Balzer, Howells; Jon Hansen, Stanton and Toby Smith, Norfolk.

Boof race winners were: Kelli Davis, Carroll; Dana Nelson, Carroll; Bobbi Ditttrick, Meadow Grove; Deanna Daniel, Stanton; Russ Vering, Howells; Kristy Hansen, Stanton; Kary Vering, Howells and Jenny Asmus, Hoskins.

The yearlings at halter class winners were: Marti Lange, Hoskins; Arlin Salling, Norfolk; Richard Scott, Norfolk and Lyle Cunningham, Carroll.

Two year old mares at halter: Patty Farner, Norfolk; D'Ann Hagberg, Spencer; Rick Erwin, Laurel and John Paul, Elgin.

Two year old geldings at halter: Yvette Krueger, Norfolk; Richard Scott, Norfolk; Ione Devoll, Bassett.

Three year old mares at halter: Virginia Ditttrick, Meadow Grove; Sherri Triggs, Wayne and Shelly Davis, Carroll.

Three year old geldings at halter: Virginia Ditttrick, Meadow Grove; Shelly Davis, Carroll; Richard Scott, Norfolk and Julie Paul, Elgin.

Junior Western Pleasure: Jenny Adams, Norfolk; JoAnn Whealy, Norfolk; Wes Hermalbrach, Rosalie; and Cheryl Smith, Norfolk.

Ladies Western Pleasure: Marti Lange, Hoskins; Shelly Davis, Carroll; Sherri Triggs, Wayne and Deb Brummond, Wayne.

Mens Western Pleasure: Rod Nelson, Ainsworth; Kevin Davis, Carroll; Don Cunningham, Dixon and Roger Langenberg, Hoskins.

Junior Hat Race: Jeff Behmer, Hoskins; Dwayne Asmus, Hoskins; Larry Renter, Snyder and Kim Balzer, Howells.

Senior Hat Race: Shelly Davis, Carroll; Dave Asmus, Hoskins; Becky Cooper, Alcester, S.D. and Ross Rohde, Fremont.

Horse shoe pair: Ross Rohde, Fremont; Dave Asmus, Hoskins; Rod Nelson, Ainsworth and Wes Balzer, Howells.

Junior Barrels: Kim Balzer, Howells; Larry Renter, Snyder; Wes Balzer, Howells and Dwayne Asmus, Hoskins.

READ AND USE WAYNE HERALD WANT ADS

Senior Barrels: Dawn Phillips, Meadow Grove; Rod Nelson, Ainsworth; Shelly Davis, Carroll and Dave Asmus, Hoskins.

Junior Barrels: Jeff Behmer, Hoskins; Kim Balzer, Howells; Curt Nelson, Carroll and Peg Cahill, Dakota City.

Senior Poles: Dave Asmus, Hoskins; Debbie Woodford, Ponca; Tim Rohde, Fremont and Bill Langenberg, Hoskins.

Four in a line, junior: Kim Balzer team of Howells won first place and Joe Hansen team of Stanton, second place.

Four in a line, senior: Ross Rohde, Fremont; Becky Cooper, Alcester, S.D.; Rhonda Vering, Howells and Gloria Balzer, Howells.

Ladies Egg and Spoon: Becky Cooper, Alcester, S.D.; Carolyn Hansen, Jackson; Shelly Davis, Carroll and Kim Balzer, Howells.

Western Reining: Roger Langenberg, Hoskins; Rod Nelson, Ainsworth; Kevin Daniels, Stanton and Joann Devoll, Bassett.

Flag Race: Shelly Davis team, Carroll; Mark Flier team, Hoskins; Rhonda Vering team, Howells; Becky Cooper team, Alcester, S.D.

Serpentine Race: Gloria Balzer, Howells; Shelly Davis, Carroll; Rhonda Vering, Howells and Becky Cooper, Alcester, S.D.

Innertube Race: Mark Flier, Hoskins; Jana Jenkins, Carroll; Shelly Davis, Carroll and Rhonda Vering, Howells.

**The Weather**

Things Warming Up



**Winside Band Plays Concert**  
THE WINSIDE High School lended to festive activities at the Winside Old Settlers Reunion Sunday with a concert in the park. The band is under the direction of Vince Boudreau.

**LAUREL NEWS** / Mrs Sandra Hoffart 256-3563

Date	Hi	Lo	Precip.
June 6	91	68	
June 7	80	62	
June 8	60	47	.52
June 9	56	48	
June 10	76	46	
June 11	84	NA	
June 12	94	61	

**Social Calendar**  
Monday, June 18: Magic Finders A.H. Club; Jim Lipp home swimming lessons begin.  
Tuesday, June 19: Ladies golf league; Crusaders, Creative Crafts.  
Wednesday, June 20: Ladies tennis league; mens golf league.

**United Lutheran Church** (Kenneth Marquardt, pastor)  
Sunday: Worship, 8 a.m.  
Sunday school, 9:15  
Tuesday: Ladies Bible study 9:30 a.m.; Couples Bible study, 7:30 p.m.  
Wednesday: Prophecy Bible study, 8 p.m.

**United Methodist Church** (James Mate, pastor)  
Thursday, Flag Day  
Sunday: Sunday school, 9:30 a.m.; worship, 10:45 a.m.  
Tuesday: Crusaders, 8 p.m.  
Wednesday: Bible study, 9:30 a.m.; United Methodist Women, 2 p.m.

**World Missionary Fellowship Church** (Jens Kvoll, pastor)  
Thursday: Ladies Bible study 9:30 a.m.  
Sunday: Sunday school, 10 a.m.; worship, 11 Youth Fellowship 7 p.m.; evening worship, 8 p.m.  
Wednesday: Bible study 8 p.m.

**United Presbyterian Church** (Thomas Robson, pastor)  
Sunday: Sunday school, 9 a.m.

**Tour Black Hills**  
Two Wayne Girl Scouts have just returned from a trip to the Black Hills in South Dakota. Dori Aitvin and Michelle Doring are members of the local Girl Scout organization which is part of the Prairie Hills Girl Scout Council.

**St. Mary's Catholic Church** (Jerome Spenner, pastor)  
Saturday: Mass, 7:45 p.m.  
Sunday: Mass, 8 a.m.  
Tuesday: Mass, 7 p.m.; Inquirers Class at rectory, 7:30

**Flags Fly Thursday**  
The Wayne Chamber of Commerce have flags flying today (Thursday) in honor of Flag Day and in honor of the late Kenneth Parke, 80, whose funeral was today. Parke was a former Chamber of Commerce manager and Wayne civic leader.

**News Briefs—**

**Attend Store Meeting**  
Mel and Ruth Eloffson, owners of the Coast to Coast Store in Wayne, attended a merchandise meeting held June 3 to 4 in St. Paul, Minn. The meeting featured fall, winter and Christmas merchandise and programs.

**Chamber Coffee Friday**  
Gail Korn, representative for Marshall Nurseries, will host the Wayne Chamber of Commerce Coffee Friday from 10 to 11 a.m. The nursery is located three and one-half miles south of Wayne on Highway 15. There will be innovative ideas of landscaping and use of shrubbery. All Chamber members are urged to attend.

**State-National Farm Management Co.**  
Real Estate Sales and Loans  
Henry L. REALTORS Felix Dorcay

John Dorcay, Alex Liske, Susan Wisser, Ewen Brandenburg — Wayne

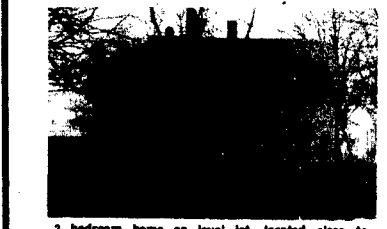

2 bedroom home on level lot, located close to shopping. Garage and large storage building.



2 bedroom home on 75 x 150 lot. Located close to college. Full basement. Fireplace. Detached garage.



Two bedrooms up and two bedrooms down in this 8-year old home. Stove, dishwasher, garbage disposal and water softener included. Deck with gas grill. Two-car attached garage with automatic door opener. Central air. Located in Westwood Addition.



3 Bedroom 14' x 75' Mobile Home. Includes outside storage shed, stove, refrigerator, washer, dryer, curtains, drapes and carpeting.



618 Logan



3 bedroom home located close in. Excellent condition with new carpet. Price in low 20's.



1/2 Acre Lot For Sale

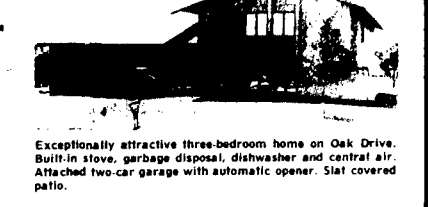

Exceptionally attractive three-bedroom home on Oak Drive. Built-in stove, garbage disposal, dishwasher and central air. Attached two-car garage with automatic opener. Slat covered patio.

**IF YOU ARE MOVING FROM THE WAYNE AREA CONSIDER THESE FACTS ABOUT A SERVICE WE PROVIDE**  
RELO/Inter-City Relocation Service was founded in 1960 as the nation's first not-for-profit broker-owned and broker-directed real estate referral service.  
RELO has been the world's leading relocation service for consumers and the leading referral service for real estate professionals for nearly a decade.  
RELO is a not-for-profit organization providing a referral network, and marketing and educational program support.  
Because of RELO's member-owned, not-for-profit structure, service is the primary consideration.  
RELO services include:  
a meeting with the originating broker, who will offer help that includes appraisal and marketing of the family's present home.  
services in finding the right home, including help in comparing buildings, viewing companies and other developments.  
All RELO services are provided at no additional cost or

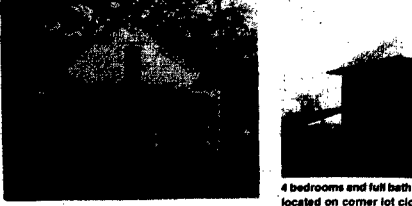

2 bedroom home located close to downtown on 50' x 75' lot. Commercial zoning.



4 bedrooms and full bath upstairs in this 2-story home located on corner lot close to college. Priced in low 30's.



416 E. 5th



Two bedroom house on 75x150 lot. Located close to schools. Full basement and detached garage.

**BUSINESS-FOR-SALE**  
Excellent small business for sale in Wayne. Real Estate included.



221 Oak Drive

**FOR SALE**  
Wayne County Farm, 60 Acres.

**ACREAGE**  
Located between Emerson and Wakefield. Two bedroom home with a modern furnace and excellent well.

Support The Real Estate Office Displaying This Emblem  
The Real Professional In The Real Estate Business  
Member Local, State & National Real Estate Associations

**STILES CO.**  
SOLD  
126 S. Main, Wayne

RED HOT PATIO DEALS, THIS IS NO SMOKE — RED HOT PATIO DEALS, THIS IS NO SMOKE — RED HOT PATIO DEALS, THIS IS NO SMOKE — RED HOT PATIO DEALS, THIS IS NO SMOKE — RED HOT PATIO DEALS, THIS IS NO SMOKE

COME JOIN THE FUN!!

# Patio Sale

When the smoke clears, you'll find the Best Deals on New and Used Cars in Northeast Nebraska!

FREE BAG OF CHARCOAL  
With Every Demonstration Drive In A New Or Used Car During Our Sale. (Limit 1 Per Family)

FREE BAG OF CHARCOAL  
With Every Demonstration Drive In A New Or Used Car During Our Sale. (Limit 1 Per Family)

FREE

**Barbecue Sandwiches**  
**THURSDAY - FRIDAY - SATURDAY**  
All Day — June 14, 15 and 16

FREE Look What You Get When You Buy a New or Used Car During Our Sale

ABSOLUTELY FREE



YOUR CHOICE OF A

- ★ Chaise Lounge & Chair
- ★ Coleman Cooler ★ Hammock

All outdoor merchandise from Pamida Gibson in Wayne. See something else you like, you can purchase it at Gibson's in Wayne.



OUR DEALS ARE RED HOT!

FREE PORTABLE GAS GRILL

Stop Out and Register for FREE PORTABLE GAS GRILL WITH TANK

(Drawing to be held Saturday, June 16)

## Demonstrators and Driver Trainers

1979 Monte Carlo Coupe (C-4)  
267 V-8, automatic, power steering, power brakes, air conditioning, deluxe body side moldings, remote control mirror, tilt wheel, white radial tires, radio.  
\$5,750

1979 Malibu (C-6)  
4 door, 267 V-8, power steering, power brakes, deluxe body side moldings, wheel opening moldings, remote control mirror, full wheel covers, white tires, radio.  
\$4,990

1979 Olds Cutlass Salon (O-6)  
4 door, 260 V-8, power steering, power brakes, air conditioning, accent moldings, tilt wheel, white tires, radio.  
\$5,490

1979 Cutlass Supreme Brougham Wagon (O-14)  
260 V-8, power steering, power brakes, air conditioning, deluxe belts, tinted glass, floor mats, remote control mirror, cruise control, tilt wheel, super stock III wheels, white tires, AM-FM radio, auxiliary lighting, divided seat, lower body moulding, roof carrier, wood grain.  
\$6,650

1979 Chevrolet 1/2-Ton (T-5)  
350 V-8, power steering, power brakes, air conditioning, Scottsdale, heavy duty front springs, tinted glass, radio, upper and lower chrome moldings, heavy duty rear springs, gauges, wheel covers, big 10 deluxe tu-tone in camel and tan.  
\$5,950

## No Smoke Used Car Specials

1978 Olds Omega  
2 door, V-6 engine, automatic, power steering, power brakes, air conditioning, tilt wheel, white tires, a real gas saver. Was \$4,595.  
Now \$3,995

1977 Chevrolet Caprice  
4 door, 350 V-8, power steering, power brakes, air conditioning, cruise control, tilt wheel, top of the Chevrolet line. Was \$4,895.  
Now \$4,295

1977 Monte Carlo  
power steering, power brakes, air conditioning, cruise control, tilt wheel, AM-FM radio, rally wheels, and more. Last year for the full size Monte. Was \$4,995.  
Now \$4,495

1977 Mercury Grand Marquis  
4 door, this car has all the goodies, new radial tires, local one owner, low miles. Was \$5,995.  
Now \$5,595

1976 Ford Elite  
power steering, power brakes, cruise control, tilt wheel, local owner, low miles, bright red with a white vinyl top, super nice. Was \$4,595.  
Now \$3,995

1976 Ford LTD Coupe  
V-8, automatic, power steering, power brakes, air conditioning, cruise control, tilt wheel, AM-FM stereo, a steal. Was \$3,995.  
Now \$3,395

1976 Pontiac Gran Prix  
Lots of class here, T-top and all. An excellent buy. Was \$4,695.  
Now \$3,995

1974 Olds Delta Royale Coupe  
350 V-8, automatic, power steering, power brakes, air conditioning, tilt wheel, new radials. Was \$1,695.  
Now \$1,395

1972 Chrysler New Port  
4 door, the car is right, the miles are right, the price is really right. Was \$1,095.  
Now \$695

1972 Ford 1/2-Ton 4 Wheel Drive  
V-8, 4 speed, 57,000 miles, this has to be one of the nicer '72's around.  
\$1,995

1971 Ford LTD  
4 door, good old second car, better than you may think.  
\$295

1970 Buick LaSabre  
Local car, lots of work car miles left.  
\$295

1978 Ford 3/4-Ton  
V-8, automatic, power steering, power brakes, air conditioning, new tires, side moldings, tu-tone in blue and white. Was \$5,595.  
Now \$4,795

1978 Luv Pickup  
Automatic transmission, radio, best bumper, low miles, lots of economy, fiberglass topper. Was \$4,295.  
Now \$3,795

1977 Suburban 4 Wheel Drive Silverado  
Front and rear air, new radial tires, 3 seats, wood grain paneling, 400 V-8. Was \$8,295.  
Now \$7,895

1976 GMC 1/2-Ton 4 Wheel Drive  
400 V-8, automatic, power steering, power brakes, air conditioning, local one owner. Was \$5,495.  
Now \$4,995

1974 Ford Van  
6 cylinder, automatic, power steering, 49,000 miles, extra nice—see this one. Was \$2,995.  
Now \$2,595

1973 Chevrolet 3/4-Ton  
350 V-8, automatic, power steering, power brakes, good runner, a real work horse. Was \$2,295.  
Now \$1,895

1972 Ford 1/2-Ton  
V-8, automatic, power steering, power brakes, air conditioning, 58,000 miles, red in color, test drive this one. Was \$1,995.  
Now \$1,595

1977 Olds Cutlass Supreme Coupe  
350 V-8, automatic, tilt wheel, air conditioning, super stock wheels, yellow with a white vinyl top, white vinyl interior, super nice. Was \$5,295.  
Now \$4,895

- NEW CARS IN STOCK — ★ 1 - Corvette ★ 13 - Caprices ★ 6 - Impala's ★ 5 - Monte Carlo's  
★ 6 - Chevelle's ★ 2 - Citation's ★ 1 - Chevette ★ 6 - Chevy & Olds Wagons ★ 2 - 70 Series  
★ 8 - Cutlass's ★ 1 - Cutlass Wagon, Diesel ★ 2 - Holiday Coupe's ★ 10 - Royale's  
★ 5 - Regency ★ 3 - Toronado's ★ 17 - 1/2-Ton's ★ 2 - 3/4-Ton's ★ 1 - Blazer ★ 3 - Delta Vans

Many Used Cars Too Numerous To Mention. Check the windshields of our Used Cars for never lower, Patio Sale Prices.

WE ARE READY TO SELL — Besides regular discounts most of these cars were purchased before the last 3 price raises — an added savings for you!

HERE ARE JUST 2 EXAMPLES OF THE SAVINGS

C-51 New 1979 Caprice, 4 door, 305 V-8, automatic, its got everything including tilt wheel, cruise control, AM-FM radio, 50-50 seat, pastel blue with blue vinyl top. List \$8,567.15. Patio Sale Price \$7,130.00.

T-121 New 1979 Chevrolet 1/2-Ton 4-Wheel Drive Scottsdale, tinted glass, radio, power steering, power brakes, gauges, L70 8x15 mud and snow tires, air conditioning, special wheel covers, cargo light, intermediate wipers, tilt wheel, inside-hood release, clock, chrome grill, heavy duty transmission cooler, deluxe tu-tone in blue and white. List \$9,846.40. Patio Sale Price \$7,945.00.

HOURS  
Monday thru  
Friday til 8 p.m.  
Thursday til 9 p.m.  
Saturday til 4 p.m.

**CORYELL Chevy - Olds**  
Just West of Wayne on Hwy. 35 — Phone 375-3600

RED HOT PATIO DEALS, THIS IS NO SMOKE — RED HOT PATIO DEALS, THIS IS NO SMOKE — RED HOT PATIO DEALS, THIS IS NO SMOKE — RED HOT PATIO DEALS, THIS IS NO SMOKE — RED HOT PATIO DEALS, THIS IS NO SMOKE

PATIO DEALS, THIS IS NO SMOKE — RED HOT PATIO DEALS, THIS IS NO SMOKE — RED HOT PATIO DEALS, THIS IS NO SMOKE — RED HOT PATIO DEALS, THIS IS NO SMOKE — RED HOT PATIO DEALS, THIS IS NO SMOKE



# EDITORIAL PAGE

The liberty depends on the freedom of the press, and that cannot be limited without being lost. — Thomas Jefferson, Letter, 1786.

## America's 20th century pioneers

**RICHARD L. LESHER, PRESIDENT  
CHAMBER OF COMMERCE  
OF THE UNITED STATES**

It's a story that deserves to be told. For our purposes, let us pick it up in 1966 when they arrived in British Columbia as immigrants from the Netherlands. Things seemed bleak at first; they knew no one, he had no prospects for work, and only enough money to afford lodging in a third-rate hotel where they were told they must sleep on the floor. But they did have hope, and each other, and an enthusiasm, spirit and discipline — indeed a total commitment — to realize their shared dream of eventually becoming Americans and living a better life in the United States.

Today, the Waliszewicz family, Herman, his wife, Vera and their three sons, Max, 15, Lehman, 13, and David, 12, have already realized that dream and much more. Indeed, they are living proof of Harry Emerson Fosdick's belief that free democratic societies are strong and endure because "there are extraordinary possibilities in ordinary people."

It didn't take Mr. Waliszewicz long to locate his first position as a project engineer for the Park and Tilford Company in British Columbia, nor for him and his wife to save enough money to make a down payment on their first, very modest home. By 1969, his engineering abilities earned him a better offer from the Arthur G. McGee Company in Cleveland, and the family jumped at the chance to live in the United States. . . and in a better home. But they only stayed there a year, as Herman's reputation had already caught the attention of the U.S. Industrial Chemicals Company in Tuscola, Illinois.

Today, they live in nearby Champaign, Ill. Herman now works as group leader of USICC's engineering division. Vera works too, selling jewelry in Robson's, a downtown department store. Thanks to all their work and sacrifices and promotions, Herman and Vera now own two homes — their present residence in Champaign, and their former home in Cleveland which they rent. That's pretty impressive after starting from scratch just 13 years ago. But it's really just the beginning of this family's amazing story.

You see the Waliszewicz sons, Max, Lehman and David, not to be outdone by their parents, bought a home themselves in 1977 for \$40,000. How did they do it? Each one saved nearly every cent he earned over a four-year stretch delivering papers; then they combined their savings and pledged the entire amount toward an \$8,000 down payment. Of course Dad did have to chip in with the

final \$1,800, but the boys have already paid half of that back. The brothers now rent the house, make the necessary repairs with a little help from Mom and Dad, and use the money from the monthly rent payments to meet their tax and mortgage obligations. And that leaves them free to start saving again for their next anticipated investment — a college education. In the interim, they will have gained a practical education most people don't get until they're 30.

Our office got a taste of just how businesslike these young landlords are when we called the Waliszewicz family. The boys weren't here — probably out delivering the Champaign News-Gazette or fixing a faulty faucet in their house — but they did have their own recording which beeped, and then courteously requested us to leave our message.

When we did talk to the boys, we got a feeling of their responsibility, their motivation, in essence — their character. "You have to always make sure everything is right," said 12 year old David about his house. Lehman told us that when he's feeling "happy" he can deliver his papers in 15 minutes. (He admitted he takes longer when he knows they're having spinach for dinner.) Max, who first had the idea to invest the brothers' money in something that would appreciate in value, has a room full of stereo equipment bought with a little money and lots of bargaining skill.

Together, the boys have won bikes, and even a trip to Florida, as first prizes in contests run by their local paper to gain new subscribers. Through it all, they find plenty of time to watch television, see friends and play ball. But they sometimes wonder how others their age can accept allowances without doing any work.

Writer George Will recently observed: "For nations, as for individuals, character is destiny." The members of this remarkable family know precisely where they are going. They are going up, and they also know why. They know that to succeed, besides hard work, they basically need only two things: The discipline to live within a budget, to live below their yearnings, and the wisdom to invest well for tomorrow, rather than to spend for today. As David says, "If you look at my shoes, you might think I was poor, but I'm not!"

Our government insists on the opposite spending approach. Do you think it just a coincidence that our economy is also headed in the opposite direction — down? Could it be that our government's greatest minds lack the simple common sense of a 12 year old boy?

When we did talk to the boys, we got a feeling of their responsibility, their motivation, in essence — their character. "You have to always make sure everything is right," said 12 year old David about his house. Lehman told us that when he's feeling "happy" he can deliver his papers in 15 minutes. (He admitted he takes longer when he knows they're having spinach for dinner.) Max, who first had the idea to invest the brothers' money in something that would appreciate in value, has a room full of stereo equipment bought with a little money and lots of bargaining skill.

Together, the boys have won bikes, and even a trip to Florida, as first prizes in contests run by their local paper to gain new subscribers. Through it all, they find plenty of time to watch television, see friends and play ball. But they sometimes wonder how others their age can accept allowances without doing any work.

Writer George Will recently observed: "For nations, as for individuals, character is destiny." The members of this remarkable family know precisely where they are going. They are going up, and they also know why. They know that to succeed, besides hard work, they basically need only two things: The discipline to live within a budget, to live below their yearnings, and the wisdom to invest well for tomorrow, rather than to spend for today. As David says, "If you look at my shoes, you might think I was poor, but I'm not!"

Our government insists on the opposite spending approach. Do you think it just a coincidence that our economy is also headed in the opposite direction — down? Could it be that our government's greatest minds lack the simple common sense of a 12 year old boy?



## Give Energy Act time to work

BY GEORGE H. LAWRENCE

**AMERICAN GAS ASSOCIATION**  
The National Energy Act of 1978 and its natural gas pricing provisions have been criticized by those who say it has failed in its major purpose: to stimulate energy production while at the same time protecting the American residential energy consumer from exorbitant price increases.

The aggressive support by President Carter of the Natural Gas Policy Act (NGPA), the centerpiece of the National Energy Act, was the significant first step toward a realistic national energy policy. As to the criticism of the legislation, which became effective only last December, it is far too early to make judgments on the extent of its failure or success. However, the legislation does represent a major commitment on the part of the federal government to develop an energy policy national in scope, definite in purpose and equitable in implementation. It promises to deliver more domestic energy, benefiting consumers by helping reduce higher cost oil imports and by helping to stem the tide of rising inflation which is harming the U.S. economy.

Critics of NGPA contend that the Act is not going to stimulate more natural gas production. The facts contradict this claim. Even at this early date the indications are that passage of the NGPA is playing a significant role in encouraging the production of gas energy from domestic onshore wells.

The planned investment by the gas production industry for drilling, exploration and production is now rising sharply — 1979 figures are running 14.4 percent over 1978 figures — indicating a determination by the industry to boost gas production.

Gas well completions during the first several months of 1979, after the NGPA was law, were up nearly 30 percent over the same period in 1978, before the Act was law.

In 1978, deep well drilling was up over 60 percent from the previous year as gas producers, anticipating passage of NGPA, expanded their exploration efforts.

The bill facilitates plans to bring natural gas from Alaska to the lower 48 states by exempting from its incremental pricing regulations the huge gas reserves at Prudhoe Bay. Now the engineering, financing and regulatory clearance phases of the Alaskan gas pipeline project are underway; by the mid-1980s the 4,800 mile pipeline should be completed, bringing new gas supplies to the nation's consumers.

Industry studies predict that the NGPA will stimulate significant increased production of gas — nearly 8.5 trillion cubic feet through 1985.

It is also important of note that increased gas prices are predicted to rise because of NGPA only about 3

percent per year, plus inflation, between now and 1985. The combined average during that time will likely be in the 10 percent range per year. If efforts to arrest inflation are successful, this will, of course, be less.

In fact, the share of disposable family income spent on gas for householding is forecast to decline — from 1.5 percent in 1977 to 1.4 percent in 1985, according to an analysis by the American Gas Association. In fact, the average American family is spending the same proportion of its disposable income for gas heat today as it did in 1960. And by 1985 it is estimated that family will be spending an even smaller proportion.

The cost of all energy is going to rise, but passage of the natural gas provisions of the energy bill mean that clean, efficient gas energy will remain the consumer's best buy and that increased supply will be available.

Within the next few years, it will be increasingly recognized that the NGPA was the first step toward ensuring that America will have affordable and available gas energy far into the future.

## Eliminate 'carryover'

**NEBRASKA FARM BUREAU  
FEDERATION**

BY M.M. VAN KIRK  
DIRECTOR OF INFORMATION

Young farmers and ranchers, particularly those who have prospects for inheriting and carrying on the family farming and ranching operation, have a tremendous stake in supporting repeal of the so called "carryover provision" in the 1976 Tax Reform Act.

Currently, there are some 10 bills introduced in Congress to accomplish this repeal, including one by Nebraska 3rd District Representative Virginia Smith. Most farm fathers and mothers are interested in seeing a son or daughter and her husband take over the farming operations if they are inclined to do so, and as a matter of practicality, family help and inheritance is the only way young people can get a start in the high priced, high capital investment business of farming and ranching.

Here is what this "carryover provision" is all about. While the Tax Reform Act of 1976 provides tax relief for estates, especially those involving a farm or small business, one provision establishes a new, cost basis carryover on property for estate taxes.

That provision was that when heirs sell inherited property, the value of such property for tax purposes will be either the original purchase price or the fair market value as of Dec. 31, 1976, whichever is greater.

For farmland, the appreciation in value will be prorated by a straightline apportionment method based on the amount of time the property was owned before Jan. 1, 1977. The less time such farmland was owned before the provision takes effect, the greater the appreciation will be taxable.

Under the old law (still in effect because Congress has delayed implementation of the provision until Jan. 1, 1980), the tax basis of inherited property was

"stepped up" to its fair market value at the time of the decedent's death. Later, when an individual sold this inherited property, taxes were paid on the difference between the selling price and the "stepped up" value of the property. Any appreciation before the inheritance was not taxed as income.

Those who oppose elimination of the "carryover provision" have argued that such action encourages retention of wealth. Actually, heirs will be more reluctant to sell inherited property because of the prospect of increased capital gains taxes. It is well recognized that the big increases in land values which have occurred annually since 1972 have largely been the result of inflation rather than the land's increase in productivity and earning capacity.

Suppose a young farmer's father purchased his farm for \$60,000 and died when it was worth \$120,000, leaving it to the son. Assume that the son after a number of years of ownership and operation decided to sell the farm for \$150,000. His gain over what his father paid for the land would be \$90,000, but his gain over the farm's value, when his father died and he inherited it, would be only \$30,000.

The way the law is written, it must be determined what the fair market value of the land was on Dec. 31, 1976 and this feature was held by some as a "fresh start" when the law was passed. Farm organizations opposed that provision then and pointed out the growth of inflation and problems that are piling up as the years pass and farmland values double and triple.

The "carryover" will have to be figured out not only for the land but for buildings, machinery, etc. and such calculations can become potential night mares as adequate records become more difficult to produce with every year that passes. The legal entanglements and expense are easily visible.

Reportedly, White House sources have said President Carter would veto any bill that repealed "carryover" or again postponed a solution. The carryover provision was not practical in 1976 and with inflation intensifying, it makes less logic now. The best answer is to eliminate it from the law before it takes effect.

## OUT OF OLD NEBRASKA

by the  
Nebraska State  
Historical Society

## At the Front in France: 1918

Luther Swanson of Oakdale served as a lieutenant in the Army Engineers during the First World War. Some of his letters have been preserved in the State Archives at the Nebraska State Historical Society. The one which follows gives a vivid picture of the constant shellfire and sticky French mud which plagued the soldiers in the front-line trenches:

"At the front (Northern France) "E" Co., 1st U.S. Eng. Army Expeditionary Force, Feb. 24, 1918

"Dear Folks: This is Sunday, but not a day of rest, as we work straight through every day getting ready for the German offensive that is coming. The men have one day off in seven, to get cleaned up and rest, but the work has to go on, so one seventh of the men are off each day and the officers never.

"Fritz is sending over a few tonight and the sentry in front of our dugout is down in the entrance hugging the wall. Our fair city here has been pretty thoroughly shot up already and getting more so every day. Every house here is in ruins and nothing left but heaps of stone with a few walls left standing, except for the chateau, which isn't as badly knocked to pieces as the rest of the town. The house next door was all gone but the chimney, which was still standing unhurt up to last night. I was going to get a picture of that chimney, but last evening a shell got it so that's gone too.

"The material yard, we call it the dump, where the little toy railway, unloaded our material, gets shelled about twice a day. After the storm is over the lieutenant in charge goes out and gets his men out from whatever they're hiding under and starts them at work again.

**ALL BURNED UP!**

**WE ALL WANT TO HEAR ABOUT IT!**

**WRITE A LETTER TO THE EDITOR**



## WAY BACK WHEN

30 Years Ago

June 16, 1949: John K. Parke, son of K. J. Parke, has taken an examination to be advanced to the rank of seaman, first class, according to work received by his father. . . Mrs. Arthur McCain, Winslow, returned Friday from North Dakota where she went by plane from Wayne to Fargo. She attended to business interests and improvements on her ranch and visited at the home of Faye Stringer, who lives near Tower City and Fargo. She reported much excitement and activity around her place near Denhoff. A petroleum company from Tulsa, Okla., is there surveying and everyone is talking "oil". Mrs. McCain refused competitive offers of mineral rights on her place, but says neighbors' lease for them. She has decided to keep her place in fact until the oil prospects prove to be real and not a hope.

25 Years Ago

June 17, 1954: Cats belonging to Mrs. Mabel Henschke are not satisfied with having just nine lives. They also have a thumb. Mrs. Henschke told a Herald reporter Saturday that her cat had given birth to four kittens. Each of the new youngsters has a thumb-like appendage on its paw. The mother has a similar thumb. . . American Guernsey Cattle Club today announced election to membership of Wayne Gilliland, Wayne. . . Dr. John G. Nelhardt, poet laureate of Nebraska and Wayne State alumnus, will return to Wayne next week to participate in the annual Wayne State summer reunion Friday, June 25. . . MA had a double meaning for Mrs. Jerry Lightner, the former Ardnye Stevens, daughter of J.W. Stevens, Wakefield, last week for on Wednesday, she received her masters degree from Colorado State College of Education and became a "ma" to John Tracy, a 5 lb., 10 oz. son, at Weld County General Hospital. Not to be out done, Mr. Lightner qualified for a MA degree at the college, but had to settle to just plain old "pa" as far as the baby was concerned.

20 Years Ago

June 18, 1959: Electrical consumption in Wayne reached a new record 24-hour total Tuesday, Light Plant Sup. N.H. Brugger reported Wednesday. Brugger said a total of 30,500 kilowatts was generated at the municipal plant. This exceeded the previous record of slightly over 28,000. W.A. Brandenburg, Wayne, was named grand orator and Ralph M. Carhart, Wayne, was appointed grand senior deacon of the Nebraska Mason lodge posts by grand Master Joseph C. Tye, Kearney, last Wednesday. . . Milking nearly 50 cows is only a two-boy operation at the Felix Dorcey farm 1 1/2 miles west of Wayne. Using herringbone stanchion system, automatic feeders and a six unit pipeline milker, Mark Dorcey, 17, and his brother, John, 15, handle the whole chore.

15 Years Ago

June 11, 1964: Rev. Cecil Bliss, 31, has been assigned by the Methodist center office to serve as pastor for First Metho dist. Church, Wayne. He replaces Rev. William Palmer, who will leave today (Thursday) for his new pastorate at North Platte. . . Wayne County Extension Council has named Mrs. Basil Osburn as Rural Homemaking of the year. . . A.C. Frederick R. Rickers, son of Mr. and Mrs. Fred Rickers, Wayne, has been awarded the American Spill Honor Medal at Sheppard Air Force Base, Tex. . . Sale of Olson's Jewelry, Wayne, was announced Friday by Mrs. C.N. Olson. New owner is Dale Cutshall of Norfolk. Gulshall plans to move his family to Wayne as soon as suitable housing is located.

10 Years Ago

June 12, 1969: Richard E. Davis, 23, son of Mr. and Mrs. Earl Davis, Pilger, and grandson of Mr. and Mrs. George Peters, Wayne, graduated June 4 from the U.S. Merchant Marine Academy at Kings Point, N.Y. Davis graduated with honors, ranking in the upper seven percent of his class of 213 cadets receiving bachelor of science degrees and commissions as ensigns in the Naval Reserve. . . A crowd of 450 attended the 1969 Northeast Nebraska Home Talent Show at Laurel Tuesday night which was won by 18 voice Laurel chole. . . Wayne State College has received a federal grant of \$20,363 under Title VIIA, Higher Education Act 1965. President W.A. Brandenburg said Wednesday. . . Kathy Nelson, daughter of Mr. and Mrs. Orville Nelson, Wayne, earned a grade point average of 4.0(A) at the University of Nebraska in Lincoln last semester.



**PERSONALIZED**

## Playing Cards

Reader impressed

Council Bluffs, Ia.

Dear Editor:  
Enclosed is a check for \$1. Please send us a copy of the group picture taken on June 2 of the Class of '29 reunion.

We are very impressed with the accurate write up of our weekend in The Wayne Herald. We also think the photos are excellent and your printing very clear and easy to read. You should be congratulated.

Thank you. — D. Eugene and Doris Wind.

Order at  
**The Wayne Herald**  
Quick Delivery!

# GREAT VALUES

1022 Main  
375-1444

## SAV-MOR DRUG

Prices Effective  
Until June 23

THE LOFT

Walgreen  
AGENCY

Wayne, NE

**Soft-Dri**

NON-STING  
ANTI-PERSPIRANT  
• SCENTED

**89¢**

2.5 oz.  
1.69 VALUE

**FATHERS DAY SPECIAL  
LCD QUARTZ WATCHES**

Shows Continuous  
Digital Time plus  
Month, Day & Seconds

**2 For 1  
BUY ONE AT  
\$32.98  
GET ONE FREE**

**Summer's Eve**

- Regular
- Herbal

**71¢**

TWIN PAK 1.39 VALUE

**BRECK  
Shampoo**

- Normal
- Dry
- Oily

**99¢**

7 oz.  
1.83 VALUE

## DAD'S NO. 1 HERE

**POLAROID SPECIALS  
POLAROID MINUTE MAKER**

Value **1/2 PRICE** \$12.25

ALSO  
**SUPER SHOOTER**

Value \$27.95 **ONLY \$19.99**

Takes 6 Types of Film

**Colgate**

**INSTANT  
SHAVE**

**67¢**

1.38 VALUE

**CAMPHO-  
PHENIQUE  
LIQUID**

**\$1.16**

2 oz.  
1.98 VALUE

**OUTDOOR  
FLAG  
KIT**

3x5ft. \$7.99 Value  
**\$4.88**

Pole, Bracket, Rope  
& Hardware Included

**METAMUCIL \$4.79**

LAXATIVE  
21 oz.

7.29 VALUE

**Pepto-  
Bismol**

**66¢**

1.05 VALUE

**ALBERTO  
VO5  
Hair Spray**

• Regular (7 oz.)  
• Non-Aerosol (8 oz.)

**96¢**

1.49 VALUE

Get 2  
For The  
Price  
of One

**FLICKER**

TRIAL SIZE  
**2/49¢**

**Tame**  
conditioning  
clean rinse

• Dry to Normal  
• Oily  
• Extra Body

**92¢**

8 oz.  
1.69 VALUE

**Colgate**  
TOOTHPASTE

**\$1.29**

9 oz.  
2.49 VALUE

**RIGHT  
GUARD**  
ANTI-PERSPIRANT  
• SILVER SCENTED

**89¢**

2.5 oz.  
1.69 VALUE

**KLEENEX**

**29¢**

100's  
.49 VALUE

**JOHNSON & JOHNSON  
BAND-AID**

Plastic  
All Wide  
30's

**88¢**

1.69 VALUE

**Visine  
Eye Drops**

**\$1.11**

1/2 oz.  
1.90 VALUE

**Johnson & Johnson**

**Soff  
Puffs**

**59¢**

100's  
1.32 VALUE

**BUF-PUF  
CLEANING SPONGE**

**\$1.59**

2.69 VALUE

**PhisoDerm**

**\$1.22**

5 oz.  
1.98 VALUE

### Cars, Trucks Registered

#### WAYNE COUNTY CAR REGISTRATIONS

- Daniel Johnson, Wayne, Kaw 1979  
Francis Haun, Wayne, Kaw 1979  
Shawn Kell, Wayne, Kaw 1979  
Scribner, Roadside Dairy Farm, Winside, Fd Pkg 1979  
Lunder Construction, Wayne, Dtd 1978  
Gerrald Conway, Wayne, Toy 1978  
Scott Mann Hoskins, Chev Pkp 1978  
Gene Schroeder, Wskfield, GMC Van 1978  
Albert Anderson, Wayne, Dtd 1978  
Brian Kell, Wskfield, Pont 1978  
Jill Fraenlich, Wayne, Buick 1978  
Merion James Carroll, Chev Pkp 1978  
Coyell Auto Co., Wayne, Chev 1978  
Alfred Koplin, Wayne, Buick 1977  
Gerrald Stallins, Winside, Fd 1977  
Reed Anderson, Wayne, Honda 1977  
Howard Voss, Hoskins, Fd 1977  
Mid West Ornamental Iron, Wayne Toy Pkp 1977  
Dennis Schuler, Wayne, Dtd 1976  
Brad Jones, Wayne, Kaw 1976  
Sax-Mor Drug Inc., Wayne, Fd Pkp 1975  
Henry Warrelman, Wayne, Chev 1975  
Charles Kay, Wayne, Chev 1975  
Brian Kell, Wskfield, Kaw 1974  
Kay Modular Home Moving, Wayne, Chev Pkp 1974  
Dorothy Livermore, Wayne, Chev Pkp 1974  
Henry Brothers, Inc., Wayne, Fd Pkp 1973  
Maureen Olson, Emerson, Chev Pkp 1973  
Bradley Roberts, Carroll, Pont 1973  
David Christian, Wayne, Buick 1972  
Zakwan Plastics, Winside, Merc 1972  
Winifred Steward, Winside, Linc 1972  
Alma Kay Longgig, Winside, Buick 1972  
Way Lindsey, Carroll, Chev 1972  
Martin Freund, Wayne, Chev 1971  
Mike Maske, Wayne, Pont 1971  
C. Reber, Hoskins, Fd 1970  
Pauline Mauer, Hoskins, Fd 1970  
Scott Miller, Hoskins, Fd 1970  
Clifford Jones, Wayne, Fd Pkp 1968  
Lorraine Patterson, Wayne, Merc 1968  
Robert Nelson, Wayne, Chev 1968  
Milton Lamb, Wayne, Chev 1967  
Ivan Jensen, Wayne, Linc, Trk 1966  
Steve Hall, Wayne, Dtd van 1964  
Brian Kell, Wskfield, GMC, Trk 1964  
Perry Jones, Carroll, Fd Pkp 1965  
Lurt Wheeler, Wayne, Chev 1960  
Lynn Upton, Wayne, Chev, Pkp 1960  
Edward Eberley, Hoskins, Fd Pkp 1960  
David Miller, Wayne, GMC Pkp 1960



**Rain Puts Damper on Activities**

THINGS WERE a little dismal because of the drizzle and rain which fell during the first day of the Winside Old Settlers Reunion Saturday. Getting out of the weather with umbrellas are Cheryl Mason (left) and Connie Bergstadt.

**Red Baron Pizza**  
is here!

Now in your grocer's freezer.

**Red Baron**  
FROZEN PIZZA

# WINSIDE NEWS

Mrs. Andrew Mann  
286-4461

## Ladies Aid Meets June 6 at St. Paul's Lutheran Church

St. Paul's Ladies Aid met with 31 members on June 6. Guests were Mrs. Dan Jaeger and Jessica, Mrs. Dave Jaeger and Joanne, Mrs. Adolph Perse, Mrs. Hoskins, and Mrs. Don Lantz and Tammie, Pierce. Mrs. Gary Kant conducted the business meeting. Mrs. Karl Frederick had opening devotions, which included a hymn. Mrs. Frederick also read "Is My Life Going Flat?" Devotions closed with group singing of "My Hope is Built on Nothing Less." Mrs. Russell Hoffman read the treasurer's report in the absence of Mrs. Dean Kant.

Mrs. Kant thanked members who helped at the annual alumni banquet.

Snack bar reports were given by Mrs. Ida Fenske, Mrs. Louie Willers, Mrs. N. L. Diltman and Mrs. Richard Miller. Snack bar workers June 8 were Mrs. Al Carlson and Mrs. Cyril Hansen. Mrs. Fred Vahkamp and Mrs. Ray Reep will work at the snack bar on June 19.

It was announced that new curtains for the kitchen were donated by Mrs. Leo Hansen and made by Mrs. Lydia Witte. Lunch was served by Mrs. Leo Hansen and Mrs. Russell Hoffman. Next meeting will be at 2 p.m. on July 12 instead of July 4.

**Senior Citizens**  
Senior Citizens met at the Winside city auditorium June 5 for a picnic dinner. Twenty-five persons attended, and guests were the Rev. and Mrs. John Hafermann and family and Scott Jacobson.

Pitch furnished entertainment. The business meeting was conducted by president Mrs. Ella Miller, and coffee chairmen were Mrs. Otto Herrmann and Mrs. Dora Ritze.

**Walter League**  
Newly confirmed members of St. Paul's Lutheran Church were welcomed into the Walter League on June 6. It was announced that the name of the organization has been changed to Lutheran Youth Fellowship. The group is planning to have a league softball team this

summer. Plans are also being made for a square dance to be held in July. Dawn Janke was selected to represent the Waltham League at the District Youth Council. Pastor Hafermann had devotions. Lunch was served by Dawn and Della Janke and Kelly and Kim Leighton.

**Social Calendar**  
Thursday, June 14: Neighboring Circle, Mrs. Herb Jaeger. Friday, June 15: G.T. Club, Mrs. Minnie Weible; Neighboring Card Club; SOS Club. Monday, June 18: Eastern Star.

Tuesday, June 19: Tuesday Pitch Club, Cliff Burris; Senior Citizens. Wednesday, June 20: Tops Club; Friendly Wednesday, Mrs. Alfred Sievers; Scattered Neighbors; Busy Bees; St. Paul's Sunday school teachers.

**United Methodist Church**  
(Janet Baernstein, pastor)  
Sunday: Sunday school, 10 a.m.; worship, 11.

**Trinity Lutheran Church**  
(Lan DuBols, pastor)  
Sunday: Sunday school, 9:30 a.m.; worship, 10:30.  
Wednesday: Chapel time ves. pers.

**St. Paul's Lutheran Church**  
(John Hafermann, pastor)  
Thursday: Womens Bible study at the parsonage, 2 p.m.  
Sunday: Sunday school and Bible classes, 9:30 a.m.; worship, 10:30; pastor family visitation, church basement, 7 p.m.

Guests last Thursday in the home of Mrs. Edna Danberg were the Car, Fishers of Long Beach, Calif., the Henry Weese Iohs, Wayne, Mrs. Emil Thies, Angela, Debbie, Christie and April Thies, Mrs. Lillie Lippolt, Mrs. Fred Dangberg and Lorree, Missy Sanderson, the Milton Johnsons, Norfolk, and the Jay Wittses, Allen. The Duane McClarys, Sylvia, Kan., are visiting this week in the Hubert McClary home. They attended the McClary-Deming

wedding at Morningside, Ia. on Saturday. Sunday afternoon hosts in the Hubert McClary home to visit the Kansas guests were the Norman Jeppson family of Wakfield and the Fred Manns of Concord.

Darci Janke, Lincoln, spent the weekend with her parents, the Dean Jankes.

The Walter Hamms returned home June 7 after spending about two weeks in the home of their son and family, the Marylin Hamms of Nashville, Tenn. En route home they visited Hamms' aunt, Mrs. Jennie Hamm at Red Oak, Ia.

The Roger Thompsons, Kandis, Kent and Kimberly, Newman Grove, the Andy Manns and A.K., Norfolk, and Mrs. Dean Janke were supper guests Sunday in the Andrew Mann home.

Guests this past week in the Dennis Evans and Ed Helthold homes were Mrs. Donald Heitold, Grant and Carol of Houston, Mo., Paul Helthold of Florida, and Bill Helthold of New Mexico. They also visited relatives in Wayne, Hartington and Coleridge.

The Andrew Manns, Mrs. Dean Janke and Kandis Thompson of Newman Grove were in Colorado Springs, Colo. on June 6-8. Mrs. Mann visited an eye clinic there.

Saturday afternoon visitors in the St. Paul home were Bryce Lindsay of Colorado and Mrs. Amy Lindsay of Wayne. Sunday visitors in the Hamm home were Mrs. Judy Hamm and children of Bellevue, the Marvin Hamm family of Pender and Mrs. Helen Hancock and family.

Joanie Hamm, Pender, visited her grandparents, the Walter Hamms, June 13. Manns, Mrs. Roger Thompson and Kimberly of Newman Grove and the Dean Janke attended the wedding of Keith McClary and Catherine Deming at Morningside, Ia. Saturday.

Mrs. Eugene Miller and family and Larry Davenport of Omaha visited during the week end in the George Farran home. Mrs. Jeff Farran, Fremont, and the Roger Hills, Tecumseh, were also visitors in the Farran home. Hills were weekend guests in the Vernon Hill home.

WITTIG'S FOOD CENTER - WITTIG'S FOOD CENTER - WITTIG'S FOOD CENTER

WITTIG'S FOOD CENTER - WITTIG'S FOOD CENTER - WITTIG'S FOOD CENTER

### Quartered Chicken

For Grilling  
White or Dark **79¢** Lb.



### Dixie Pack chicken

Legs, Thighs & Breasts **89¢** Lb.

Bulk Wimmers **N.C. Wieners**  
**\$1.99** Lb. | **2 1/2 Lb. Bag - \$4.89**

Family Pack **Chicken**  
**47¢** Lb.

# Wittig's IGA

## Will Not Be Undersold

Every supermarket has weekly specials, and the prices on those items may be below IGA's regular shelf price . . . but when that happens, just follow three simple steps, and we'll SAVE YOU MONEY. It's as easy as 1-2-3.

- 1. Check all Wayne supermarket ads published this week.**
- 2. If you find an item with a price you like, just tear out the entire ad and take it to IGA.**
- 3. If our price isn't already lower than the competitor's, we'll meet their price.**

# Nobody Undersells Wittig's IGA

We Reserve The Right To Limit Quantities

### Pin on a little love...

with a pin-on button...FREE with every Hallmark Father's Day purchase of \$2.00 or more!  
Colorful buttons show you care — with designs to pin on Dad or wear yourself! Our wide selection of Hallmark cards and gifts for Dad is sure to please, too. So stop in today for all your Father's Day needs, and get a free button with your purchase!



### Dr. D. Koeber Attends Meeting Of Optometrists

Dr. Donald Koeber of Wayne attended the 74th annual convention of the Nebraska Optometric Association held at Scottsbluff June 7-9. The meeting centered on professional education, fellowship and business matters of the Association. Also appearing on the program were Dr. Wendell Waldie of Wichita, Kan., secretary-treasurer of the American Optometric Association, and Dr. Roger Truax of Albert Lea, Minn., president-elect of the North Central States Optometric Council. Retiring president Dr. B.G. Mullen of McCook presided at the business session. Dr. Richard Powell of Lincoln was elected president of the Association for 1979-80.

## TREAT DAD to Special Gifts

### DAD'S DAY GIFT CHECK LIST

- ✓ Pocket Watches
- ✓ Chain Bracelets
- ✓ Diamond Rings
- ✓ Money Clips
- ✓ Cuff Links
- ✓ Tie Tacks
- ✓ Neck Chains
- ✓ Pocket Knives
- ✓ Stone Rings
- ✓ Watches

Remember Dad Sunday—June 17

# THE DIAMOND CENTER

211 Main Waybe 375-1884

WITTIG'S FOOD CENTER - WITTIG'S FOOD CENTER - WITTIG'S FOOD CENTER

Prices Effective  
June 13-17.

Boneless Grilling  
**Ham Slices**  
**\$1.59**  
Lb.

Homemade  
**Pork Sausage**  
**79¢**  
Lb.

Wilderness Cherry  
**Fruit Filling**  
**89¢**  
21-Oz. Can  
Wilderness  
fruit filling

Teri White Decorated  
**Towels**  
Jumbo Roll  
**59¢**  
Teri

Nestea  
**100% Tea**  
3-Oz. Jar  
**\$1.85**

**7-Up or A&W Root Beer**  
6 Pack  
32 Oz.  
**\$1.59**  
Plus Deposit

Different Piece Available Each Week

Available Week 21" Tote Bag <b>\$9.99</b>	On sale at all times... Travel First Class with matching Luggage 24 Baggage \$13** 24 Business \$14** 29 Business \$16** 30 Luggage Bag \$16**
---	---

you're someone special at IGA

Clarence's Special  
**Wilson Whole Smoked Picnics**  
**79¢**  
Lb.  
WILSON'S CERTIFIED  
COPPA King

**Keebler Cookies**  
Vanilla Cremes, Fudge  
Cremes, Double Nutty  
**69¢**

**FROZEN FOODS SPECIALS**

**Pot Pies**  
Macaroni & Cheese, Chicken, Turkey or Beef.  
8 Oz. Banquet **4/\$1**

1 Gal. Plymouth Maid  
**Ice Cream**  
**\$1.99**

12 Oz. Hormel  
Reg. or Smoked  
**Spam**  
**\$1.19**

32 Oz. Del Monte  
**Catsup**  
**79¢**

**DAIRY SPECIALS**

1 Gal. Meadow Gold  
**Fruit Drinks**  
**69¢**

16 Oz. Roberts  
**Half & Half**  
**33¢**

**Cottage Cheese**  
24 Oz.  
Blue Bunny  
**98¢**

**BELDEN NEWS** / Mrs. Ted Leapley 985-2393

**Swimming Lessons Begin**

Registrations are being taken for swimming lessons at the Belden pool, with lessons beginning June 18. There will be beginners, intermediate swimmers, basic rescue and water safety, advanced life swimming and also classes for mothers and tots.

Presbyterian Church (Thomas Robson, pastor)  
Sunday: Worship, 9 a.m.; Sunday school, 10

Catholic Church (Robert Duffy, pastor)  
Sunday: Mass, 10:30 a.m.

Cheryl Koch of Concord will be lifeguard. The pool is open Monday through Friday, from 7 to 9 p.m. and from 7 to 9 p.m. on Saturdays and Sundays from 7 to 9 p.m.

Association Meets  
Ladies Cemetery Association met June 7 in the home of Mrs. Clarence Stapelman with Mrs. Cy Smith as co-hostess. There were 22 members present. Angela Fetters and Renee Sydow were guests.

Plans were made to paint the fence at the cemetery on July 5. The Association will entertain the senior citizens on Thursday, July 19, at the fire hall.

Following the business meeting Mrs. Freda Swanson and Mrs. Mildred Swanson were in charge of entertainment.

Betterment Builders  
The Belden Betterment Builders met June 5 in the fire hall with seven present. Work will start soon on the new tennis court.

A discussion was held concerning another fun day to be held in the fall.

Bridge Club  
The Bridge Club met Friday afternoon in the home of Mrs. Robert Wobbenhorst. Mrs. Clarence Stapelman was a guest.

Mrs. Robert Harper received high prize and Mrs. Doug Peterson received low prize.

Birthday Guests  
June 7 guests in the Ed H. Keifer home in honor of Mrs. Keifer's birthday were the Glen Kutzloffs and sons, Weeping Water, the Virgil Linds, Wausa, Lorenne Keifer and the Ed Fetters.

Friday afternoon lunch guests in the Mrs. Nellie Jacobson home were Mrs. Harry Gifford, Washougal, Wash.; Mrs. Freda Swanson and Mrs. Mildred Swanson, Laurel.

**A CLYDE CARD**

Cut me out and send me to someone. Put a smile on a face somewhere.

**Pierson Ins. Agency**  
111 West 3rd  
Phone 375-2696

WAS YOUR WIFE OUTSPOKEN?  
NOT BY ANYONE I KNOW.

**S.O.S.**  
Means That The  
**S**ecret **O**f **S**uccess  
**I**s  
**S**tarting **O**nes **S**avings  
**A**nd Then  
**S**avings **O**n **S**chedule  
**A**t

**ESLIC**  
MEMBER  
Federal Savings & Loan Insurance Corp.  
Your Savings Insured to \$40,000

**EQUAL HOUSING LENDER**

"Your Future Is Our Concern Today"

**WAYNE FEDERAL**  
Savings and Loan  
321 Main Street Phone 375-2043

**Lettuce**  
Crisp Head  
**4/99¢**

10 Lb. Calif. New White  
**Shafter Potatoes**  
**89¢**

Calif. **Peaches** **59¢** Lb.  
White Seedless **Grapes** **89¢** Lb.

# FARM PAGE

## Need to Bag Bagworms Now

The bagworm is a unique little insect that can cause severe injury to all evergreen trees and shrubs. It is known to feed on more than 90 kinds of ornamentals, but does not pose a serious threat on deciduous types of trees and shrubs.

Overwinters in the egg stage inside bags formed last year. Light infestations on small trees can be reduced by picking off the bags and destroying or taking them to the landfill. This must be done soon, as eggs may begin hatching in early to mid-June.

Several sprays are effective after eggs hatch. They are most useful when small bagworms are feeding in mid to late June, and July. After the bags are more than an inch long, control is difficult.

Products readily available for home use to control bagworms are diazinon, Cygon, and Orthene. Use strictly according to the labels.

## Trees Need Attention

Trees are an integral part of most home landscapes, but they often are neglected until they begin to do poorly. By then, it can be too late.

Most trees need fertilizer, especially if growing under adverse conditions, such as poor soil or subsoil, or are surrounded by asphalt or concrete, or choking on air pollution. Applications of fertilizer improve trees' general vigor. This increases their overall resistance or recovery from insects, disease and other adverse conditions.

Fertilizer also enriches the soil, which allows the tree to more efficiently make and use the food it produces.

Because most home owners rake up dead leaves from around trees in the fall, fertilizing becomes even more important. Without the leaves, trees lose many nutrients which would normally be returned to the soil as leaves decompose.

**Superior Speed Wash**  
**NOW OPEN**  
at  
**9th and Main**



## This and That... from YOUR COUNTY AGENT

### TICKS

I've had several reports of ticks being especially numerous this season. The American dog or wood tick is the species usually found in grassy or brushy areas. The first two life stages of this tick feed on rodents or rabbits, the third or adult stage will feed on most mammals—dogs and men. This tick is capable of transmitting spotted fever but the possibility is slight.

Precautions to prevent being bit include: 1) When entering a tick infested area, use a good repellent such as deer or sulfur dust around trouser legs and shoe tops. This is not a sure repellent but may help. 2) Examine the body after being in infested areas, especially hairy regions and the head, investigate any feeling of something crawling on you. 3) Remove clothing and leave them outdoors for a day after returning home.

If a tick is attached, remove it by grasping the head next to the skin and remove with a gentle, steady pull. Do not jerk. Treat the bite site with any antiseptic to prevent local infection.

If ticks are numerous in lawns, or for small areas mix two level tablespoons of 50 percent wettable powder to a gallon of water or use as a foliage spray.

### IRRIGATING ALFALFA

About 3.5 inches of water are required per ton of alfalfa if a two-ton cut of alfalfa is the objective. Then apply seven inches of water for each cutting of alfalfa.

### PRUNING EVERGREENS

Evergreens may benefit from pruning. Pruning evergreens is done to maintain the natural form of the tree, to prevent the tree from growing too wide or tall or to develop more dense foliage.

Pruning evergreens is not difficult. The important thing to remember is to use sharp equipment. It is best to prune regularly and make pruning cuts on the current season's growth. If branches are cut back beyond live foliage, new needles will not be produced and the branch will die.

Austrian pine should be pruned.



### Area 4-H'ers Attend Mini-Camp

Over 70 4-H'ers from a nine-county area in District III attended a 4-H mini camp at Wayne State College last week-end sponsored by the Wayne State Collegiate 4-H Club.

District III includes the counties of Dakota, Dixon, Wayne, Thurston, Knox, Antelope, Pierce, Cedar and Madison.

Theme for the mini camp, which was held for 4-H members 11 through 15 years of age, was "Promoting Positive Self-Image."

Registration was held Friday evening Workshops, which got underway Saturday morning, included yoga with Dr. Bob Johnson as the instructor; shrink art, taught by members of the Collegiate 4-H Club, including Jeannine Kroenke, Brenda Hunke, Judy Temme, Ania Peterson, Patty Sullins and Cheryl Pierson; and group dynamite (communications) taught by Roy Stohler, area youth specialist at the Northeast Station near Concord, and Collegiate 4-H member Laura Haase.

Following a noon luncheon, 4-H'ers were addressed by Kirk Hutton, admissions counselor at Wayne State College. The afternoon included a tour of the campus, a planetarium show, and "anything goes" competition.

Donna Hansen, 4-H leader in Wayne County, was guest speaker for a banquet Saturday evening.

The mini camp ended Sunday following a morning workshop service, swimming and skills.

**Pleasure and Profit 4-H Club**  
The Pleasure and Profit 4-H Club met June 4 at the fire hall in Allen. The meeting was called to order by the vice president, Jay Jones, followed with The Pledge of Allegiance and the 4-H pledge. Roll call was a favorite food.

Bicycle demonstrations were given by Kandace, Jay and Steve Jones, Derwin Roberts and Shane Maggart. Tractor demonstrations were by Derwin Roberts and Jay Jones. Kandace Jones gave a demonstration, entitled "O Brown Cow."

Next meeting will be June 23 at the Wakefield park with a swimming party planned.

The Roberts and the Jones served lunch at the close of the meeting.

Keith Karlberg, news reporter.

**Wayne Winners 4-H Club**  
The meeting of the Wayne Winners 4-H Club was held June 11 in the Kristie Craun home with six members and four mothers present.

Kristie Craun served lunch. The next meeting will be held June 28 at 6:30 p.m. in the Penny Paige home.

Dahl Reeg, news reporter.

## Farmers Agree to Cooperate In Using Solar Energy

Ten Nebraska farmers have agreed to cooperate with the USDA, US Department of Energy and the UNL Institute of Agriculture and Natural Resources Cooperative Extension Service to demonstrate the technical and economic feasibility of using solar energy to heat livestock buildings.

The project is intended to demonstrate the results of four years of solar research by the DOE and USDA and is funded in part by a \$173,700 grant from these agencies, according to Gerald Bodman, IANR extension agricultural engineer and project manager.

The project, according to Bodman, is a three year study designed to examine the econ-

omics of solar heating in swine, dairy and poultry production buildings.

Information obtained from the demonstration will be equally applicable to small and large scale operators," he noted.

"The project will be looking at what kind of incentives will be most successful to encourage the user to install a solar heating system."

Extension specialists from the UNL departments of agricultural engineering, ag economics and animal science, including swine, dairy and poultry production specialists will focus on the performance of the animals handled in the solar heated facilities, he said and also on what portion of the total heat

requirement can be produced by the solar units.

"Energy to heat ventilation air accounts for 70 to 80 percent of the total energy cost in animal housing units," Bodman explained. "There is no way to eliminate that cost. The producer has to manage energy use so it's most efficient and make sure he's not overventilating."

During the first year of the project, emphasis will be placed on design and installation of solar collectors at individual production sites, he said. Monitoring of the project will begin upon completion of construction at each site he said, and continue for two years. Deadline for completion of the installations is May 1980.

Bodman emphasized that livestock producers participating in the demonstration will contribute a minimum of 50 percent of the cost of the solar systems.

The project is a cost sharing endeavor between DOE/USDA and the states, he said, and it is a requirement of the contracts that the University contribute no more than half of the cost of the solar systems.

In finding participants for the demonstration he said, it was necessary to locate individuals who had expressed an interest in solar energy for heating their livestock buildings, and who were willing to invest their own money.

He said in the case of producers who are constructing a new building or modifying an existing building for the project the cost of construction, other than installation of the solar system, will be theirs.

Nebraska is one of nine states earmarked for solar demonstrations. Other agricultural oriented solar research at UNL

began in July, 1975 and includes a solar swine growing finishing house and a solar powered irrigation and grain drying system at Mead and a solar modified open-front swine growing finishing building on a private farm near Wahoo.

## Crop Yield Potential Determined by Seed

Crop yield potential is determined by the seed you plant. Nothing you do will increase this inherent potential. Everything that happens after planting serves either to maintain the potential or to reduce it. Pests, inadequate fertility, or drought at a critical stage are among recognized yield depressants.

Eliminating such problems helps growers to approach their yield potential but will not send yield beyond the built-in potential level.

When looking at a field of thousands and thousands of plants, we sometimes forget that the harvest from that field depends on the cumulative per-

formance of each individual plant. How far will each plant fall short in realizing its potential? That's what finally determines yield. Anyling that prevents 10 kernels from developing on each of 24,000 ears cuts per acre yield by almost three bushels.

Only 10 to 12 percent of the weight of a corn seed is in the embryo or germ and most of that is stored nutrients. Yet the tiny remainder is a miniature plant, which has the potential to develop into a full grownassel plant eight to 10 feet tall with 35 to 37 full-sized leaves in 60 to 70 days.

As a seed germinates and starts growing, the young shoot grows upward toward the soil surface. When the tip reaches light, it splits and allows the first leaves to unfurl. Every thing above-ground plant will ever be is inside that toothpick sized seedling. If all goes well, its production may approach its potential.

About the time the shoot

breaks through the soil surface a second (permanent) set of roots will begin to develop one or one and a half inches below ground level. This becomes the "crown" and several rows of ranks of roots may develop from this point upward on the stalk. This permanent root system soon takes over to nourish the plant as it grows and develops.

Just above the crown area of a corn seedling is the all important growing point which contains in miniature every above-ground plant part that will eventually develop. There are several cells representing each future leaf, a few representing the eventualassel and even some that will become ear shoots. As long as the growing point remains below ground level, the future plant is well protected from freeze, hail damage, and other weather-related damage.

The growing point is easy to identify. Simply split the stalk with a knife and look for a white colored Christmas tree-shaped structure. A dead or damaged one will be brown or black and may show the first evidence of rot and deterioration.

The growing point location is critical in case of late spring freezes, floods, hail storms, or attacks by certain insects. If anything damages or kills the

See CROP, page 7

Beauty your home with Masonite® Siding, then... collect \$50.00 and have a

## Housewarming Party

After re-siding your home with Masonite brand siding, you'll want to celebrate in style. And, why not? With a choice of colors and textures in horizontal lap or vertical panel styles, your home can take on a glowing new character. An original expression of warmth and hospitality. So Masonite Corporation will send you a check for \$50.00 if you reside your home with qualifying Masonite brand sidings between now and June 30, 1979. For complete details on how you can have a Housewarming Party on Masonite Corporation, stop in today.

Ask to see the Masonite brand sidings with the look of stucco, pecky cypress, rough sawn cedar and many more.

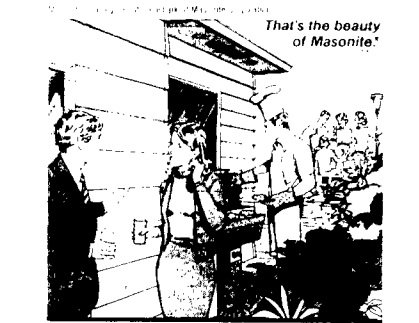

**Carhart LUMBER CO.**  
Phone 375-2110 Wayne, Nebr. 105 Main St.

## PUBLIC AUCTION

The Village of Winside will sell at public auction to the highest bidder — Lots, 19, 20, 21 and 22 — Block 1 Original Town in the Village of Winside. Each lot is 25' x 150' and will be sold as separate parcels. Auction to be held Saturday, June 23, 1979 at the Village Clerk's office with bidding to begin at 1:00 o'clock P.M. and close promptly at 2:00 o'clock P.M. 20 percent down payment required at auction with balance due on finality of sale and delivery of deed.

Village of Winside  
Marian Hill, clerk

**CALL 375-2082**

**To Schedule 2-4-D Application on your corn field**

**SHERRY BROS. HI-BOY IS ALL READY TO GO!**

**GET YOUR ORDER IN—TODAY!**

**SHERRY BROS. FARM & HOME CENTER**  
Phone 375-2082

## C'MON AMERICA! GET ON GOODYEAR

**FOR \$70**

A78 13 blackwall plus \$1.63 FET per tire and old tires

**Goodyear's Best Selling Diagonal Ply Tire**

Power Steerk 78 — Here it is, America, genuine Goodyear quality, and a fantastic value! You'll like the smooth-riding, dependable polyester cord body and six rib tread design, too, and the driving confidence you'll feel knowing you're on Goodyear tires!

**NOBODY OFFERS MORE THAN GOODYEAR!**

**\$38.95** 13500 Series Blackwall \$1.59 FET and old tire

**Tiempo Radial** 10,000 Siping edges for year round traction. Steel belts for strength. Polyester cord for smooth ride.

Blackwall Size	MSRP	MSRP	MSRP	MSRP
B78-13	\$42.00	\$42.00	\$42.00	\$42.00
F78-14	\$42.00	\$42.00	\$42.00	\$42.00
G78-14	\$42.00	\$42.00	\$42.00	\$42.00
H78-14	\$42.00	\$42.00	\$42.00	\$42.00
J78-15	\$42.00	\$42.00	\$42.00	\$42.00
K78-15	\$42.00	\$42.00	\$42.00	\$42.00
L78-15	\$42.00	\$42.00	\$42.00	\$42.00
M78-15	\$42.00	\$42.00	\$42.00	\$42.00

**GOODYEAR** Just Say Charge It

**BUY IT WITH CONFIDENCE. DRIVE IT WITH CONFIDENCE.**

**CORYELL DERBY**

Phone 375-2121 211 Logan Street



Happy Homemakers Hold Family Picnic

Nine members and their families of the Happy Homemakers Club met with the Marian Schopes June 4 for a family picnic. Mrs. William Domsch and Mrs. Darwood Wriedt were in charge of the entertainment.

The club is planning to have a demonstration booth at the Dixon County Fair. There will be a meeting and potluck lunch at 2 p.m. on Aug. 1 at the city park to make plans for the booth.

The officers and cultural arts leader Mrs. Mon Holmstrom are planning a cultural arts tour for the September meeting.

**Family Picnic**  
The Friendly Tuesday Club met Sunday at Graves Library for a family picnic with 18 attending.

The club will not meet again until Sept. 11 at 2 p.m. with Eleanor Park.

**Churchwomen Meet**  
United Presbyterian Churchwomen met at the park June 7 for a brunch. The churchwomen had their medical offering.

Mrs. A.L. Pospisil and Mrs. Raymond Paulson were hostesses.

They will not meet again until Sept. 6 at 2 p.m.

**Circle Meets**  
Salem Lutheran Church Circle 1 met with Mrs. John Boeckenhauer on June 7. Mrs. Otto Nelson gave the lesson. Mrs. Lloyd Anderson will host the July 5 meeting at 2 p.m.

Mrs. Norman Haglund hosted Circle 2 on June 7 with 12 members present. Mrs. Sam Ulecht gave the lesson. Mrs. Phillip Ring will be hostess for the July 5 meeting at 2 p.m.

Circle 3 met with Mrs. Thur Johnson on June 7 with 11 members present. Mrs. Sam Ulecht gave the lesson and will be hostess for the July 5 meeting at 2 p.m. in the church basement.

Mrs. Gerald Muller hosted Circle 4 on June 7 at 9:30 a.m. Mrs. Mauritz Carlson presented the lesson. Grace Sundell will host the July 5 meeting at 9:30 a.m.

Seven members of Circle 5 met June 5 at 8 p.m. Mrs. Marion Christensen was in charge of the lesson. "Support," Mrs. Jim Martindale will host the July 3 meeting at 8 p.m.

The Harry Larsons visited their son and wife, the William C. Larsons, in Columbia, Md., last week. While there they also visited Washington, D.C.

**Immanuel Lutheran Church**  
(Ronald E. Helling, vacancy pastor)  
Sunday: Worship, 8:30 a.m.; Sunday school, 9:30.

**Evangelical Covenant Church**  
(E. Neil Peterson, pastor)  
Sunday: Sunday school, 9:45 a.m.; worship, 11; Junior High

League, 5:30 p.m.  
Tuesday: CSC meeting, 7 p.m.  
Wednesday: Bible study and prayer meeting, 8 p.m.; church board, 9.

**Salem Lutheran Church**  
(Robert V. Johnson, pastor)  
8:30 p.m.: Church (council), 8:30 p.m.  
Sunday: Sunday school, 9 a.m.; worship, 10:30.  
Tuesday: XYZ group, 2 p.m.

**St. John's Lutheran Church**  
(Ronald E. Helling, pastor)  
Sunday: Vacation Bible school

closing program and picnic in the park, 10 a.m.  
Tuesday: Jews for Jesus.

**Christian Church**  
(Greg Hafer and Mike Lincoln, pastors)  
Thursday: Town and Country Bible study, 8 p.m.  
Sunday: Bible school for all ages, 9 a.m.; worship and junior worship, 10:30; junior and junior high youths meet, 7 p.m.; evening worship, 8.  
Sunday-Friday: Junior High will be at Camp Nebowa near Onawa, Ia.  
Wednesday: Ladies Bible study, 2 p.m.; adult Bible study, 8 p.m.

PUBLIC NOTICES  
BECAUSE THE PEOPLE MUST KNOW

**NOTICE TO CREDITORS UPON FORMAL APPOINTMENT OF PERSONAL REPRESENTATIVE**  
Case No. 4453.  
County Court of Wayne County, Nebraska.  
Estate of Clara Hoskinson, also known as Clara L. Hoskinson, Deceased.

Notice is hereby given that Marjorie Arlene Fuehrer, who resides at 413 Hillcrest Road, Wayne, Nebraska 68782, has been appointed Personal Representative of this estate. Creditors of this estate must file their claims with this Court on or before August 2, 1979, or be forever barred.

(5) Luverna Hilton  
Clerk of the County Court  
Deutsch & Hagen,  
Attorney for Petitioner  
(Publ. May 31, June 7, 14)

**NOTICE OF INFORMAL PROBATE AND APPOINTMENT OF PERSONAL REPRESENTATIVE**  
Case No. 4460.  
County Court of Wayne County, Nebraska.  
Estate of Fred R. Ulecht, Deceased.

Notice is hereby given that on May 24, 1979, in the Wayne County Court, the Registrar issued a written Statement of Informal Probate of the will of said Deceased and that Ardrath Ulecht, whose address is Rural Route, Wakefield, NE 68784 has been appointed Personal Representative of this estate. Creditors of this estate must file their claims with this Court on or before August 2, 1979, or be forever barred.

Luverna Hilton  
Clerk of County Court  
Charles E. McDermott  
Attorney for Applicant  
(Publ. May 31, June 7, 14)

**READ AND USE WAYNE HERALD WANT ADS**

**NOTICE OF FORMAL PROBATE, DETERMINATION OF HEIRS AND APPOINTMENT OF PERSONAL REPRESENTATIVE**  
Case No. 4461.  
In the County Court of Wayne County, Nebraska.  
In the Matter of the Estate of Lucretia Jeffrey, Deceased.  
State of Nebraska.  
To: All Persons Interested in Said Estate.  
Notice is hereby given that a Petition for Formal Probate of Will of said Deceased, Determination of Heirs and Appointment of Robert C. Jeffrey as Personal Representative has been filed and is set for hearing in the Wayne County Court on July 5, 1979, at 11 o'clock a.m.

(6) Luverna Hilton  
Clerk of the County Court  
B.B. Bornhoff  
Attorney for Petitioner  
(Publ. June 14, 21, 28)

**NOTICE OF FORMAL HEARING FOR COMPLETE SETTLEMENT TO DETERMINE TESTACY, AND FOR DETERMINATION OF INHERITANCE TAX**  
Case No. 4341.  
County Court of Wayne County, Nebraska.  
Estate of Erwin T. Warnumunde, Deceased.  
Notice is hereby given that the Personal Representative has filed a final account and report of his administration, a formal closing petition for complete settlement to determine testacy, and a petition for determination of inheritance tax which have been set for hearing in the Wayne County Court on July 5, 1979, at 10:30 o'clock a.m.

(6) Luverna Hilton  
Clerk of the County Court  
Olds, Swaris and Enz  
Attorney for Petitioner  
(Publ. June 14, 21, 28)

**WAYNE COUNTY BOARD PROCEEDINGS**  
Wayne, Nebraska  
June 3, 1979  
The Wayne County Board of Commissioners met per adjournment with all members present. The minutes of the preceding meeting were read and approved.

The notice of this meeting was published in The Wayne Herald, a legal newspaper, on May 24, 1979.

The following officers' reports of fees collected during the month of May and remitted to State and County Treasurers were approved as follows:  
Orgratta C. Morris, County Clerk -- \$322.00.  
Don Weible, Sheriff -- \$84.50.  
Joann Ostrander, CDC -- \$92.50

The following Resolution was adopted:  
RESOLVED, that whereas the deposits of this county in WINSIDE STATE BANK, WINSIDE, NEBR., Bank do not now exceed \$300,000.00, said bank is entitled to is hereby permitted to withdraw the following securities held in escrow by Omaha National Bank (trustee) to secure deposits of this county in said bank, to wit:  
US TREASURY NOTES due 11 6/74 due 5-15-79 .7875 percent Total \$50,000.00 BOOK ENTRY No. 228546

BE IT FURTHER RESOLVED, that the County Treasurer is hereby instructed that the maximum amount of deposits to which said bank is entitled is hereby reduced and that the county deposits in said bank shall not exceed the sum of \$300,000.00 until additional securities, approved by this board, have been deposited with said trustee as security for county deposits.

The foregoing resolution was moved by Pospisil and seconded by Eddie, and on roll call the vote resulted in all Ayes.

The following Resolution was adopted:  
RESOLVED, that whereas the deposits of this county in FIRST NATIONAL BANK, WAYNE, NEBRASKA, Bank do not now exceed \$15,000.00, said bank is entitled to and is hereby permitted to withdraw the following securities held in escrow by Federal Reserve Bank of Kansas City, Omaha, Nebraska (trustee) to secure deposits of this county in said bank, to wit:

**NOTICE OF FORMAL PROBATE, DETERMINATION OF HEIRS AND APPOINTMENT OF PERSONAL REPRESENTATIVE**  
Case No. 4470.  
In the County Court of Wayne County, Nebraska.  
In the Matter of the Estate of Lucretia Jeffrey, Deceased.  
State of Nebraska.  
To: All Persons Interested in Said Estate.  
Notice is hereby given that a Petition for Formal Probate of Will of said Deceased, Determination of Heirs and Appointment of Robert C. Jeffrey as Personal Representative has been filed and is set for hearing in the Wayne County Court on July 5, 1979, at 11 o'clock a.m.

(6) Luverna Hilton  
Clerk of the County Court  
B.B. Bornhoff  
Attorney for Petitioner  
(Publ. June 14, 21, 28)

**Every government official or board that handles public moneys, should publish at regular intervals an accounting of it showing where and how each dollar is spent. We hold this to be a fundamental principle to democratic government.**

**NOTICE OF FORMAL HEARING FOR COMPLETE SETTLEMENT TO DETERMINE TESTACY, AND FOR DETERMINATION OF INHERITANCE TAX**  
Case No. 4341.  
County Court of Wayne County, Nebraska.  
Estate of Erwin T. Warnumunde, Deceased.  
Notice is hereby given that the Personal Representative has filed a final account and report of his administration, a formal closing petition for complete settlement to determine testacy, and a petition for determination of inheritance tax which have been set for hearing in the Wayne County Court on July 5, 1979, at 10:30 o'clock a.m.

(6) Luverna Hilton  
Clerk of the County Court  
Olds, Swaris and Enz  
Attorney for Petitioner  
(Publ. June 14, 21, 28)

**WAYNE COUNTY BOARD PROCEEDINGS**  
Wayne, Nebraska  
June 3, 1979  
The Wayne County Board of Commissioners met per adjournment with all members present. The minutes of the preceding meeting were read and approved.

The notice of this meeting was published in The Wayne Herald, a legal newspaper, on May 24, 1979.

The following officers' reports of fees collected during the month of May and remitted to State and County Treasurers were approved as follows:  
Orgratta C. Morris, County Clerk -- \$322.00.  
Don Weible, Sheriff -- \$84.50.  
Joann Ostrander, CDC -- \$92.50

The following Resolution was adopted:  
RESOLVED, that whereas the deposits of this county in WINSIDE STATE BANK, WINSIDE, NEBR., Bank do not now exceed \$300,000.00, said bank is entitled to is hereby permitted to withdraw the following securities held in escrow by Omaha National Bank (trustee) to secure deposits of this county in said bank, to wit:  
US TREASURY NOTES due 11 6/74 due 5-15-79 .7875 percent Total \$50,000.00 BOOK ENTRY No. 228546

BE IT FURTHER RESOLVED, that the County Treasurer is hereby instructed that the maximum amount of deposits to which said bank is entitled is hereby reduced and that the county deposits in said bank shall not exceed the sum of \$300,000.00 until additional securities, approved by this board, have been deposited with said trustee as security for county deposits.

The foregoing resolution was moved by Pospisil and seconded by Eddie, and on roll call the vote resulted in all Ayes.

The following Resolution was adopted:  
RESOLVED, that whereas the deposits of this county in FIRST NATIONAL BANK, WAYNE, NEBRASKA, Bank do not now exceed \$15,000.00, said bank is entitled to and is hereby permitted to withdraw the following securities held in escrow by Federal Reserve Bank of Kansas City, Omaha, Nebraska (trustee) to secure deposits of this county in said bank, to wit:

The Wayne (Nebr.) Herald, Thursday, June 14, 1979

LINCOLN NE PUB ED FAC LEASE RENTAL REV BBS dtd 1-1-70 (LO OI) RBSI dtd 7-1-81 7 percent No. 29-077 at 5M Total: \$10,000.00 Cust. No. 042740 8

BE IT FURTHER RESOLVED, that the County Treasurer is hereby instructed that the maximum amount of deposits to which said bank is entitled is hereby reduced and that the county deposits in said bank shall not exceed the sum of \$45,000.00 until additional securities, approved by this board, have been deposited with said trustee as security for county deposits.

A motion was made by Pospisil and seconded by Eddie that the Schroeder Land Surveying Company of Norfolk be appointed as Wayne County Surveyor, paid on a case-by-case basis at \$26.00 per hour with 2 men. Roll call vote: All Ayes.

Clyde Flowers of Bruce Gilmore & Associates met with the Board to request that the County Surveyor set some sections corner.

Resolution by Pospisil and seconded by Seiermann to approve the appointment of Roy Sommerfeld as the new member of the Wayne County Veterans' Service Committee. Roll call vote resulting in All Ayes.

Resolution by Seiermann and seconded by Pospisil stated that the Wayne County shall not contribute financial support to the Greater Nebraska Health Systems Agency for the next fiscal year.

The following claim were audited and allowed. Warrants to be ready for distribution on June 15, 1979.

GENERAL FUND	Balance
Salaries	752.50
Wayne Twp. Telephone Co. May services	28.34
Monroe, supplies	14.50
Postmaster, Wayne, postage	417.50
Redfield & Co., Int. supplies and board of prisoners	125.29
International Business Machines, new equipment	670.00
Monroe, new equipment	374.09
NE Assoc. of County Clerks, annual dues	75.00
Postmaster, stamps	75.00
Des Moines Stamps Mfg Co., supplies	9.80
Norfolk Office Equipment, supplies, new equip., maint. contracts	756.05
Norfolk, maintenance of residents	19.45
Redfield & Co., supplies	20.74
West Publishing Co., supplies	41.50
Don, supplies and travel	17.75
Merchant Oil Co., mileage and travel	130.37
Windsor Motor, mileage and travel	24.38
Motrolite, Inc., maintenance contract	197.00
Wayne Twp. supplies	15.45
International Business Machines, supplies	68.08
Consolidated Engineers, bridge inspection	413.94
Redfield & Co., Int. supplies and board of prisoners	271.00
Wayne Refuse Service, May trash service	20.00
Western Paper Co., supplies	27.95
Belenman Electric, maintenance	35.88
Alb. Clark Products, supplies	11.00
R.C. Booth Enterprises, lamp maps	137.00
John W. Weible, May cleaning service	20.00
Xerox Corp., maintenance agreement	23.30
Xerox Corp., machine rental	30.57

REGIONAL CENTER FUND	Balance
Beatrice State Develop. Ctr., maintenance of residents	171.00

SPECIAL POLICE PROTECTION FUND	Balance
Sioux Valley Radio Eng. Co., new equipment	160.00

COUNTY ROAD FUND	Balance
Salaries	9,146.49
Nebr. Sand & Gravel, gravel	6,491.17
Consolidated Engineers, bi-monthly payment	541.66
Diers Supply, supplies	79.48
Fredrickson Oil Co., repairs	36.50
Merchant Oil Co., repairs, gas and grease	2,397.98
Mo. Valley Mch. supplies, repairs	2,145.87
Thies Brudigan, supplies	4.20
Wayne Auto Parts, supplies	94.15
Coryell Derby, supplies	6.79
Fredrickson Oil Co., repairs	4.20
Wayne Auto Parts, supplies	18.13
Wayne Auto Parts, supplies	6.34
Merchant Oil Co., oil	5.00
Ellis West Bridge & Construction, gravel	4,400.00
Wayne County Public Power Dist., May service	20.00
Diers Supply, supplies	30.24
Worms Machine Shop, repairs	21.00
Mo. Valley Mch. supplies and repairs	482.88
Schmides, Inc., supplies	77.39
Thies Brudigan, supplies, grease	8.20
Vic's Jack & Engine, supplies	30.20
Wayne Auto Parts, supplies	47.40
Windsor Motor, supplies	18.45
Windsor Motor, supplies	24.60
N & M Oil, gas	677.77
Husker Concrete & Gravel Co. gravel	8,931.44
Mid West Bridge & Construction, gravel	4,527.74
Nebr. Sand & Gravel, Int. gravel	4,782.52

**REVENUE SHARING FUND**  
Kahier Construction Inc., gravel  
Meeting was adjourned  
Orgratta C. Morris, County Clerk  
(Publ. June 14)

Top Graduate

MARK Allan Longe of Chisholm, Minn., graduated from high school there June 1 as valedictorian of the class of 109 students. Mark, who is the grandson of Mrs. Leona Longe of Wayne, received a scholarship to Hainon College for pre-law at St. Paul, Minn. He is the son of Dallas Longe of St. Paul and Aileen (Diamond) Hoover of Chisholm.

Because welfare benefits buy them better lodging, derelicts in New York's Bowery have dwindled from 13,000 to 5,000 in the past 10 years.

**STETSON**  
Custom Spring Service  
Specializing in Truck and Trailer Repair

from this to this

WILL DO COMPLETE JOB OR FURNISH PARTS

For Spring Service  
623 West 7th Street, Sioux City, Iowa 51103

**"Now no other bank or Savings & Loan can beat our current rate on Money Market C's."**

Looking for high interest on 182-day Money Market CD's? Come to State National Bank & Trust Company.

Interest rate rules have changed on 6-month, Money Market CD's. So if you're in the market for an outstanding short-term investment (\$10,000 minimum) with a guaranteed rate, talk to us. You won't find a better interest rate at any other bank or savings and loan. And your investment is insured up to \$40,000 by the F.D.I.C. Federal regulations require a substantial penalty for early withdrawal and prohibit compounding of interest during the term of deposit.

pays **9.047%** ANNUAL RATE on

**Money Market Certificates**

Stop in Today at the **The State National Bank and Trust Company**

Wayne, NB 68787 • 402/375-1130 • Member FDIC  
Main Bank 122 Main • Drive-In Bank 10th & Main

**Prices Effective 6/14 to 6/16**

**FRESH GROUND BEEF CHUCK \$1.59 lb.** (10lb. limit)

**BONELESS TOP SIRLOIN STEAK \$2.69 lb.**

**CHOICE CHUCK STEAK \$1.29 lb.**

**CHOICE No. 7 cut BEEF ROAST \$1.19 lb.** arm cuts \$1.39 lb.

**SMOKED PORK CHOPS \$1.89 lb.**

**WISCONSIN-COLBY LONGHORN Cheese THE NUTRITIOUS SNACK \$1.79 lb.**

**WHOLE PORK LOINS (17-20lb. avg.) \$1.19 lb.** (Processed & Frozen)

**WHOLE FRYERS 57¢ lb.**

HOURS: Monday-Friday - 8 a.m. to 6 p.m.  
Saturday - 8 a.m. to 1 p.m.  
Quantity Rights Reserved

**JOHNSON'S FROZEN FOODS**  
Phone 375-1100 Wayne 116 West Third

# SIRLOIN STEAK

tender taste® BEEF

# \$2.49

Lb.

Try These Juicy Sirloins on Your Grill

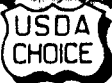

## This Week's Free Cash Bankroll

If you have never registered for Free Cash Bankroll, come in today, register and receive your free Punch Card. No purchase necessary and you need not be present to win!

# \$1400<sup>00</sup>

BE SURE YOUR CARD IS PUNCHED FOR THIS WEEK'S BANKROLL!

LAST WEEK'S NAME DRAWN: *Thure Johnson, Wakefield*

PRICES EFFECTIVE THRU TUESDAY, JUNE 19

BOSTON BUTT  
**Pork Roast** \$1.09 lb.

**Pork Steak** \$1.19 lb.



## FRUITS & VEGETABLES

# WATERMELON

Red Ripe and Full of Juice

# Lb. 10¢

Deliciously Sweet!

- Luscious California PEACHES lb. 59¢
- Red Beauty Variety CALIFORNIA PLUMS lb. 69¢
- Tender, California CELERY HEARTS Pkg. 79¢
- Juicy Slicers TOMATOES lb. 59¢
- Juicy California VALENCIA ORANGES 5-lb. Bag \$1.99
- For Easy Dessert Treat, Try HONEYDEW MELON Ea. 99¢
- Bunch Red Leaf LEAF LETTUCE 3 Bunches \$1.00

tender taste® BEEF CUBE STEAKS USDA Choice Lb. \$2.29

SWIFT'S BREAKFAST STRIPS SIZZLEAN 12-oz. Pkg. \$1.49

USDA CHOICE STEAK T-BONE Lb. \$2.79

COUNTRY STYLE PORK SPARE RIBS tender lean® Lb. \$1.29

PLEASMOR SLICED BACON 1-lb. Pkg. 99¢

FAMILY PAK FRYERS tender fresh® Lb. 53¢

HORMEL LITTLE SIZZLERS Sausages 12-oz. Pkg. 99¢

**BONUS BUY**

# NUSPRED

Quarters Margarine 1-lb. Pkg. **19¢**

Limit Two with \$10.00 Purchase or More

**BOTH BONUS BUYS** With \$20.00 Purchase or More

# VAN CAMP'S PORK & BEANS

Have Plenty on Hand All Summer Long

# 10¢

Limit Two with \$10.00 Purchase or More

**BONUS BUY**

WIMMER NATURAL CASING WEINERS lb. \$1.99

CROWN BRAND BOLOGNA CHUNK lb. \$1.19

SPLIT FRYERS lb. 69¢

LIBBY'S

- ★ PEAS ★ CORN
- ★ GREEN BEANS

3 17-oz. cans \$1.00



**LIQUID BLEACH** Our Lady Brand Gal. Jug **69¢**

**CHARMIN WHITE OR ASS'T TOILET TISSUE** 4-roll Pkg. **99¢**



THOUGHT FOR THE WEEK Positive thinking can expel negative thoughts.

**COUPON** ALL GRINDS COFFEE V-00

# BUTTER-NUT

2-lb. Can \$4.39 Limit One

Good Only at Jack & Jill through June 19, 1979

N.F.-LN

PRICES EFFECTIVE THRU TUESDAY, JUNE 19

**COUPON** BIG "O" CEREAL V-10

# CHEERIOS

15-oz. Pkg. 99¢ Limit One

Good Only at Jack & Jill through June 19, 1979

N.F.-LN

PLEASMOR POTATO CHIPS twin.pak 49¢

PLEASMOR MARGARINE lb. 44¢

**COUPON** Assorted Flavors

# HI-C FRUIT DRINKS

46-oz. Can 58¢

OLD HOME OLD SETTLER BREAD 2 loaves 99¢

**COUPON** BAKING MIX V-12

# BISQUICK

40-oz. Pkg. 99¢ Limit One

Good Only at Jack & Jill through June 19, 1979

N.F.-LN

GERBER'S STRAINED BABY FOODS Except Meats

5 Reg. Jars \$1.00

NESTEA INSTANT TEA 3-oz. Jar \$1.99

FAIRMONT HALF & HALF pt. 33¢

CRISCO SHORTENING 3-LB. CAN \$1.98

MIRACLE WHIP SALAD DRESSING 32-oz. jar \$1.08

DEWEY FRESH ORANGE JUICE 12-oz. can 79¢

**COUPON** ALL PURPOSE FLOUR V-20

# GOLD MEDAL

5-lb. Bag 69¢ Limit One

Good Only at Jack & Jill through June 19, 1979

N.F.-LN

**COUPON** SUNDAY ONLY BROASTED CHICKEN 9 PIECE \$2.99

FAIRMONT ICE MILK 1/2-gal. 99¢

VELVEETA CHEESE 2-lb. pkg. \$2.59

PLEASMOR COOKIES 3/\$1.00

COUNTRY COUSIN FRENCH FRIES 5-lb. bag \$1.35

PLEASMOR SUGAR 10-lb. bag \$2.35

DEWEY FRESH WHIP TOPPING 8-oz. tub 65¢

**Jack & Jill FOOD CENTER**

Monday thru Saturday 7:30 a.m. - 9 p.m.  
Sunday 9 a.m. - 9 p.m.

# PAMIDA DISCOUNT CENTER

EAST HWY. 35 - WAYNE, NE.

# SUMMER SALE

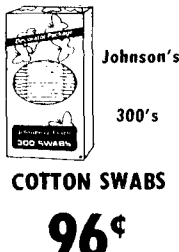
 <p>Johnson's 300's <b>COTTON SWABS</b> <b>96¢</b></p>	<p><b>LYSOL</b> Spray Disinfectant 12 Oz. Reg. \$1.87 <b>\$1.49</b></p>	<p><b>BATH BEADS</b> Vaseline Intensive Care 15 Oz. Reg. \$1.56 <b>\$1.09</b></p>	<p><b>ROSE MILK</b> Skin Care Cream 8 Oz. Unscented or Regular Reg. \$1.57 <b>\$1.29</b></p>	<p><b>METAMUCIL</b> 14 Oz. Reg. \$3.77 <b>\$3.19</b></p>	<p><b>GRAPE JELLY</b> Welch's 2 Lb. <b>99¢</b> White Quantities Last</p>	<p><b>LUX</b> Liquid Dish Soap 22 Oz. <b>89¢</b></p>	<p>Johnson's <b>BABY SHAMPOO</b> 16 Oz. <b>\$1.96</b></p>
--	---	---	--	--	--	--	---

PRICES EFFECTIVE  
WED., JUNE 13  
THRU SUN.,  
JUNE 17

<p><b>PRETZELS</b> 9 Oz. Bag Twist or Stick <b>3/\$1</b> Reg. 49¢</p>	<p>Pamida 300 Ct. <b>COSMETIC PUFFS</b> <b>2/\$1</b></p>
<p>Slim Jim <b>BEEF JERKY</b> Reg. \$1.96 3.25 Oz. <b>\$1.49</b></p>	<p><b>WD-40</b> Rust Remover <b>99¢</b></p>
<p><b>DENTYNE BONUS PAK</b> Regular or Spearmint <b>3/\$1</b></p>	<p>Johnson's 4 Oz. <b>BABY OIL</b> <b>96¢</b></p>
<p>Capri Foaming <b>BATH OIL</b> 64 Oz. <b>\$1.56</b></p>	<p>Planters Dry Roasted <b>PEANUTS</b> 24 Oz. Reg. \$2.29 <b>\$1.89</b></p>
<p><b>RENUZIT</b> Air Freshner 6 Oz. Solids <b>3/\$1.00</b></p>	<p>7 Oz. Solid <b>SANI FLUSH</b> Toilet Cleaner &amp; Deodorizer <b>69¢</b> Reg. 89¢</p>

**PLASTIC TABLEWARE**  
Reg. 43¢  
**29¢**

8 Knives  
8 Forks  
8 Spoons

**12 BAR VALUE PACK**  
Milky Way, 3 Musketeers or Snickers  
\$2.40 Value  
**\$1.49**

**TURTLE WAX LIQUID**  
12 Oz.  
**3.96**  
Reg. 4.96 ea. Home and garden duster. Flower Shower home garden sprayer. Use for indoor as well as outdoor plants.

**TURTLE WAX LIQUID**  
12 Oz.  
**99¢**

**2.96**  
SAVE 70  
Bird bath

**3.46**  
SAVE 1.50  
Oscillating sprinker

**1.99**  
SAVE 78  
Coronet 50 ft vinyl garden hose

**CORONET**  
100% VINYL  
50  
SAVE 78

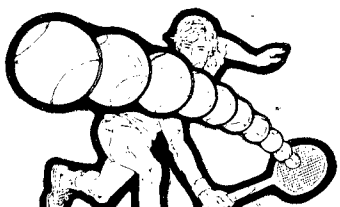

Wilson Championship  
**TENNIS BALLS**  
3 Balls Per Can  
**\$1.96**

**1.96**  
YOUR CHOICE  
10 in. high x 5 ft. long picket fence or 5 in. high x 10 ft. long border fence

**COUPON**  
PAMIDA  
**\$200 OFF**  
Any TENNIS RACKET in Stock

**74.97**

20 in. 3 h.p. rotary mower with 14 gauge steel deck, easy spin recoil starter engine, 7 in. wheels and polyethylene hubs. Cutting heights adjustable manually. Variable speed and stop controls.

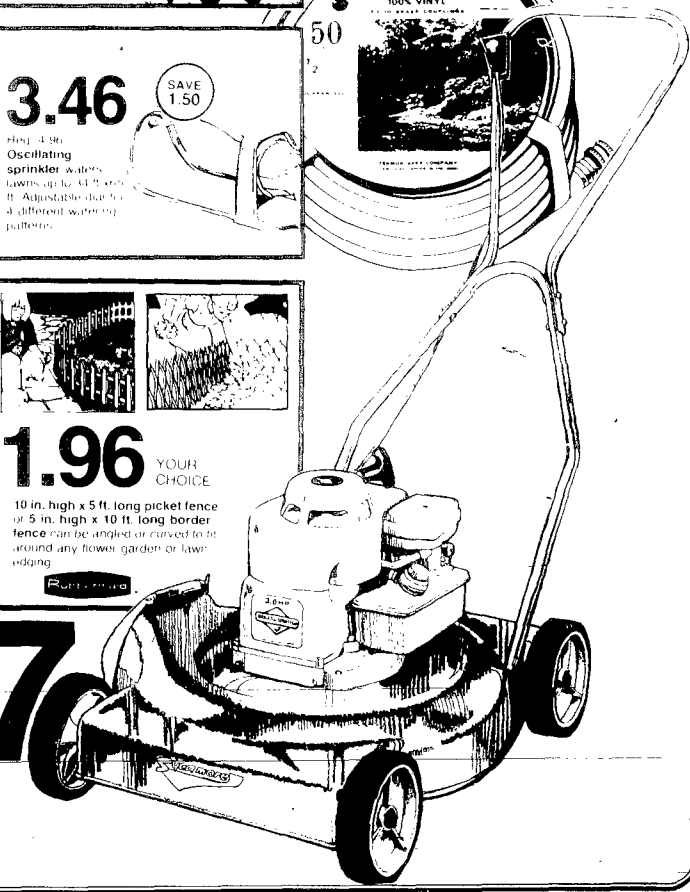



**Watches 50th Reunion**

CHRIS TIETGEN (right), Wayne, watches his 50th Old Settlers Reunion parade at Winside Sunday. With him are (left to right) his wife, Clarence Johnson, Stanton; Mrs. Edgar Marotz and Edgar Marotz; Winside.



**A Spin of the Wheel**

TAKING A spin of a wheel of chance is Amy Koekne as her dad, Bernie, looks on. They attended the Old Settlers Reunion at Winside and are from Lincoln.

## DIXON NEWS / Mrs. Dudley Blatchford 584-2588

### WCTU Visiting Hillcrest Center

Friendship Womens Christian Temperance Union will meet June 19 at 2:30 p.m. at the Hillcrest Care Center in Laurel. Members are asked to bring sandwiches, cookies or bars.

**Anniversary**  
The Garold Jewells, the Robert Patelfields and the Frank Pfluegers and daughters were June 3 evening guests in the Aljo Patelfield home in honor of the hosts' wedding anniversary. Jewells visited in the Randy Patelfield home June 5.

**Logan Center**  
United Methodist Church, (James Mote, pastor)  
Sunday: Worship, 8:30 a.m.; Sunday school, 9:30.

**Dixon United Methodist Church**  
(Vivian Hand, pastor)  
Sunday: Worship, 8:30 a.m.; Sunday school, 9:30.

**St. Anne's Catholic Church**  
(Jerome Spenser, pastor)  
Sunday: Mass, 8 a.m.

The Sterling Borgs visited Alice Chambers June 3 at the Clarkson Memorial Hospital in Omaha and in the Dr. Aaron Armfield home. Alice Chambers

was dismissed last week from Clarkson Hospital and is recuperating in the Dr. Aaron Armfield home, Omaha. Borgs also were guests in the Dan Cox home, Omaha.

**Over 50 Club**  
Sixteen were present Friday at St. Anne's Parish Hall for the Over 50 Club meeting. The afternoon was spent playing cards. Beginning June 22, meetings will be held in the evening at 7:30.

Mrs. John Humphrey, David and Brian, Olney, Ill., and Mrs. Paul Thomas were June 4 afternoon guests of Elsie Patton. The Ernest Knoelis, the Ray Fitches and Donna, Leavenworth, Kan., returned Friday from a two week trip visiting relatives in Caldwell and Boise, Idaho and sightseeing in Yellowstone National Park and the Black Hills.

The David Schufftes, the Martin Bosses, Amanda and Marie Schuffte, the Walter Schufftes and Mrs. Dick Polleson, Hubbard, were Sunday supper guests in the Bill Schutt home. The Walter Rewinkles, Orangevale, Calif., were June 5

guests in the Clayton Stingley home. The Mike Schultzes, Randy Stingley, Norfolk, Shirley Brochhaus, Madison, the Duane Stingleys and Travis were also evening guests.

The Arvin Noes, Downs, Ill., and the Oliver Noes were June 4 evening guests in the Leslie Noe home. Mrs. Ray Dickey was a June 6 afternoon guest.

The Laurence Foxes were Sunday dinner guests in the Gary Fox home, Hawarden. The Jim McIntyrs, Long Beach, Calif., were weekend guests in the Leroy Creamer home.

Saturday supper guests in the Don Peters home were the John McDaniels, Gering, Louise Henschke, George Eickhoff, the Larry Lindahls and Brian and Michael.

The Austin Gohlbers attended the Tramp reunion at Menominee Sunday.

The Laurence Webers, Mead, were Saturday overnight guests in the Harriet Frahm home. The Kenneth Kardells and Daniel spent the weekend helping Dudley move into his house at Funk, and were also guests of Mrs. Nina Anderson at Holdrege.

**NOW OPEN**

**Superior  
Speed Wash**

**9th and Main**

## CONCORD NEWS / Mrs. Art Johnson 584-2495

### Club Meets With Mary Johnson

The Bon Tempo Bridge Club met June 6 with Mary Johnson. High scores went to Delores Koch and Mae Rueter. The next meeting will be June 19 at Helen Pearsons.

The Norman Andersons took part in the 44th annual convention of the Nebraska Chapter of the National Association of Postmasters at Columbus recently. Nearly 200 postmasters attended.

The Clifford Fredricksons returned home June 7 from Minnesota, where they visited the Ted Petersons at Sturgeon Lake and Mrs. Bessie Johnson, who is recuperating after a three week stay in the hospital. On June 2 they attended an open house at the Arthur E. Johnsons, Chaska, Minn., in honor of seven high school and college graduates.

**St. Paul's Lutheran Church**  
(Frederick Cook, pastor)  
Sunday: Worship, 8:30 a.m.; Sunday school and confirmation class, 9:30.

**Concordia Lutheran Church**  
(David Newman, pastor)  
Sunday: Sunday school and Bible classes, 9:30 a.m.; worship, 10:45.

**Evangelical Free Church**  
(John Westerholm, pastor)  
Thursday: WMS will meet at 2 p.m. at the Hillcrest Care Center in Laurel, quarterly business meeting, 8 p.m.  
Sunday: Sunday school, 10 a.m.; worship, 11; evening service, 7:30 p.m.  
Wednesday: FCYF meets, 8 p.m.

**Circles Meet**  
Hannah Circle of the Lutheran

Church met with Nina Carlson last week with 10 members. Lucille Olson gave the Bible study. Next month the group will meet with Bertha Vollers.

Rebekah Circle met with Joyce Johnson. Lynelle Krie presented the Bible study for the eight members attending. The Circle plans to visit the Wakefield Health Care Center next month.

Eight members of Sarah Circle met in the home of Ester Peterson. The Bible study was given by Margaret Anderson. Blanche Pearson will be the July hostess.

Lydia Circle is planning to visit the Hillcrest Care Center in Laurel this Saturday.

**Thought for Today**

By Rowan Wiltse

Father... count on him for love, affection, understanding, friendship, comfort, help, attention, cheer, kindness, courage, fun, leadership, wisdom and honesty.  
Fathers are very special... honor him this week and all through the year.  
Happy Father's Day.

**Wiltse Mortuaries**

Wayne, Laurel & Winside

## Putt It In For Dad For Father's Day!

Win Something for Dad in Wayne  
This Saturday in the  
**Free Putt It In Contest!**



- »» **LOCATION:** on the sidewalk at 213 Main
- »» **TIME:** 10:00 a.m. to 2:00 p.m.
- »» **PRIZES:** Gift and Discount Certificates, while they last, from participating Chamber Merchants.

### Official Rules

1. Anyone can try!
2. Three chances per entrant for hole in one.
3. Putters available, or bring your own.
4. Free golf "troubleshooter guide" per entrant, while they last.
5. A "hole in one" winner gets a discount or gift certificate for dad while they last, so hurry on down and putt it in for dad in Wayne.

Sponsored by the Retail Committee of the  
**Wayne Chamber of Commerce.**

# MONEY MARKET CERTIFICATES

# 9.047%\*

\* Federal law and regulation prohibit the payment of a time deposit prior to maturity unless 3 months of the interest thereon is forfeited and interest on the amount withdrawn is reduced to the passbook rate. Federal law also prohibits the compounding of interest.



**First National Bank of Wayne**  
301 Main Street Phone 375-2525  
Member F.D.I.C.

# RAMIDA

**9.96**

3 in 1 fishing chair



SAVE 1.92



**9.96**

Wisconsin price 10.30

Reg. 11.97. Igloo Playmate cooler. 10 quart. 12 x 12 x 14. Made of heavy-duty polyethylene. Made in U.S.A.

SAVE 2.01



**29.96**

5 gallon wet-dry shop vac

SAVE 6.00

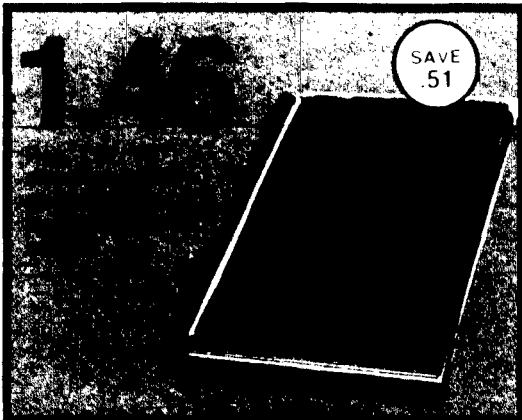

SAVE .51



**29.96**

SAVE 8.00

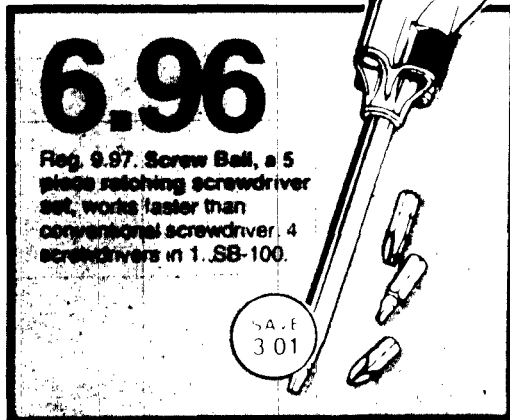

**6.96**

Reg. 9.97. Screw Ball, a 5 piece ratcheting screwdriver set, works faster than conventional screwdriver. 4 screwdrivers in 1. SB-100.

SAVE 3.01

**SALE PRICES GOOD THROUGH SUNDAY, JUNE 17!**



**2**  
For **7.00**

**Fruit of the Loom T-shirts and briefs.** Made of 100% cotton in white only. Now specially priced during our Vacation Sale



**6.88**

**Dickie work shirt for men** of heavy weight polyester/cotton. Permanent press with soil release finish. Mix or match with Dickie work pants.

**7.88**

**Dickie work pants** feature easy alter waistband with proportioned cut for more comfort and better fit.

**2.00**

**Fruit of the Loom pocket polo** for men in colors: navy, brown, green, royal or yellow



**FRUIT OF THE LOOM**

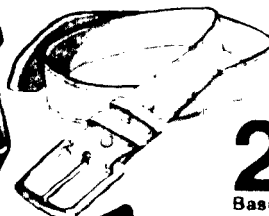

**2.00**

**Basic men's belt** in assorted colors and sizes.

SAVE  
.78

**4.88**

Req. 5-66 **Men's buckskin work glove** with buckskin palms and suede backs.



**10.00**

**8 in. vinyl work boot** with full cushion insole and neoprene crepe sole and heel. Fully insulated.

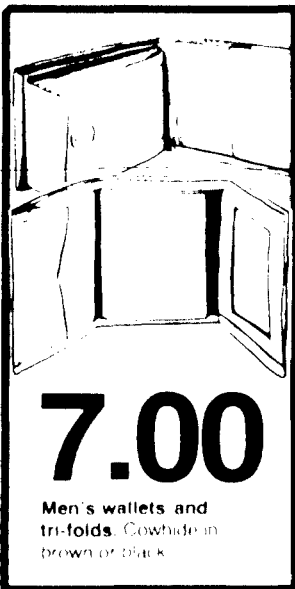

**7.00**

Men's wallets and tri-folds. Cowhide in brown or black.



**.77**

Men's dress socks of Orlon® acrylic. 8 ply. 10 to 13.

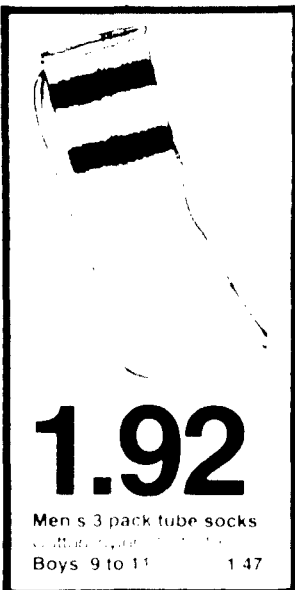

**1.92**

Men's 3 pack tube socks. Cotton. Regular fit. Boys 9 to 11. 1.47

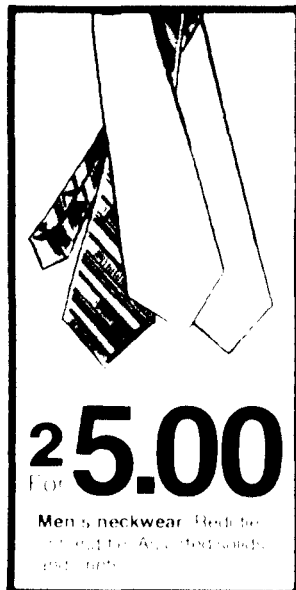

**25.00**

Men's neckwear. Ready to wear. 40% off. 15.00. 1.47

**28.00 7.44**

For Men's short sleeve collar and placket knit shirts. Sizes S, M, XL. Or choose men's short sleeve dress shirts, 14" to 17"

Men's long sleeve western shirt with snap front, snap cuffs, front and back yokes in woven cotton/polyester. Permanent press. Plaid only.

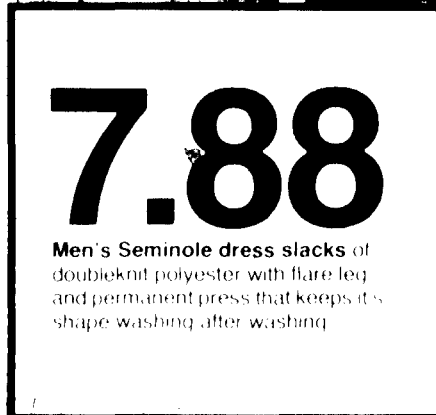

**7.88**

Men's Seminole dress slacks of doubleknit polyester with flare leg and permanent press that keeps its shape washing after washing.

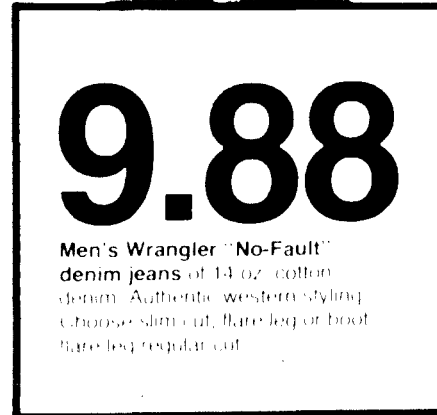

**9.88**

Men's Wrangler "No-Fault" denim jeans of 14 oz. cotton denim. Authentic western styling. Choose slim cut, flare leg or boot flare leg regular cut.

**SAVING COUPON**

**20% OFF**

(WITH COUPON)

ALL TIMEX WATCHES!  
REG. PRICE WITHOUT  
COUPON  
COUPON EXPIRES SUN.,  
JUNE 17.

FOR STORE USE ONLY  
REG. PRICE  
20% OFF  
PURCHASE PRICE

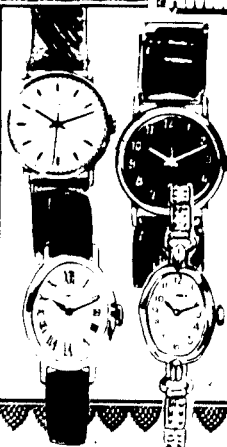

# 19.96

Reg. 25.97. **Black & Decker** 7 1/4 in. circular saw with 1 1/2 h.p. motor. Sturdy steel wrap around shoe for added support. Power lock-off button. 7308.

Wisconsin Price 28.94

**Black & Decker.**

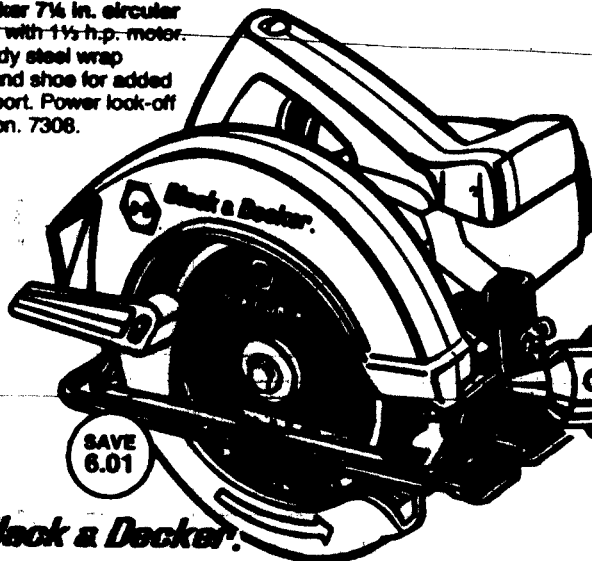

# 7.96

Wisconsin Price 8.97

Reg. 10.97. **Black & Decker** 7504 jig saw makes straight, curved and scroll cuts on wood, metal, plastics and other material. Double insulated.

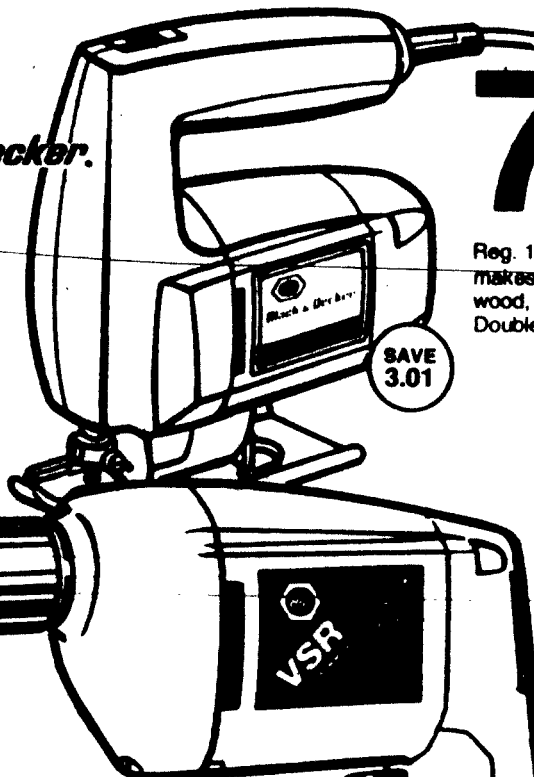

# 12.96

Wisconsin Price 13.99

Reg. 16.97. **Black & Decker** 3/8 in. VSR drill. Acceleration trigger lets you pick the speed to suit the job. Reversing switch for removing screws, nuts, and jammed drill bits. 7127.

**Black & Decker.**

# 12.96

40 pc. combination 1/4 in. and 3/8 in. drive socket set. Both inch and metric.

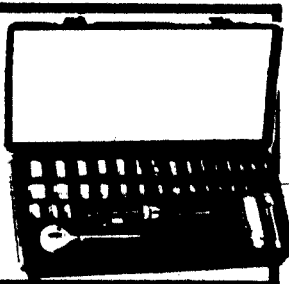

**Father's Day**  
June 17



SAVE 4.01

**Black & Decker.**

# 6.96

Reg. 9.57. Vise-grip gift set includes 2 sizes of vise grip locking pliers.

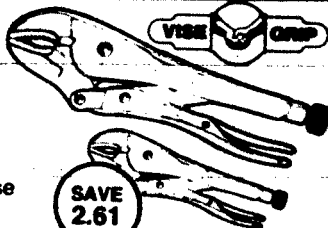

# 9.96

Reg. 14.97. 11 pc. combination end wrench set. Triple chrome plated. Super buy!

SAVE 5.01



# 18.96

Reg. 24.97. 2 drawer tool chest AA-240. An ideal size recommended for the average home owner. Drawers provide good tool separation and eliminates digging to find what you want. Automatically locks when the cover is closed.

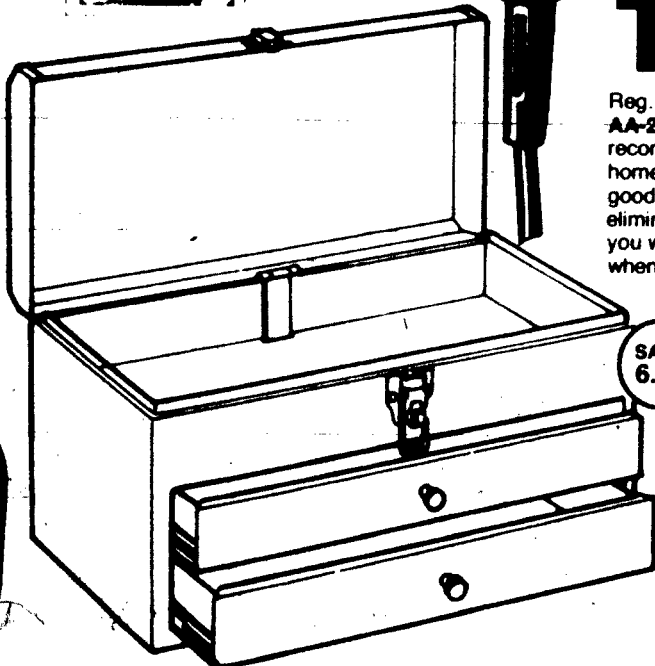

SAVE 6.01

# 4.96

Reg. 6.77. **Pamida wall paint** in gallons. White and assorted colors. Is easy to apply, quick drying, and 1 coat coverage on most surfaces. Soap and water clean-up.

SAVE  
1.81

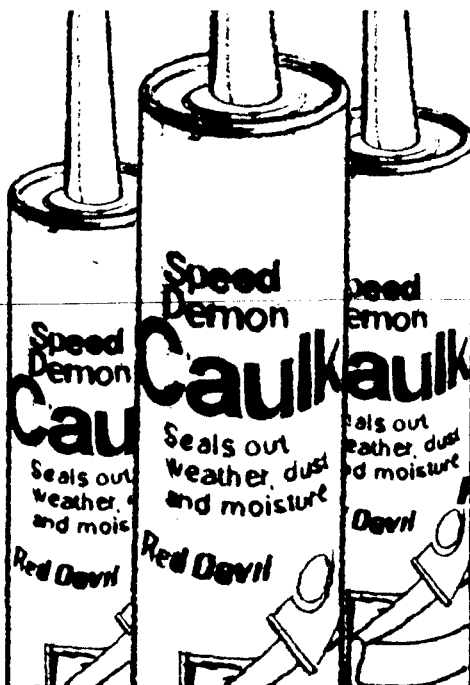
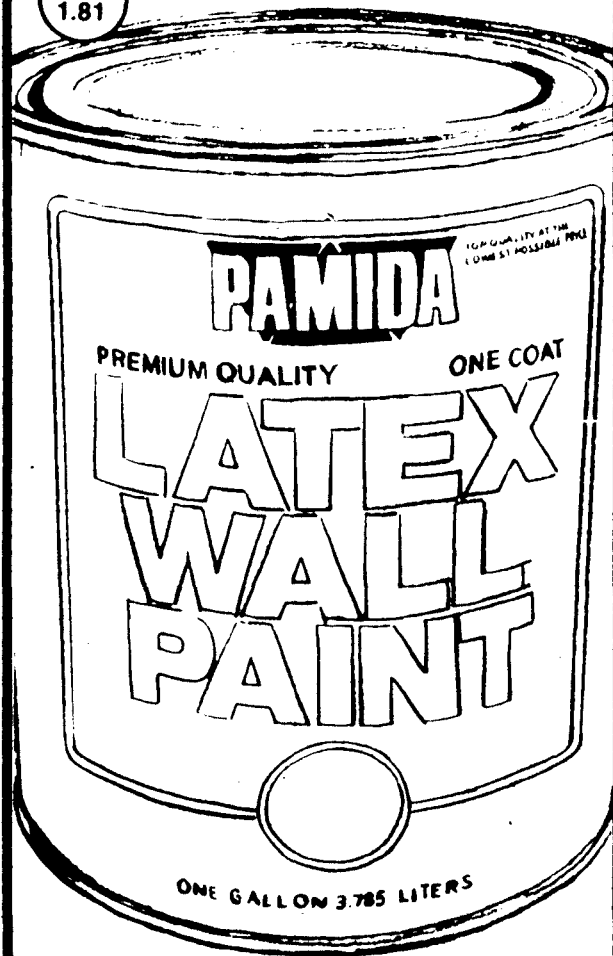

# 3 For 1.00

**Red Devil oil base caulk.** Economical, all-purpose caulk. Seals out weather, dust and moisture

# 2 PKGS.

# .96

**Pamida AA heavy duty batteries,** 4 to a package. Use for calculators, radios and more.



# .66

**Pamida 9 volt heavy duty batteries,** 2 pack. Many household uses. Great buy!

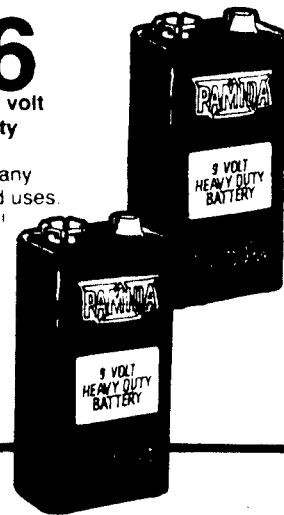

SAVE  
2.01



# 6.96

Reg. 8.97. **Interior, exterior Pamida paint** that comes in a 2 gallon pail. **White latex** applies easily. Dries to a flat finish with good durability. Recommended for ceilings.

**.39** Ea.

Plastic ketchup or mustard dispenser, 7½ in. tall. Cap assures no-leak squeezing.

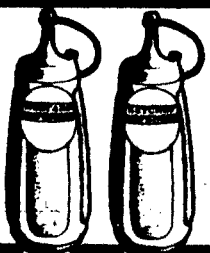

**.69**

Walmart Price .75  
48 oz. Sani-Flush removes stains. Disinfects as it cleans.

**.79**

32 oz. Windex refill, with ammonia D.

**1.37**

Walmart Price 1.40  
16 oz. Raid Ant and Roach Killer has a penetrating vapor.

**.79**

Walmart Price .91  
Northern bath tissue, 4 roll pack. White and assorted colors.

**.64**

Aluminum ice-cream scoop with high-impact plastic handles.

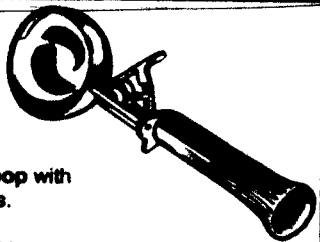

**.39**

Mickey Mouse orange sipper with tight, non-spill cap. Unbreakable and dishwasher safe.



**2 1.00**

For Mickey Mouse happy straws can't break and are easy to clean.



**.24**

Fly swatter of polyethylene, handles of rugged white styrene. Many colors.



**.39**

Corn skewers with stainless steel prongs. Set of 6. No more burned fingers!

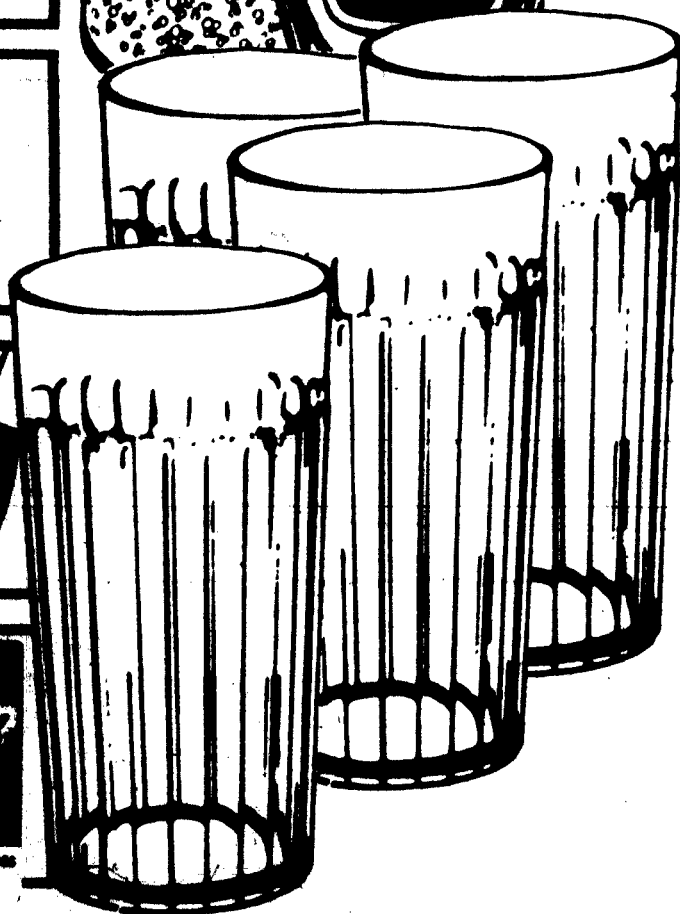
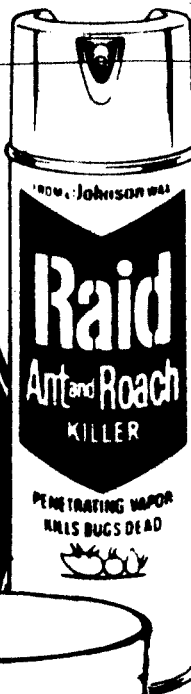

**4 .88**

For 10 ounce clear plastic tumblers are break resistant and top rack dishwasher safe. Molded of stain resistant, non-clouding acrylonitrile with built-in stacking lugs that prevent sticking.



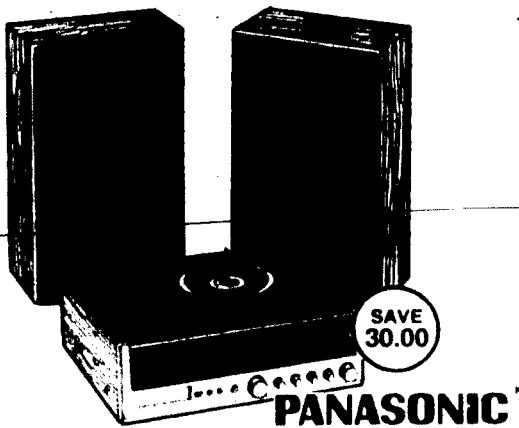

SAVE  
30.00

PANASONIC

229.96

Reg. 259.96. Panasonic AM/FM stereo radio with built-in 8 track player/recorder and automatic record changer, headphones and speakers all in simulated wood cabinet. SE3170.

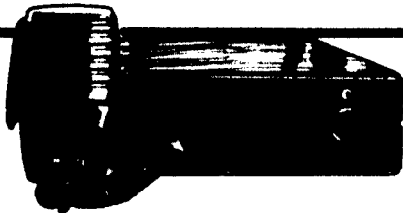

39.96

Kraco 40 channel CB transceiver. Compact size with advanced phase lock loop frequency synthesizing system and more. Magnetic or gutter mount antenna ..... 9.99



SAVE  
30.00

166.96

Reg. 196.96. Pioneer 8-track AM/FM stereo receiver deck with BSR changer and speakers. Phase locked looped multiplex demodulator and much more. UTH3311.

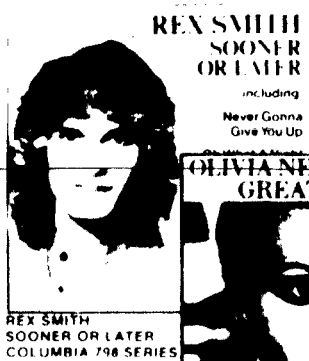

REX SMITH  
SOONER OR LATER  
COLUMBIA 798 SERIES



OLIVIA NEWTON JOHN'S  
GREATEST HITS  
MCA 798 SERIES

TOTALLY HOT



OLIVIA NEWTON JOHN TOTALLY HOT  
MCA 798 SERIES



BARBARA MANDRELL  
BEST OF  
BARBARA MANDRELL  
ABC MCA 798 SERIES

PICTURED ITEMS ONLY

4.96

STEREO LP

4.96

TAPE

JAMES TAYLOR  
FLAG

including  
Up On The Roof/Company Men  
Johnnie Comes Back/Day Tripper  
Brother Truckee/Waterworks



JAMES TAYLOR FLAG  
COLUMBIA 898 SERIES

PICTURED ITEM ONLY

5.96

STEREO LP

5.96

TAPE

ORIGINAL SOUNDTRACK RECORDING  
HAIR



SOUNDTRACK HAIR  
RCA VICTOP 1498 SERIES

PICTURED ITEM ONLY

11.96

STEREO LP

11.96

TAPE

DONNA SUMMER  
Bad Girls



DONNA SUMMER BAD GIRL  
CASABLANCA 1398 SERIES

PICTURED ITEM ONLY

10.96

STEREO LP

10.96

TAPE

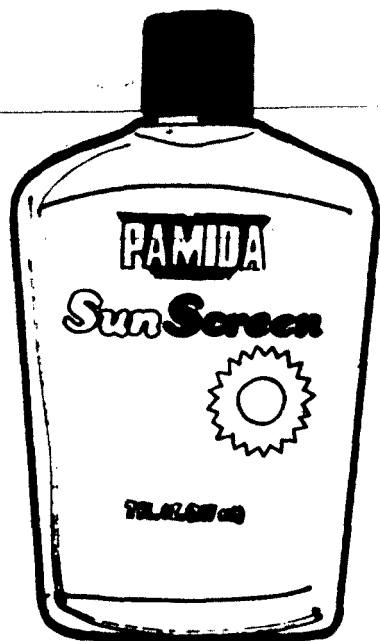

**1.46**

Pamida Sunscreen 7 oz. for maximum protection for sun sensitive skin.



**1.28** Ea.

- Cover Girl thick lash mascara.
- Wella Balm instant conditioner, 16 oz. regular or extra body.
- Prell Liquid Shampoo, 11 oz.
- Prell concentrate shampoo, 5 oz.
- Noxzema Skin Cream, 6 oz.



**.96** Ea.

- Pamida Hawaiian Lotion, 8 oz.
- Pamida Hawaiian Lotion, 8 oz.
- Pamida Suntan Lotion, 8 oz. with cocoa butter.

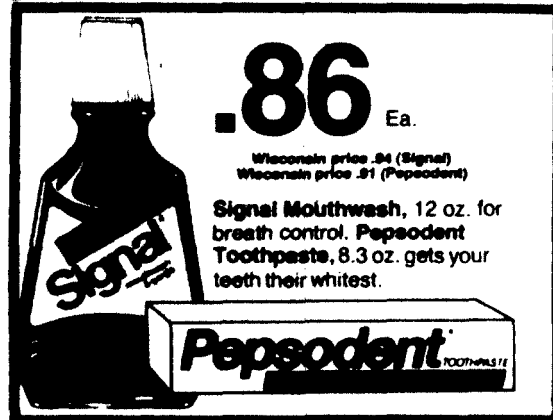

**.86** Ea.

Wholesale price .84 (Signal)  
Wholesale price .81 (Pepsodent)

Signal Mouthwash, 12 oz. for breath control. Pepsodent Toothpaste, 8.3 oz. gets your teeth their whitest.



**11.96**

Norelco Gotcha Gun 1000 dryer with compact pistol grip. Only 7 in. long, extra light and spot attachment included. For guys and gals.

Norelco®

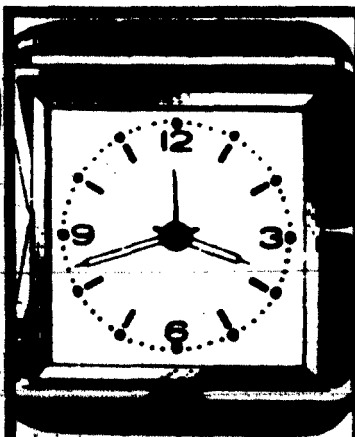

**3.96**

Reg. 4.97. Sunrise travel alarm. It's convenient, compact and lightweight. Super for the man or woman on the go!

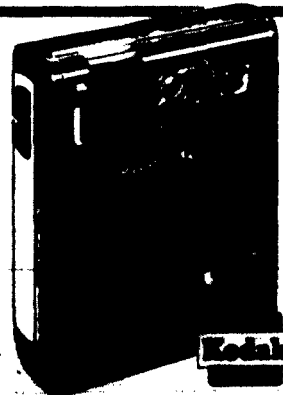

**29.96**

Reg. 32.96. Kodak Colorburst 80 instant camera has fixed focus lens, motorized print ejection, attractive styling, all at a popular price.  
PR10 Instant Film ..... 5.46



**1.76** 12 Exp. Roll

PHOTO FINISHING AND DEVELOPING

20 exp. roll ..... 2.76  
24 exp. roll, 35mm ..... 3.46  
20 exp. slides or Super 8 mm movies ..... 76

# 66.00

Reg. 74.97. **Huffy Thunder Trail** has a silver finish hard tail frame designed for strength, large pedals, single speed and coaster brakes. 20 in. HP82.

SAVE  
8.97

**HUFFY**

**WENZEL**

SAVE  
5.01

# 19.96

Reg. 24.97. **Wenzel 3 lb. hollofil 808 sleeping bag.** Rust outer with attractive plaid cotton flannel lining. Double weather stripped and tie strings for bundling. Model 44051

SAVE  
5.00

**Coleman**

# 24.97

Reg. 29.97 **Coleman 12 gallon cooler and 1 gallon jug** of poly-lite, sturdy plastic. Food stains and odors will not remain. Model 5286-756

# 46.96

Reg. 54.97 **Marlin Glenfield semi-automatic rifle** with scope Model 60. 22 caliber, 18 shot magazine. Walnut finished hardwood

SAVE  
8.01

**FIREARMS NOTICE**  
We sell guns for the sportsman in strict compliance with all Federal, State and Local regulations.

**Marlin**

SAVE  
5.09

SAVE  
1.09

**WENZEL**

# 14.88

Reg. 15.97 **Propane 2 mantel lantern** with 16.4 oz. propane cylinder. 29264

# 29.88

Reg. 34.97 **Wenzel 2 burner camp stove.** Has wind screens and baked enamel finish. 29260

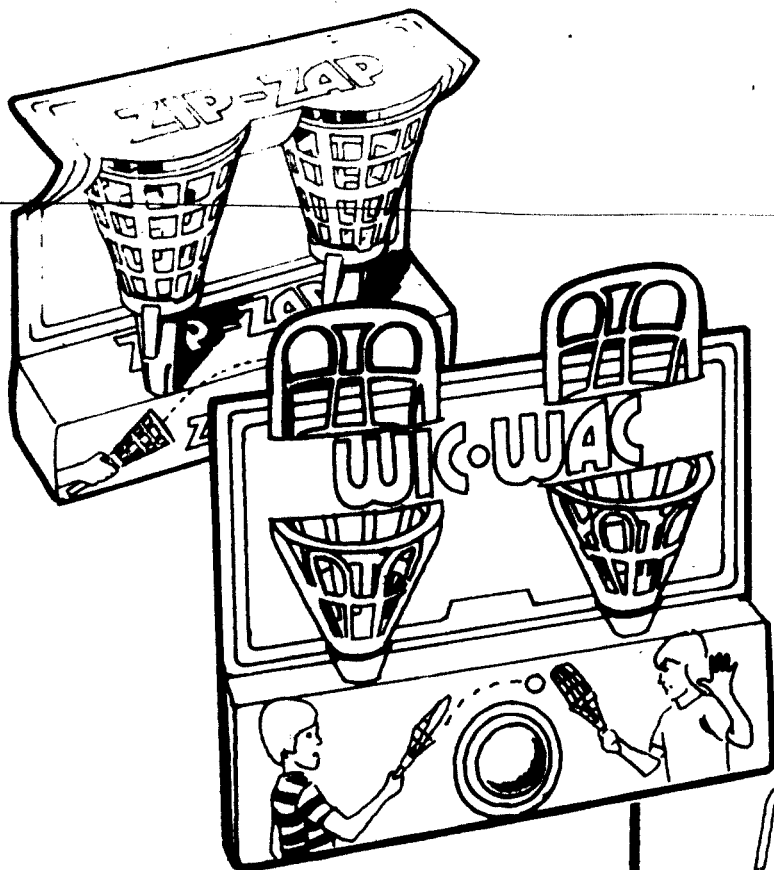

**1.36** Ea.

Zip-Zap or Wic-Wac, two exciting toss and catch games from Empire. 4310 Zip-Zap has a trigger that automatically "pops" the ball into the air. Wic-Wac, 4480, has a special cage to help catch the ball. Ages 4 and up.

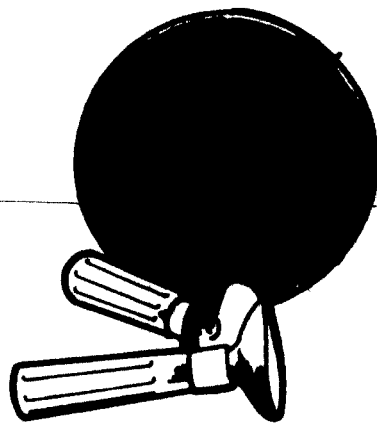

**2.96**

Krazy Katch, the amazing new way to toss and catch. Each includes two vacuum handles. Special Krazy Katch® ball, and easy directions. For indoors or outdoors. Fun for the whole family.

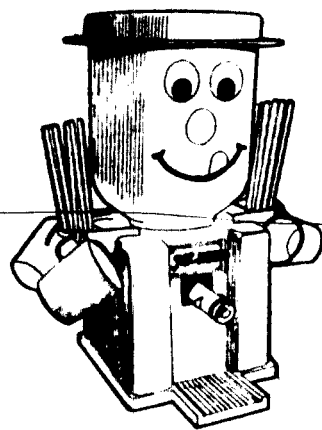

**2.96**

Mr. Kool Beverage Dispenser. There's cups, straws, holders and a serving tray. Mr. Kool dispenses your favorite beverage. For ages 3 and up. Durable and long lasting. Model 3077.

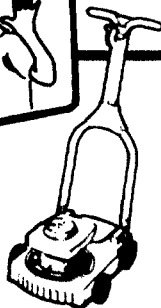

**1.76**

Lawn mower for kids that makes a real mower sound as you push it. Great gift for the little helper. No. 2380.



**2 5.00**

For Doodle cards are especially great for keeping children busy while traveling. Each contains 4 cards and 5 felt tip pens. 4 different subjects on 5x7 cards.



**2 1.00**

For Assorted comic books by Whitman. All the latest from Disney cartoons to your favorite super heroes.



**2 For 1.00**

Nut logs or dry roasted peanuts. Salted in the shell. Delicious for snack time, anytime. Or choose assorted Queen Anne nut logs. Cashew, pecan or peanut flavors.

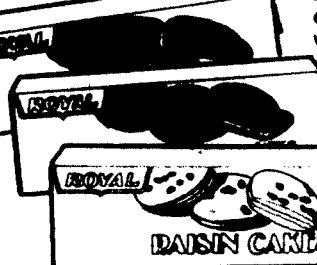

**.69** Ea.

Oatmeal cookies, raisin cakes, or devil's food cakes. These delicious snacks are creme filled and individually wrapped, 10 to each box, your entire family will love them.

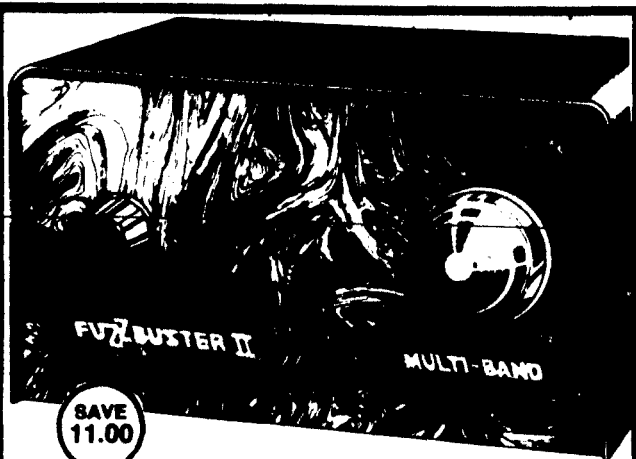

SAVE  
11.00

**FUZZBUSTER II**

**88.00**

Reg. 99.00. **Fuzzbuster 11 radar detector.** Multi-band detector untraps the radar for you.

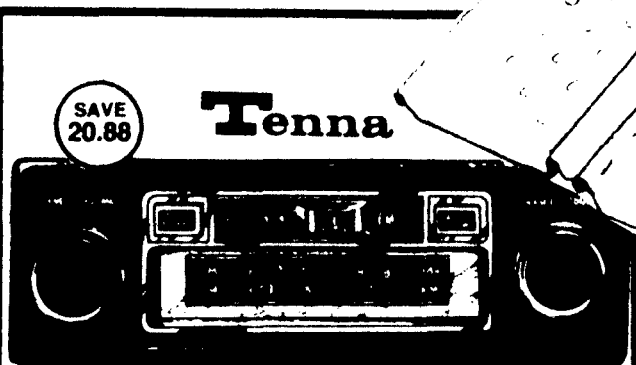

SAVE  
20.88

**Tenna**

**79.00**

Reg. 99.88. **Tenna AM/FM 8-track in-dash stereo** features patented fine tuning from the front of the 8-track, illuminated program indicators, tone-volume-balance control, bass boost, mono-stereo switch, automatic frequency control and more. Model RR2014MPX.

**59.88**

Reg. 69.88. **1½ ton hydraulic floor jack** has lifting range from 5 to 15 in. with special construction to eliminate off center load. Ball bearing swivel casters for easy positioning. Heavy duty design with 360 degree swivel.

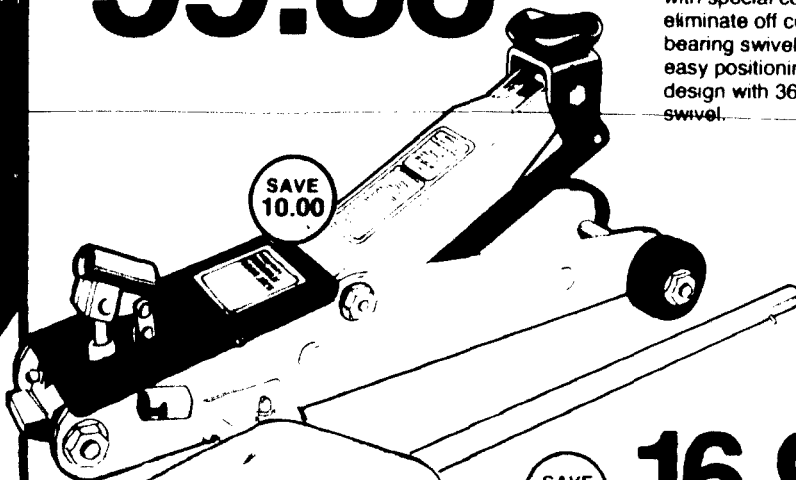

SAVE  
10.00

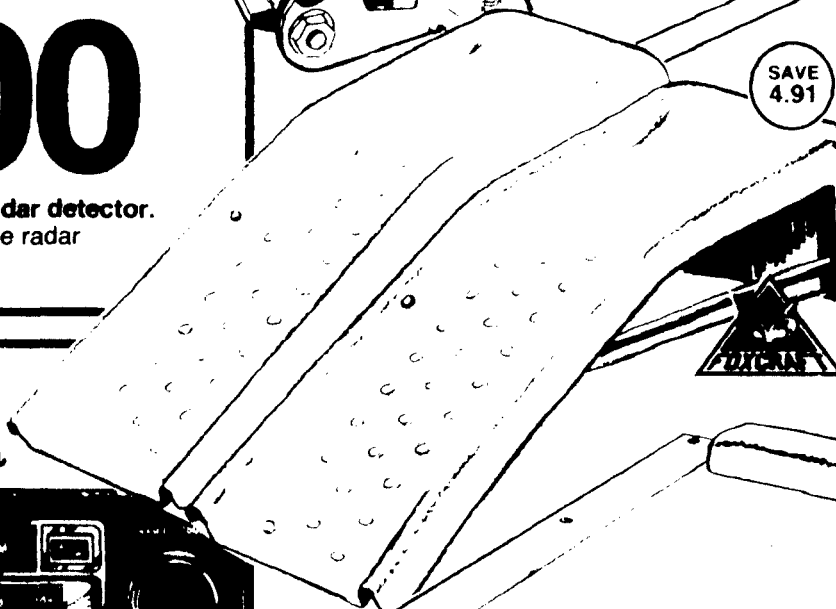

SAVE  
4.91

**16.97** A  
Pair

Reg. 21.88 pair. **Foxcraft car ramps.** One piece heavy gauge steel construction. Slip-resistant incline and positive wheel stop. Lightweight and portable for easy storage.

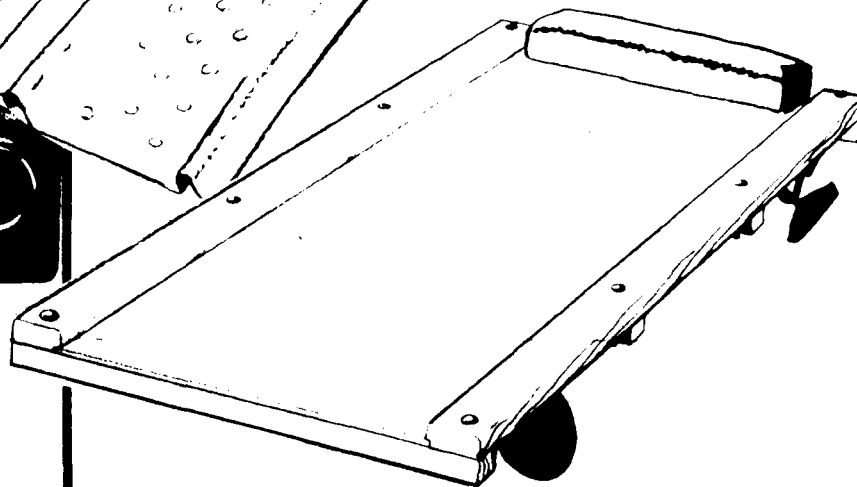

**6.88**

Wisconsin Price 6.94

**Wooden auto creeper.** Sturdy hardwood with 4 cross bars. Padded headrest. Big 2¾ in. nylon wheels.

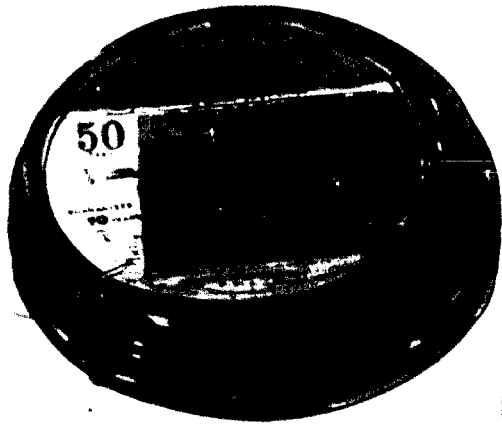

**3.97**

5/8 in., 50 ft. garden hose is 100% polyethylene reinforced. Solid brass coupling is fully guaranteed for material and workmanship.

# RAMIDA Vacation Sale



SAVE  
2.00

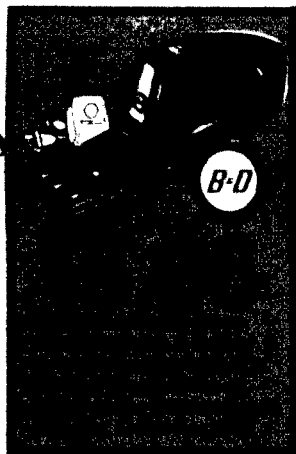

B-D

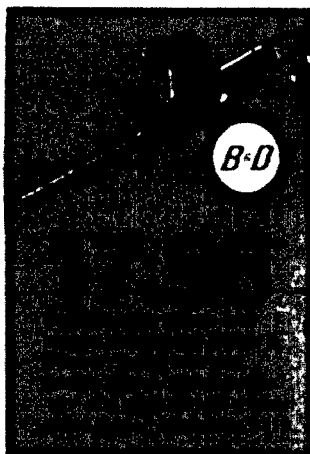

B-D

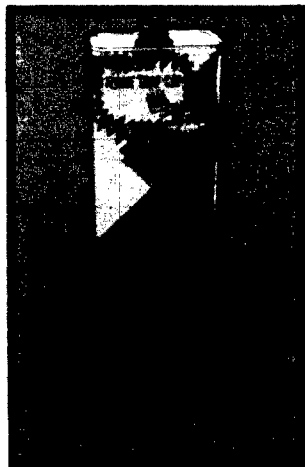

SAVE  
10.00

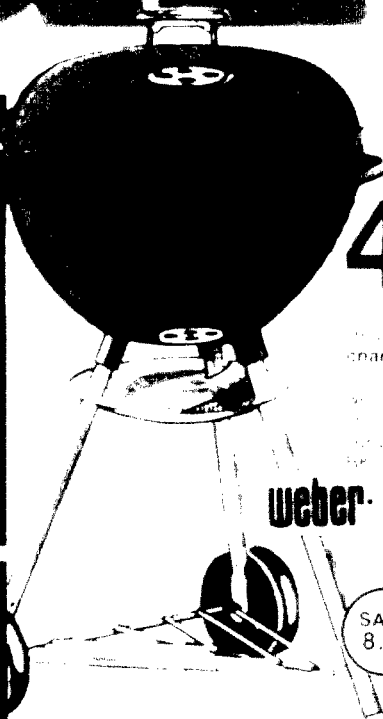
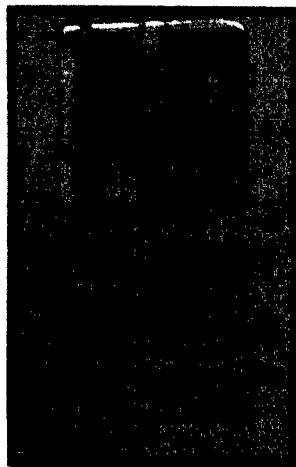

**49.99**

Wisconsin price \$2.31

22" in. Weber charcoal grill. Features a heavy-duty cast iron body, a stainless steel lid, and a stainless steel tripod stand. The grill is designed for easy use and long life.

weber.

SAVE  
8.95

PLAN II Advertising Supplement to  
ILLINOIS  
KANSAS  
MINNESOTA  
MONTANA  
NEBRASKA  
SOUTH DAKOTA  
WISCONSIN  
WYOMING

IN THE EVENT THE ADVERTISED MERCHANDISE IS NOT AVAILABLE DUE TO UNFORESEEN REASONS, RAMIDA WILL ISSUE A RAIN CHECK UPON REQUEST OR WILL SELL YOU A COMPARABLE ITEM AT A COMPARABLE DISCOUNT. IT IS RAMIDA'S POLICY TO BE PRICED COMPETITIVELY IN THE MARKET. REGULAR PRICES MAY VARY MARKET-BY-MARKET, BUT THE SALE PRICE WILL ALWAYS BE AS ADVERTISED. WE RESERVE THE RIGHT TO LIMIT QUANTITIES, EXCEPT WHERE PROHIBITED BY LAW.



WESTERN AUTO

EVERY ITEM ON THIS PAGE

# 25% OFF

SALE ENDS  
JUNE 23rd



Gold,  
Brown or Oxblood Vinyl  
REG. 179.99! RECLINER

## 99<sup>99</sup>



Save  
\$100

POWERFUL  
COOLING

## 289<sup>99</sup>

Regular 389.99  
10,350 BTU  
115 volts Thermostat  
Exhaust ports  
removes odors

EVERY AIR CONDITIONER ON  
SALE...SEE PAGE 31



PLASTIC  
TACKLE  
BOX

Regular  
1.39

## 104



Reg. 2.79

9" ROLLER  
AND TRAY

## 149

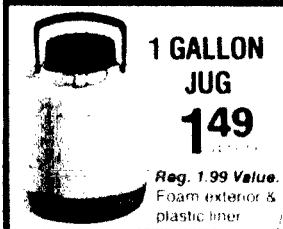

1 GALLON  
JUG

## 149

Reg. 1.99 Value.  
Foam exterior &  
plastic liner



16 OUNCE  
TUMBLER

Reg.  
44c 

## 33<sup>c</sup>

Pretty Colonial  
style tumblers  
Buy several now!



BADMINTON AND  
VOLLEYBALL

## 969



FUN SLIDE POOL 

## 1235

Regular 18.49 Value! Vinyl



Use your convenient Western  
Auto charge account. Visa or  
Master Charge card at many  
Western Auto stores when you  
buy W.A. sale items.



Save  
\$10!

Oscillating

12" 3 SPEED FAN

Reg. 38.99!  
Cool & quiet.

## 2899



30 GAL. CAN

Regular  
12.99  
Value

## 888

Tough polypropylene trash  
can resists cracking

# RADIALS... →

# Save up to 9<sup>00</sup> PER TIRE

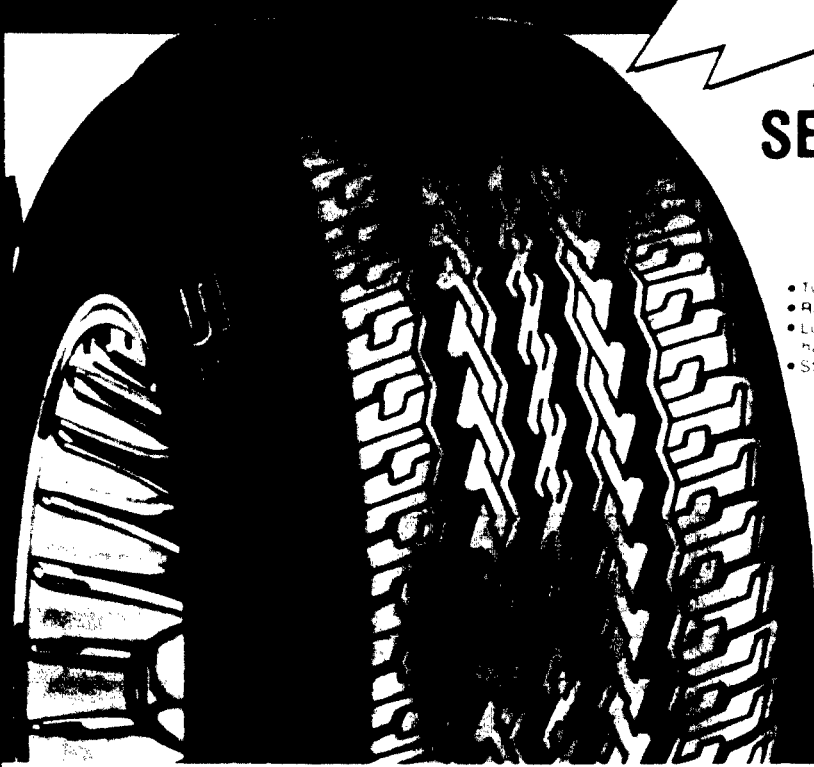

## SENTRY RADIALS

LOW AS... **26<sup>88</sup>** EACH AT THE ABOVE PRICE PER TIRE

- Two tough fiberglass belts stand up to impacts
- Radial plies work for maximum tread to road contact
- Long wearing tread compound delivers improved handling and mileage
- Step up to radial performance at these low prices

### Sentry Radial Blackwall Tubeless

Size	Stock Number	Reg. Each	Sale Each	F E T Ea. Tire
165R-13	16-6530-6	34.88	<b>26.88</b>	1.82
185R-15	16-6540-5	34.88	<b>31.88</b>	2.03

### Sentry Radial Whitewall Tubeless

Size	Stock Number	Reg. Each	Sale Each	F E T Ea. Tire
AR78-13	16-6600-7	37.88	<b>29.88</b>	1.70
BR78-13	16-6601-9	42.00	<b>33.88</b>	1.94
DR78-14	16-6602-3	44.88	<b>38.88</b>	2.07
ER78-14	16-6603-1	46.88	<b>41.88</b>	2.14
FR78-14	16-6604-9	49.88	<b>45.88</b>	2.35
GR78-14	16-6605-6	53.88	<b>48.88</b>	2.50
HR78-14	16-6606-4	56.88	<b>51.88</b>	2.67
GR78-15	16-6615-5	53.88	<b>48.88</b>	2.50
HR78-15	16-6616-3	58.88	<b>51.88</b>	2.71
LR78-15	16-6619-7	61.88	<b>54.88</b>	3.00

# BELTED... →

# 25% OFF!

Save up to 15<sup>00</sup> Per Tire!

**MACHO BELTED WHITEWALLS** **27<sup>00</sup>** EACH AT THE ABOVE PRICE PER TIRE

- Wide 7-rib Poly-BD tread - increased traction & life
- Rugged polyester cord body, plus 2 fiberglass belts for stability and reduced tread squirm
- Reverse contour molding gives wide tread with broad road contact and less heat build-up for long tread life
- A great handling tire with that distinctive MACHO look!

### Macho Belted Whitewall Tubeless

Size	Stock Number	Reg. Each	Sale Each	F E T Ea. Tire
A78-13	16-7400-1	36.00	<b>27.00</b>	1.74
B78-13	16-7401-9	41.00	<b>30.75</b>	1.95
E78-14	16-7403-5	46.00	<b>34.50</b>	2.07
F78-14	16-7404-3	48.00	<b>36.00</b>	2.34
G78-14	16-7405-0	52.00	<b>39.00</b>	2.50
H78-14	16-7406-8	54.00	<b>40.50</b>	2.75
G78-15	16-7415-9	52.00	<b>39.00</b>	2.50
H78-15	16-7416-7	56.00	<b>42.00</b>	2.80
L78-15	16-7419-1	60.00	<b>45.00</b>	3.11

# 2ND TIRE 1/2 PRICE



WHEN YOU BUY FIRST TIRE (SAME SIZE & TYPE) AT REGULAR PRICE

**LPS III  
OUR BEST  
POLYESTER CORD  
BIAS PLY TIRE**

**14<sup>50</sup>**  
2nd Tire

When You Buy 1st Tire Now for Only 29.00

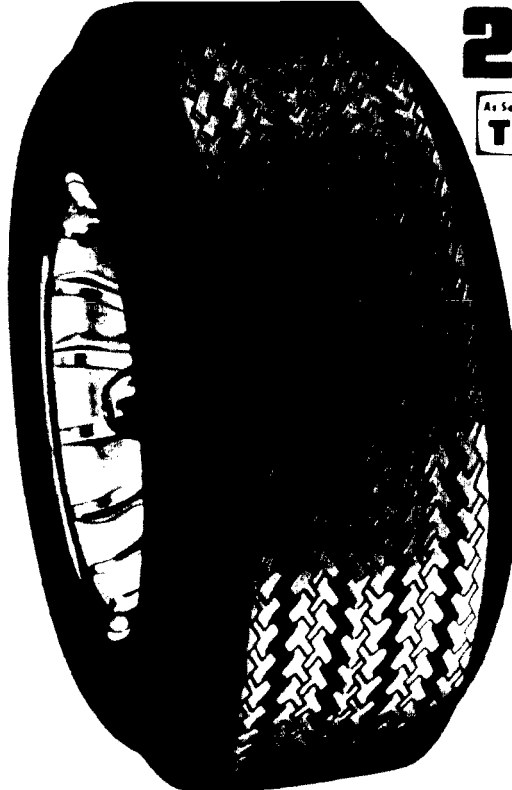

### LPS III BLACKWALL TUBELESS

Size	Stock No.	1st Tire	2nd Tire	F E T Ea. Tire
A78-13	78-13-101	24.99	14.50	14.50
6 00-15	78-15-101	24.99	16.00	16.00

### LPS III WHITEWALL TUBELESS

6 00-12	78-12-101	21.99	15.50	15.50
P155/80D-13	78-13-101	21.99	15.50	15.50
A78-13	78-13-102	24.99	17.00	17.00
B78-13	78-13-103	24.99	18.50	18.50
C78-14	78-14-101	24.99	20.00	20.00
D78-14	78-14-102	24.99	21.00	21.00
E78-14	78-14-103	24.99	22.00	22.00
F78-14	78-14-104	24.99	23.00	23.00
G78-14	78-14-105	24.99	24.00	24.00
H78-14	78-14-106	24.99	25.00	25.00
6 00-15	78-15-102	24.99	19.00	19.00
G78-15	78-15-101	24.99	24.00	24.00
H78-15	78-15-102	24.99	25.00	25.00
L78-15	78-15-103	24.99	26.00	26.00



## SANDBLASTERS

No. 1 Off the Road!

Tough on dirt and mud. Support Poly BF tread.

Size	Ply Rating	Stock No.	Price	F E T
H78-15LT	10	78-15-101	61.00	61.00
L78-15LT	10	78-15-102	65.00	65.00
L78-16LT	10	78-16-101	72.00	72.00
7 75-15LT	10	78-15-103	42.00	42.00
9 00-13	10	78-13-101	62.00	62.00
9 00-15	10	78-15-104	64.00	64.00
11-15LT	10	78-15-105	71.00	71.00
12-15LT	10	78-15-106	83.00	83.00
12-16 SLT	10	78-16-101	92.00	92.00
14 15LT	10	78-15-107	120.00	120.00
14 16 SLT	10	78-16-102	120.00	120.00

### MUD BLASTER Tube Type Blackwall

7 00 15	10	78-15-108	49.99	49.99
<b>MUD BLASTER Tubeless with Raised White Lettering</b>				
11 15	10	78-15-109	79.99	79.99

## SUPER HIGHWAY

78 Series—Pickups, Vans & Campers

Tough on dirt and mud. Support Poly BF tread.

Size	Ply Rating	Stock No.	Price	F E T
H78-15	10	78-15-110	45.99	45.99
L78-16	10	78-16-110	60.99	60.99

### Super Highway 78 Tubeless

G78-15	10	78-15-111	45.99	45.99
H78-15	10	78-15-112	50.99	50.99
8 00 16 5	10	78-16-111	55.99	55.99
8 75 16 5	10	78-16-112	65.99	65.99
9 50 16 5	10	78-16-113	69.99	69.99
10 16 5	10	78-16-114	79.99	79.99
12 16 5	10	78-16-115	89.99	89.99

## TOUGH ONE 78 RETREAD

Long Wearing Poly BD Rubber Tread

Tough on dirt and mud. Support Poly BF tread.

As low as 13.88

Size	Stock No.	Price	F E T
A78-13	78-13-110	15.88	15.88
B78-13	78-13-111	17.88	17.88
C78-14	78-14-110	18.88	18.88
E78-14	78-14-111	19.88	19.88
F78-14	78-14-112	20.88	20.88
G78-14	78-14-113	20.88	20.88
H78-14	78-14-114	23.88	23.88
H78-15	78-15-110	20.88	20.88
H78-15	78-15-111	23.88	23.88
J78-15	78-15-112	25.88	25.88
L78-15	78-15-113	26.88	26.88

PRICES AND TERMS  
OPTIONAL WITH DEALER

WESTERN AUTO 3

# OUR FINEST TIRE! Backed by our full 40,000 mile promise

SEE WARRANTY BELOW



WHITEWALL TUBELESS	STOCK NUMBER	LOW PRICE	PLUS F.E.T.
BR78-13	16-9901-6	46.88	1.90
DR78-14	16-9902-4	51.88	2.15
ER78-14	16-9903-2	59.88	2.27
FR78-14	16-9904-0	69.88	2.38
GR78-14	16-9905-7	76.88	2.57
HR78-14	16-9906-5	81.88	2.75
GR78-15	16-9915-6	76.88	2.66
HR78-15	16-9916-4	81.88	2.84
JR78-15	16-9917-2	85.88	3.01
LR78-15	16-9919-8	91.88	3.13

All prices plus Federal Excise Tax and trade-in tire

## ARAMID BELTED RADIAL TIRE WARRANTY FULL 40,000 MILE WARRANTY—DEFECT AND TREAD WEAROUT LIMITED 40,000 MILE WARRANTY—ROAD HAZARD

**FULL WARRANTY:** Aramid Belted Radial tires which fail due to defects in workmanship or materials within 40,000 miles of initial installation (18" for which the usable tread wears to a depth of 3/32" or less within 40,000 miles of initial installation) will be replaced without charge by Western Auto Supply Company. The tread wear portion of this warranty is void if tires are used commercially as implied by mechanical regulations including, but not limited to, misalignment, improper inflation or improper balancing. Tires provided as replacements under this portion of the warranty are warranted only to the extent of the unexpired portion of the warranty on the tire which is being replaced.

**LIMITED WARRANTY:** Aramid Belted Radial tires which fail due to a road hazard within 40,000 miles of initial installation will be replaced by Western Auto Supply Company, charging the customer a pro-rata amount for the number of miles service received in up to 40,000 miles. The amount of the charge will be a proportionate part of the regular selling price, not reduced sale price of the replacement tire plus the full applicable Federal Excise Tax in effect at the time of adjustment.

Western Auto load range B passenger car tires are NOT COVERED by this warranty when used on trucks or buses, including pick-up and panel trucks.

To have this warranty honored return tire to any Western Auto store with proof of installation (do not alter tread) if difficulty is encountered in having this warranty honored, contact Western Auto Supply Company, Consumer Affairs Section, General Service Department, 2107 Grand Avenue, Kansas City, Missouri 64108. This warranty gives you specific legal rights and you may also have other rights which vary from state to state.

# PERFORMANCE ON SALE!

- Broad and Brawny Design
- Quick Radial Handling Ease
- Bold Raised Outline Lettering

NOW LOW AS ...

**47<sup>20</sup>**  
Plus 2.17  
F.E.T. and  
Trade-in

BR70-13 w/white lettering

- Built for action with dual fiberglass belts to stand up to rough road impact
- Built for sure handling and control with tough polyester cord radial plies
- Built for economy with the extra tread life and mileage of radial tire design

Size	Stock No.	Regular	Sale Price	F.E.T.
BR70-13	16-4901-1	53.00	47.20	2.17
ER70-14	16-4903-7	69.00	55.20	2.83
QR70-14	16-4905-2	79.00	63.20	2.93
GR70-15	16-4915-1	82.00	65.60	2.96
HR70-15	16-4916-9	86.00	68.80	3.14
LR70-15	16-4919-3	93.00	74.40	3.52
GR60-14	16-5005-0	84.00	67.20	2.98
OR60-15	16-5015-9	86.00	68.80	3.07
LR60-15	16-5019-1	96.00	76.80	3.55

All prices plus applicable state tax and trade-in fee.



Save up to  
43.97

**MOJAVE  
WHEELS**

SET OF FOUR

**99<sup>99</sup>**

Regular 143.96 Value!

Set of 4—15x7 in. Mojave Wheels  
22-4011-10-13

155.96 Value!

**119<sup>99</sup>**

Set of 4—15x8 in. Mojave Wheels  
22-4011-10-13

163.96 Value!

**129<sup>99</sup>**

Set of 4—15x10 in. Mojave Wheels  
22-4014-1

207.96 Value!

**169<sup>99</sup>**

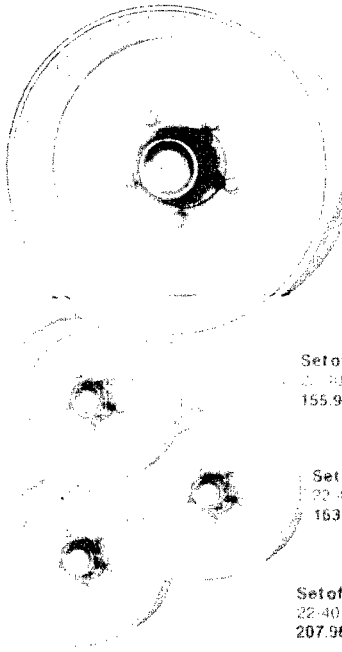

Save up to  
57.97

**WYRE/BASKET  
WHEELS**

SET OF FOUR

**149<sup>99</sup>**

Regular 189.96 Value!

Set of 4—16x8 in. Wyre/Basket  
Wheels 22-4036-39

Reg. 211.96 Value!

**159<sup>99</sup>**

Set of 4—16x7 in. Wyre/Basket  
Wheels 22-4037-39

Reg. 227.96 Value!

**169<sup>99</sup>**

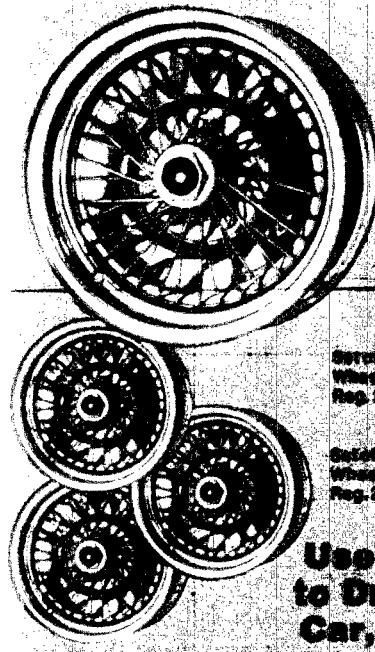

**Use Your Credit  
to Dress Up Your  
Car, Truck & RV**

WESTERN AUTO

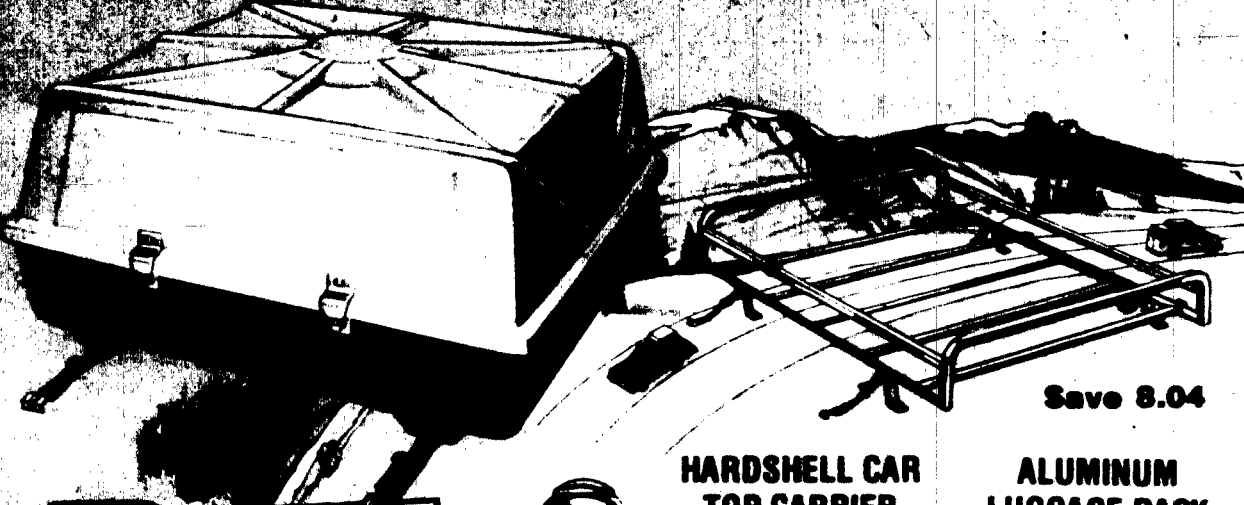

Save 8.04

**TRAILER & BOAT TIRES**

As Low As **12<sup>99</sup>**

100% nylon cord body  
Positive traction rib tread  
Withstands impact  
With tubes

4 80 4 00x8 \$12.99 - 84¢/ft.  
5 70 5 00x8 \$23.99 - 94¢/ft.  
4 80 4 00x12 \$20.99 - 89¢/ft.  
5 30 4 50x12 \$24.99 - 1 01/ft.

**HARDSHELL CAR TOP CARRIER**

Regular 64.99  
Value! **44<sup>88</sup>** 22-5215-5

15 cubic feet cargo area! Convenient, dependable way to add carrying space to your car. Hi-impact plastic. Support bars have pads. Heavy-duty straps.

**ALUMINUM LUGGAGE RACK**

Regular 27.99  
Value! **19<sup>95</sup>** 22-5205-4

Strong aluminum construction. Steel enameled. Adds that extra space you've been needing! Attaches easily to your car top. Fits most cars 42x6x54 inches.



**CHROMED CAST HITCH BALL**

Regular 4.99!  
Solid 1 1/2 in diameter ball  
Strong attachment for trailer!  
Has 3/8 inch bolt

**2<sup>99</sup>** 22-5012-5

**STICK-ON CONVEX MIRROR**

Regular 1.45!  
Necessity for towing a trailer!  
Just stick on rear-view mirror for wider field of vision

**1<sup>29</sup>** 22-1814-6

**WA** has the best Catalog ordering system in town! At most WA stores you'll know in minutes if the merchandise you want is available and when you'll receive it.

**Save 5.11**  
**PORTABLE AUTO VACUUM**



**10<sup>88</sup>**  
Reg. 15.99

- Portable! Weighs only 3 lbs.
- Plugs into car cigarette lighter
- 14 ft. of cord for maneuverability

Powerful suction—Cleans thoroughly! Comes with rug nozzle & crevice tool!

Deluxe Car Vacuum. 22-2303-0 **16.88**

Save 80c



**WHEEL COVER**

Regular 2.39  
Vinyl: Black, blue, white or woodgrain  
Cracked Velvet. 22-1115-17 **1<sup>59</sup>** 22-1121-21

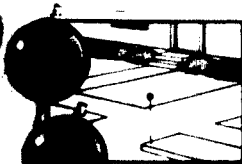

**DRIVEWAY REFLECTOR**

Reg. 1.59  
3 in dia  
Red or blue **99<sup>c</sup>** 22-2065-29



**AUTO BODY REPAIR KIT**

Regular 12.99 Value!  
Kit has everything you need to repair car's body. 11 piece set includes filler, hardener, putty and instructions.

**7<sup>99</sup>**

**DRINK HOLDER**



**19<sup>c</sup>** EACH

Spill-proof way to hold beverages while you're driving.



**AIR FRESHENER**

Pine tree shape Refreshing!  
Reg. 59c  
**39<sup>c</sup>** 22-1354-4



# WESTERN AUTO TAKES CARE OF YOURS!



## SAVE 20.00 ON A SPORTY SUN ROOF!

Bring that beautiful day right into your car with a sun roof from Western Auto! Unit fits securely into most cars and pickups. Smoke colored glass, aluminum frame. Gives your car that custom look!

**99<sup>99</sup>**  
Reg. 119.99  
15-1408-11



SAVE 1.10 NOW!  
TURTLE EXTRA  
PASTE OR LIQUID

**3<sup>49</sup>**

Reg. 4.59 Value.  
Wax Extra tough  
Extra shine



JOHNSON'S KIT WAX

Reg. 2.29 Value.  
Pre-softened for  
easy application

**1<sup>79</sup>**



RAIN DANCE CAR WAX

Reg. 4.99 Value.  
Liquid or paste. Long  
lasting Application

**3<sup>99</sup>**



SAVE 40c  
TURTLE WAX

Reg. 2.19 **1<sup>79</sup>**

Famous Turtle Wax  
is so easy to apply,  
Gives that deep  
high gloss finish.  
12 ounce

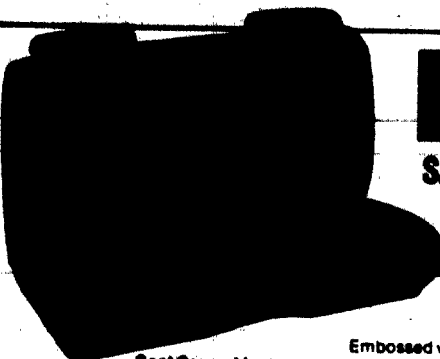

SAVE 2.00 NOW!  
SEAT COVER

Reg. 11.99 **9<sup>99</sup>**  
67-1311-18

Embossed vinyl. Front seat. Most cars  
Seat Cover. Most trucks and back seats. 67-1321-23 10.99  
Quilted Nylon Seat Cover. Front. Most cars. 67-1341-48 12.99



STAR BRITE  
CAR POLISH

Reg. 3.79 **2<sup>79</sup>**

The easy polish  
Just wipe on &  
wipe off. Stain  
resistant. High  
gloss. 16 ounce

ARMOR ALL  
PROTECTANT

Reg. 1.89 **99<sup>c</sup>**

Protect and beautify  
vinyl, wax, leather  
and wood. Sinks  
in & becomes part  
of surface. 8 oz

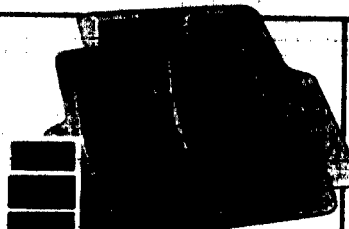

VINYL FLOOR MATS

Regular 5.99 Pair!  
Clear or tinted Lido  
Vinyl mats resist  
wear and are easy to  
clean! Smoke, green, clear and blue.  
Rear Mats. 68-4950-54 Pr. **3.99**

**4<sup>99</sup>**  
Front Pair  
66-4940-44

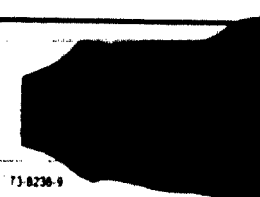

OIL-TANNED CHAMOIS

Regular 4.99. Streak-  
free! 2 square feet **4<sup>49</sup>**



CAR WASH/WAX

Reg. 16c **8 FOR 88<sup>c</sup>**  
Each

One-Step wash and wax! Add to water



40 PC. SOCKET  
SET-1/4 & 3/8 INCH

Regular 18.99 **14<sup>99</sup>**  
Value!

1/4 & 3/8 in. square drive  
metric & non-metric sockets  
1/2 inch extension bar, adapters,  
spark plug socket, spinner & sockets

94 PC. SOCKET  
& TOOL SET

**47<sup>99</sup>**  
45-2941-8

Regular 54.99 Value!  
& 3/8 in. drives Std. &  
metric. Most necessary  
tools & sockets. Case  
100 Pc. Set 45-2942-6 73.99

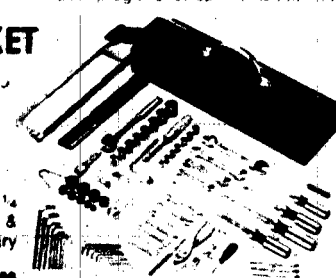

WINDSHIELD  
WASHER SOLVENT

Pre-mixed All-season  
Strong formula cleans  
off tough dirt & grime!  
**99<sup>c</sup>**  
78-9772-1

# OUTFIT YOUR TRUCK



W.A. has a Full Line of Useful Truck Accessories

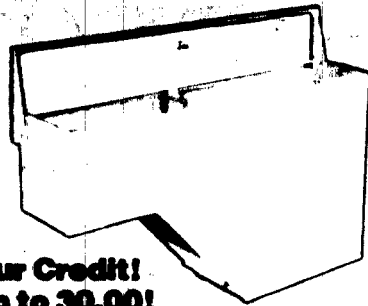
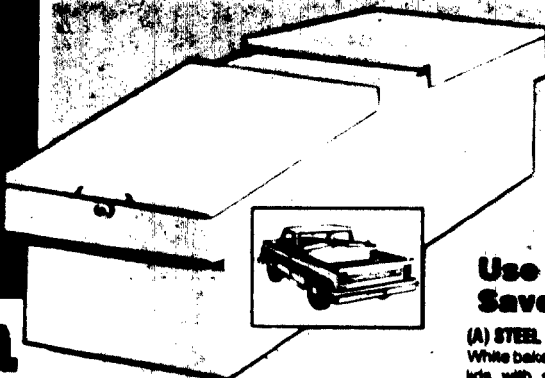

**Use Your Credit!  
Save up to 30.00!**

**(A) STEEL TOOL BOX FOR MOST U.S., IMPORT PICKUPS**

White baked enamel finish 18 ga. steel body. Two lds with spring loaded support bars. Lift-out trays. 19-1001-02 Regular 178.99

**89<sup>99</sup>**

**(B) STEEL WHEEL WELL CHEST FOR MOST PICKUPS**

Lid reverses to install on either side. Handy lift-out tray. Complete with mounting pad and hardware. 19-1010-5 Regular 78.99

**59<sup>99</sup>**

**(C) ALL STEEL TOTE RACK WITH SCREEN FOR PICKUPS**

Fits most wide bed models, available for narrow beds and compacts. White enamel finish. Mounts and hardware 19-1011-3 Reg. 78.99

**59<sup>99</sup>**

**WESTERN AUTO** Western Auto has the best Catalog Ordering System in town! At retail stores you'll know all contents if your items are in stock and when you can expect to get it!

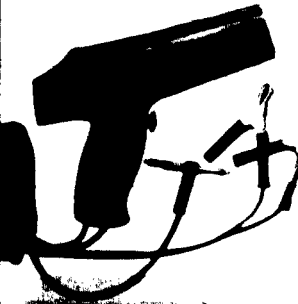
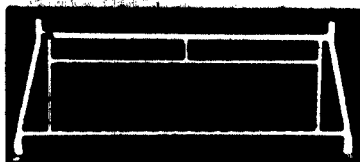

**SAVE 8.11! XENON TORCH LIGHT**

1488

offer all 12-volt vehicles & safety polarity protection & with spark plug adaptor

BUY INDUCTIVE TUBE LIGHT 12-volt. 74-5785-8..... 34.98

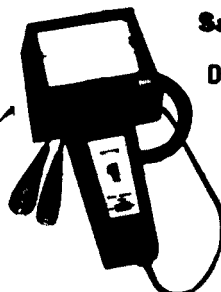

**Save 5.00  
PRECISION DWELL/TACH & POINTS TESTER**

**29<sup>99</sup>**

Regular 34.99 Value All 12-volt '4-'5-'6-'1



**REMOTE STARTER**

Heavy duty! Start engine from under hood

**4<sup>99</sup>**



**HEAVY DUTY IGNITION TUNE-UP KIT**

Most 57-74 GM Ford & Chry

**4<sup>99</sup>**

Save labor costs! Points, rotor & condenser

64-4653-98



**HEAVY DUTY DISTRIBUTOR CAP**

Most U.S. Cars **4<sup>69</sup>**

74-5772-1



Save 1.00

Regular 7.99

**VACUUM & FUEL PUMP TEST GAUGE**

0-25 0-60 cm vacuum 0-7 psi 0-5 kg cm<sup>2</sup> pressure

**6<sup>99</sup>**



**SPARK CABLE SET**

Most 8-cylinder cars Most 6-Cyl. 64-2100-02 **8<sup>99</sup>**

74-5772-1

**YOUR CHOICE!**

**WYNN'S ENGINE TUNE-UP OR WYNN'S SPIT FIRE GAS TREATMENT**

Reg. 1.49 Value **99¢** 18 Oz. EA.

For a smoother, quieter running engine.

78-1315-16



**(A) FAMOUS WD-40 SPRAY PROTECTION**  
Penetrates lubricates displaces moisture Even dries wet ignition! 78-1378-5 9-Oz. **1<sup>19</sup>**

**(B) EFFECTIVE STP GAS TREATMENT**  
Add it to your gas to clean your car's entire fuel system for economy 78-1312-4 8 Oz. **69¢**  
12-Oz. STP Gas Treatment 78-1313-2 99¢

**(C) GUMOUT CARBURETOR CLEANER**  
Pour it in your tank Cleans and conditions for performance 78-6950-6 1 Pt. **1<sup>49</sup>**

**(D) GUNK ENGINE BRITZ DEGREASER**  
Just spray on, let set, then rinse away dirt, grease and grime 78-6944-9 16 Oz. **1<sup>19</sup>**

# HI PRESSURE GREASE GUN

Reg. 7.99  
Fast & easy to load Hi pressure to 10 000 lbs!  
Uses 14 1/2 oz cartridge or bulk grease  
14 1/2 oz. Cartridge 78-3304-9 2 for 99c

**499**



Reg. 99c Each!  
**TYPE F OR DEXRON TRANSMISSION FLUID**

**YOUR CHOICE 69c**

Quart can



## TRANSMISSION FILLER

Regular  
1.29 Value!  
With plastic funnel  
Has rigid hose

**89c**

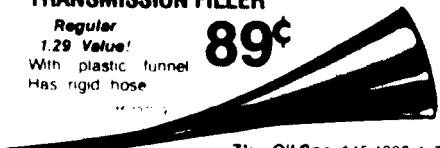

7 1/2 Oil Spout 15-1006-4 79c

# CASE LOT OIL SALE



**24 QTS. WEARWELL MOTOR OIL**

**YOUR CHOICE**  
20, 30, 40 Wt.  
Reg. 14.16 Value!

**999**

Excellent for low compression engines or applications where additives are not needed

24 Qts. 10W30 78-1870-1 12.00  
50c per Quart!

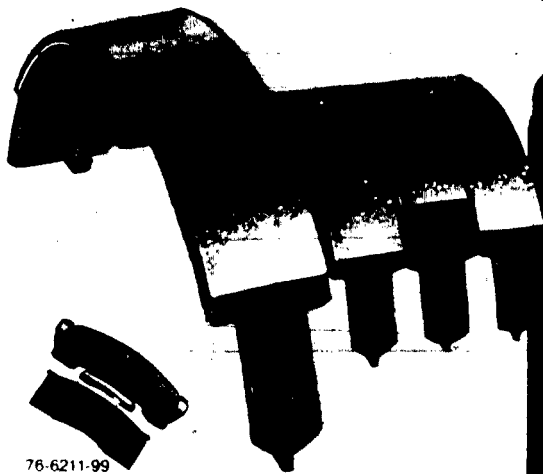

76-6211-99

## "30" BRAKE SHOES

Regular 8.99 Value! Brake shoes so good they meet original equipment specifications! Retined by experts using excellent friction materials

**599**  
With Exchange

**HIGH QUALITY DISC BRAKE PADS** Meet or exceed original equipment specifications!

**999**

Shoes & Pads sold in sets of 4 for 2 wheels.

**Save 3.11**  
**THRUSH MUFFLER\***  
For a meaner  
"Mean-Machine"

Regular  
16.99  
Value!

**1388**

Straight-through design amplifies engine purr  
Zinc-plated steel shell

\*In order to comply with California & Florida exhaust system certification regulations, a Thrush Silencer 177-1900 kit must be purchased & installed with Thrush Muffler.



# BATTERY SALE!

Save \$7  
**POWER PACKED CHARGER 42**

Regular 49.99  
 Thinwall polypropylene case with 12" more space inside than rubber cases. Fits most cars with standard size engines.

**42.99**  
 With Exchange 85-1830 40 50 72 '74

Get the power you need—Use Credit!

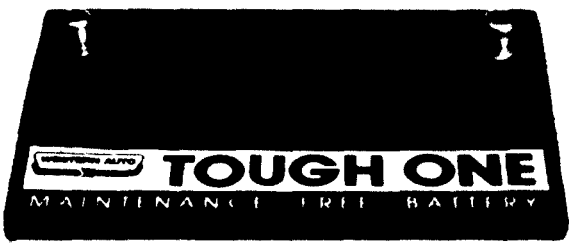

Save \$10

**TOUGH ONE 60 MAINTENANCE FREE BATTERY**

Reg. 64.99—Our finest battery fits most cars! Unleashes about 20% more amps than our next-best battery. Handles big cubic inch engines loaded with accessories. Save today!

**54.99**  
 With Exchange 85 7030 86



12V Deep cycle battery is ideal for use with electric fishing motors and RVs.  
 For continuous power over long periods.



**80 AMP GOULD ACTION PACK™ BATTERY**

Regular 58.99—Whisper quiet, constant discharge & long life up to 4 years. Longer than any other starting battery. Heavy duty.

**49.99**

105 Amp Gould Action Pack Battery 85-1830 59.99

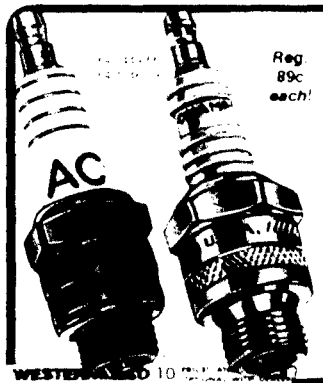

Reg. 89c each!

**SUPER SPECIAL**  
**AC OR CHAMPION SPARK PLUG**

O.E.M. replacements. See your Western Auto dealer for applications.

**74¢**

Your Choice! Champion or AC Resistor Spark Plugs. 64 1380-97 1470-87 94c



Save \$2.99  
**12 FT. POWER CABLES**  
 Regular \$5.99  
 Now \$2.99  
 85-1830 86



**SUPER SPECIAL**

Save up to 47% Now

For Cars, Construction, Repairs! Work Vertically, Horizontally!

**HYDRAULIC JACKS**

1½-TON **688**  
Regular 12.99

3-TON **988**  
Regular 16.99

5 TON 15.99  
8 TON 23.88  
12 TON 28.88

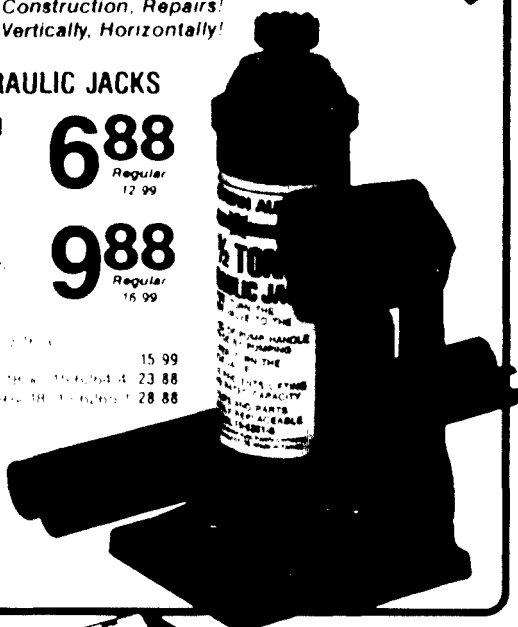

**Special! Save \$3 HEAVY DUTY SENTRY SHOCK ABSORBERS**

For Most Late Model American Cars

**6.99** EACH

Regular 9.99 Each

- Full length steel piston
- All welded construction—strong and durable
- Include hardware & installation instructions

Meet or exceed original equipment performance specifications!

Get All Your Auto Needs Now—Use Your Credit



**STEEL CAR RAMPS**

Now Low **1788** PAIR

Regular 28.99

Work under your car in comfort!

10½" LIFT STEEL RAMPS



**DIAL**



REG. 3.49 GE "PLUS 25" HEADLAMP

**2.59** 84-0108-1

For 2-lamp systems, 12v. HI or LO BEAM. For 4-lamp systems 2.29 EA 84-0120-23

Western Auto has the best Catalog Ordering System in town! At most stores, you'll know in seconds if your item is in stock and when you can expect to receive it!

Save at **1.88** Regular 3.29 15-8761-9

4-00 LB. TIRE AIR PRESSURE GAUGE

14" Size **2.69** 15-5100-1

3-WAY TIRE/RIM WRENCH

28" RIM WRENCH 3.49 15-5101-9

Reg. 3.88

You Save 1.30 WESTERN AUTO'S "75" TIRE PUMP

Regular 3.89 Value **2.59** 15-8405-3

W.A.'S "100" TIRE PUMP 15-8409-5 NOW 4.99

"TOUGH ONE" BUTYL TUBES

Regular 6.49

Most popular sizes bias ply & belted tires.

**3.99** Plus 21¢ FE T.

**SUPER SPECIAL**

**MECHANIC'S CREEPER**

\$5 Off!

**9.99** Regular 14.99

- Varnished plywood—reinforced
- All way easy roll 2" x 2" steel casters
- 36 x 15" inches with padded headrest



**CHECK OUT THESE SUPER W.A. AUTO SOUND VALUES!**

**Save UP TO \$40**

**Save \$50**

**Save \$70**



**YOUR CHOICE**

**AM/FM/STEREO RADIO WITH 8-TRACK OR CASSETTE TAPE PLAYER**

**79<sup>99</sup>**

*Regular Values to 119.99*  
Both designed for easy installation. Has AF, FM, minimize FM static, split. Both have volume, tone, treble, bass & tuning controls. Fast forward eject button for cassette. Change of range for 8-track.

**AM/FM/STEREO with CASSETTE**

**59<sup>99</sup>**

*Regular 109.99 Value!* Includes pushbutton cassette tape player. Features AM, FM, selector and FM lock-out start switches. Stereo light. Locking pushbutton cassette fast forward and eject. Hear your favorite tapes as you drive. See Western Auto for performance matched speakers too.

**PUSHBUTTON**

**AM/FM/STEREO with 8-TRACK**

**99<sup>99</sup>**

*Regular 169.99 Value!* Includes all the standard system. Has AM, FM, volume, tone, treble, bass, minimize FM static, start, lock-out, fast forward, volume, tone, bass, treble, and meter. Pushbutton change of range and tape eject.

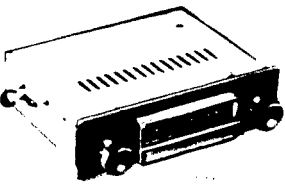

**UNDER-DASH AM RADIO**  
**19<sup>99</sup>**  
*Regular 22.99*

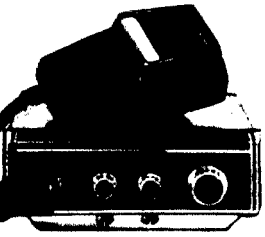

**Save \$30**  
**40-CHANNEL CB**  
**59<sup>99</sup>**  
*Regular 89.99* — Transmitter light right on top of unit for easy viewing. Volume & squelch controls. With mounting hardware.

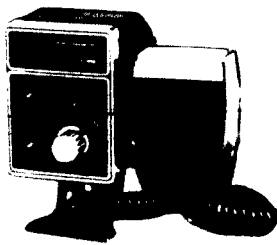

**LESS THAN 1/2-PRICE!**  
**MODULAR CB**  
**79<sup>99</sup>**  
*Regular 159.99*

40-channel with volume & squelch controls on microphone. TX light and meter.

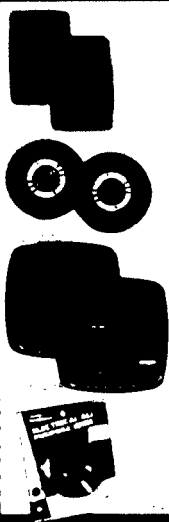

**6x9 IN. SPEAKERS**  
*Reg. 25.99 Price*  
**14<sup>99</sup>**  
*Regular 19.99*

**20 Oz. Coaxial**  
*Reg. 29.99*

**5 1/4 IN. FLUSH-MOUNT**  
*Reg. 34.99 Price*  
**24<sup>99</sup>**  
*Regular 34.99*

**JENSEN SPEAKER KITS**  
*Reg. 42.99 Price*  
**34<sup>99</sup>**  
*Regular 42.99*

**ALL PURPOSE WIRE**  
*Reg. 2.09 Value!*  
**1<sup>99</sup>**  
Handles most auto electrical needs.



**BRIGHTEN YOUR DAY WITH TRUETONE!**

**Save \$2 Now!**  
**AM/FM RADIO**

18.99 **Value!** **16<sup>99</sup>**

Take advantage of this great opportunity to save on a high sound quality radio. Built in AM to suit in stations from far away. Works with batteries or electricity. Comes with earphone. Great traveler! Measures only 7 1/2" x 6 1/2" x 3 1/2".  
**FM/AM Radio: 23-3975 B 16.99**

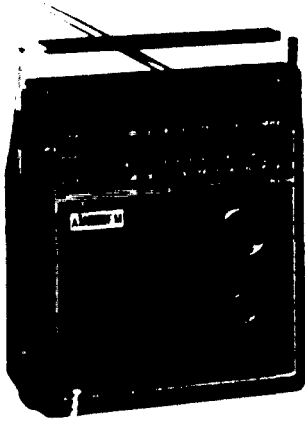

**MORSE CODE WALKIE/TALKIES**

Reg. 13.99 **12<sup>99</sup>**  
Pair

Solid state walkie talkies have Morse code key and pushbutton talk control.

**Walkie Talkies with AM Radio: 23-4201-2 17.99 Pr.**



**Save \$2!**  
**FM/AM POCKET SIZE RADIO**  
**9<sup>99</sup>**

Regular 11.99 Value! Perfect size to take along anywhere. Tunes in stations from far away. With earphone.

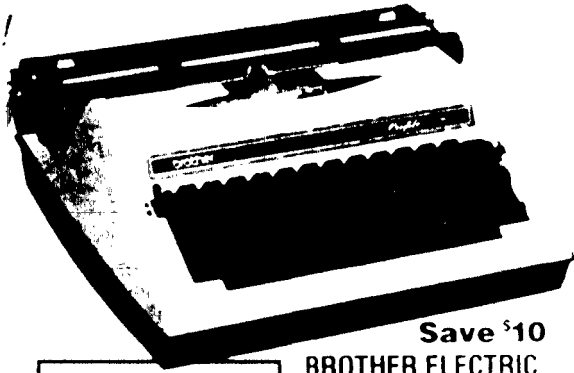

**Save \$10**  
**BROTHER ELECTRIC**

Reg. 199.99 **189<sup>99</sup>**  
Value

Deluxe Electric 229.99

**CITATION PORTABLE**  
Reg. 84.99 **79<sup>99</sup>**

Electric with Cassette Correction System and 4 keys 259.99

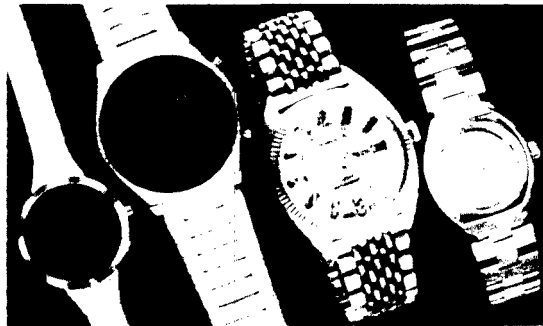

**YOUR CHOICE OF WATCHES!**  
**DIGITALS AND STANDARDS**

**29<sup>95</sup>**

- (A) Ladies' LED Digital Watch
- (B) Men's LCD Digital Watch
- (C) Men's Yellow 17 Jewel
- (D) Ladies' White 17 Jewel
- Men's 17 Jewel—4 Styles

Vivitar quality at a bargain price—Just in time for summer!

**Vivitar**



**Save \$2 Now!**  
**VIVITAR POCKET CAMERA**

Reg. 46.99 Value, **44<sup>99</sup>**  
Regular 49.99

Vivitar 110 With Telephoto 74.99



**FM/AM CLOCK RADIO**

Regular 39.99 Value! **36<sup>99</sup>**

LED readout. Wake 'n' alarm or music. Has sleep to music timer and snooze timer. Auto display dimmer.



**FM/AM TABLE RADIO**

Regular 24.99 Value! **19<sup>99</sup>**

Side-scan tuning. White plastic case and black trim. Built-in antenna. Conveniently portable! Buy now & save!



**Compact 2148's. All right in your hand!**



**Both with 4-Key Memory!**

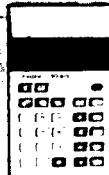

**BILFOLD CALCULATOR**

**16<sup>99</sup>**  
Regular 17.99

**DELUXE UNISONIC**

**13<sup>99</sup>**  
Regular 14.99

W.A. has a Super Selection of  
Zebco, Garcia, Daiwa and  
Johnson Rods & Reels!

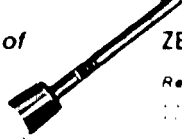

ZEBCO 2490 SPIN-CAST COMBO

Regular 15.99  
**14.99**

ZEBCO 1545 SPIN-CAST COMBO

Regular 13.99 Value  
**12.99**

JOHNSON SPIN-CAST COMBO

Regular 16.79 Value  
**13.99**

ULTRA-LIGHT MINICAST COMBO

Regular 23.98 Value  
**18.99**

SPIN-CAST ROD & REEL COMBO

Regular 8.48 Value  
**7.99**

**YOUR  
CHOICE  
FISHING RODS**

**9.99**  
EACH

Reg. up to 11.49

Get All Your Fishing  
Needs at Your  
Western Auto Store!

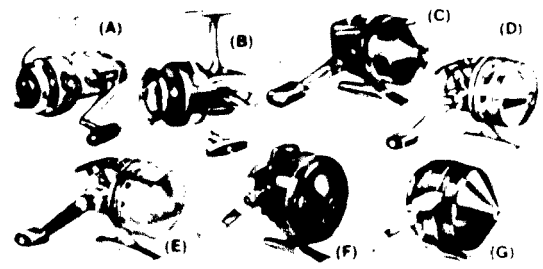
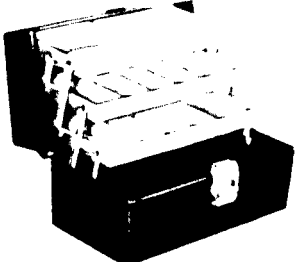
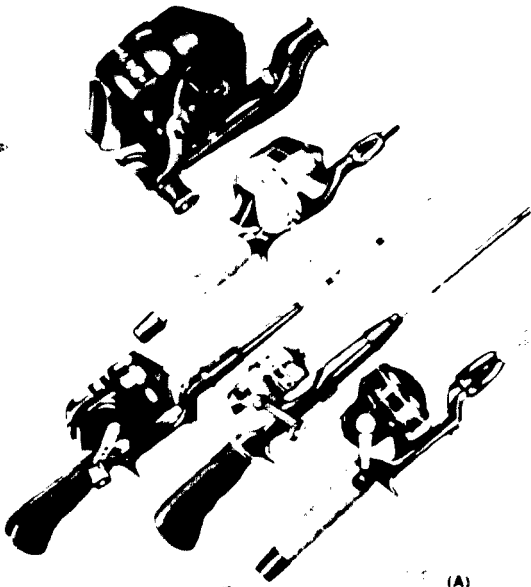

**BAMBOO  
FISHING  
OUTFIT**  
**2.19**

**Save 1.40 Now!  
THREE-TRAY BOX**

Regular 8.39  
**6.99**

Three Tray Box with 24 compartments, 24-45757 8.49

- (A) Zebco 850L Spinning Reel 20.99
- (B) Daiwa 403 Spinning Reel 8.79
- (C) Johnson Spnte Ultra Light Reel 13.99
- (D) Daiwa 208RL Spin Cast Reel 12.49
- (E) Daiwa 210RL Spin Cast Reel 16.99
- (F) Johnson Century Reel 14.99
- (G) Zebco 808 Spin Cast Reel 21.99

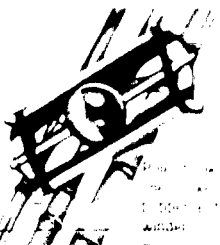

**INFLATABLE BOAT**

Regular 20.99  
**18.99**

- Two-Man Boat 37-1510-8 37-1510-9
- 3-Man Boat 37-1515-8 38.99
- Paddles 37-1502-6 5.99
- Pump 37-1600-8 5.99



**Coast Guard  
Approved  
ADULT LIFE VEST**

**5.69**

- Child's Vest 45 lbs 37-4116-2 4.99
- Child's Vest 45-90 lbs 37-4117-03.29

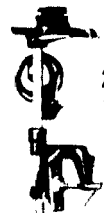

**2 SPEED ELECTRIC  
TROLLING MOTOR**

**44.99**

Pivotal 360 steering 2 position tilt

- 18 Spd. Motor 37-6974-2 74.99
- 28 Spd. Motor 37-6976-7 94.99

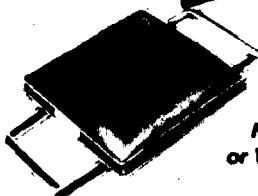

**Your Choice  
BOAT CUSHIONS**

Nylon  
or Vinyl

**6.29**



**BATTERY BOX**

**5.49**

# Use Your Credit!

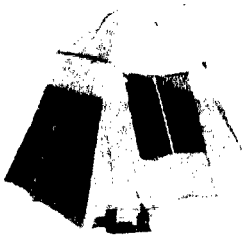

**7x7 FT. HIKER TENT**

Nylon—weighs just 7 1/2 lbs. sleeps 2 or 4

**59<sup>99</sup>**

8x10 Tent 44-6422-8

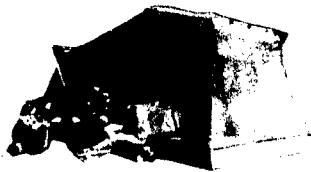

**Save 20.00**

**SCREENHOUSE FAMILY TENT**

9x15 ft. overall  
Durable polyethylene fabric, 5/8" screen

**99<sup>99</sup>**

Sleeps 6! Regular: 119.99

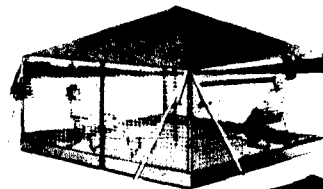

**You Save 13.00**

**12x12 SCREEN HOUSE**

7 1/2 ft. high  
at center

**46<sup>99</sup>**

Lightweight polyethylene screen supported by 6 A.Z.P. poles

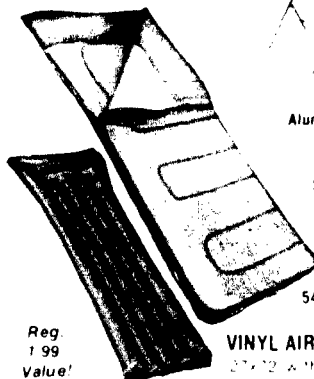

Reg. 1.99  
Value!

Aluminum Camp Chair 44-7008-8 5.49

**CAMP STOOL**

Reg. 2.49 **1.99**

Flipping hardwood frame and tough non-woven!

**3 LB. NYLON SLEEPING BAG**

**Save 2.00**

Regular 15.99

**13<sup>99</sup>**

3 1/2" x 75" with 40 zipper

3 Lb. Cotton Bag 44-886-8 16.99

54x72 Ground Cloth 44-886-9 1.99

**VINYL AIR MATTRESS 1.49**

27x72 With two valves

30x74 Vinyl Air Mattress 44-5952-2 2.66

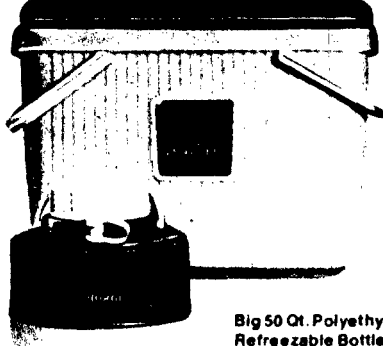

**Big 50 Qt. Polyethylene Chest with Two Refreezable Bottles & Tray 44-1295-3**

**33<sup>99</sup>**

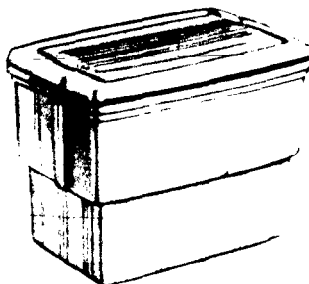

**30-Qt. STYROFOAM CHEST**

48 Qt. Chest 44-1283-9

Reg. 3.99 **1.49**

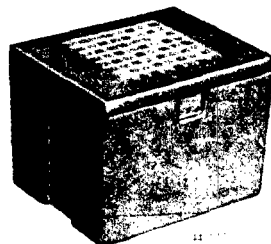

**28 Qt. LOW PROFILE CHEST**

1 1/2" thick styrofoam and just 12" high. Easy to pack and carry

**4<sup>99</sup>**

45 Qt. Chest 44-1274-8 7.99

82 Qt. Chest 44-1273-0 12.99

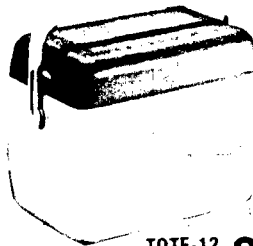

**TOTE-12 BEVERAGE CHEST**

Refreezable Bottle 44-1291-2 1.49

Reg. 8.99 **8<sup>99</sup>**



**VINYL 6-PAK BAG**

Insulated zippered

12-Pak Bag 44-1271-4

**1<sup>99</sup>**

3.49

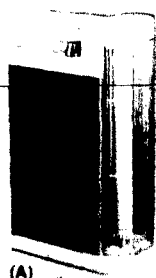

**(A) Fluorescent Camp Lantern**  
Strong, glare-free white light. 9 1/2" h. 44-5601-8 **9<sup>99</sup>**

**(B) 6-Volt Table Lantern**  
Stand on table, or hang by shade. 28-5000-6 **3<sup>99</sup>**

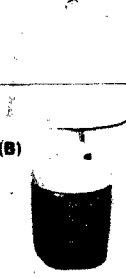

Prices Less Batteries

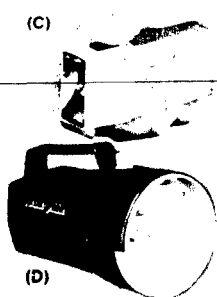

**(C) Disposable Flashlight**  
Handy in pocket, pack or glove box. 28-4245-8 **99<sup>c</sup>**

**(D) Rechargeable Hand Lantern**  
Up to 4 hours of light on a charge. 28-4405-8 **18<sup>99</sup>**

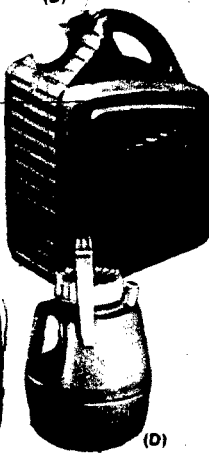
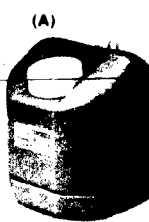

**(A) 5 Qt. "Tip 'n' Tap" Cooler Has Refreeze Bottle.** Double walled Polyurethane foam insulated. Wide neck keg faucet 44-1345-6 **7<sup>99</sup>**

**(B) 3 Gallon Polyethylene Water Jug.** One-piece molded with long neck pour spout. 44-1358-9 **2<sup>99</sup>**  
5-Gallon Size 44-1359-7 **3.99**

**(C) 1 Gal. Steel Shell Cooler.** Insulated with non-rust plastic bottom—seamless poly liner 44-1304-3 **5<sup>99</sup>**

2 Gal w/Spigot 44-1308-4 **10.99**  
**(D) Gallon-Size Handy Beverage Pitcher-Jug.** Seamless high impact plastic with an easy-pour spout 44-1312-6 **2<sup>79</sup>**

Real racing-style box handlebars

- Built tough for racing over rough terrain!
- BMX tread tires give super traction
- 6½ inch crank arm for extra torque
- Rear wheel has quick sprocket change
- Efficient safety reflector system

Our new "Western Flyer Mag" is the latest in bicycle design! From its sharp mag wheels to its chrome handlebars, it's a winner!

**119<sup>99</sup>**  
11.999  
 34-2766

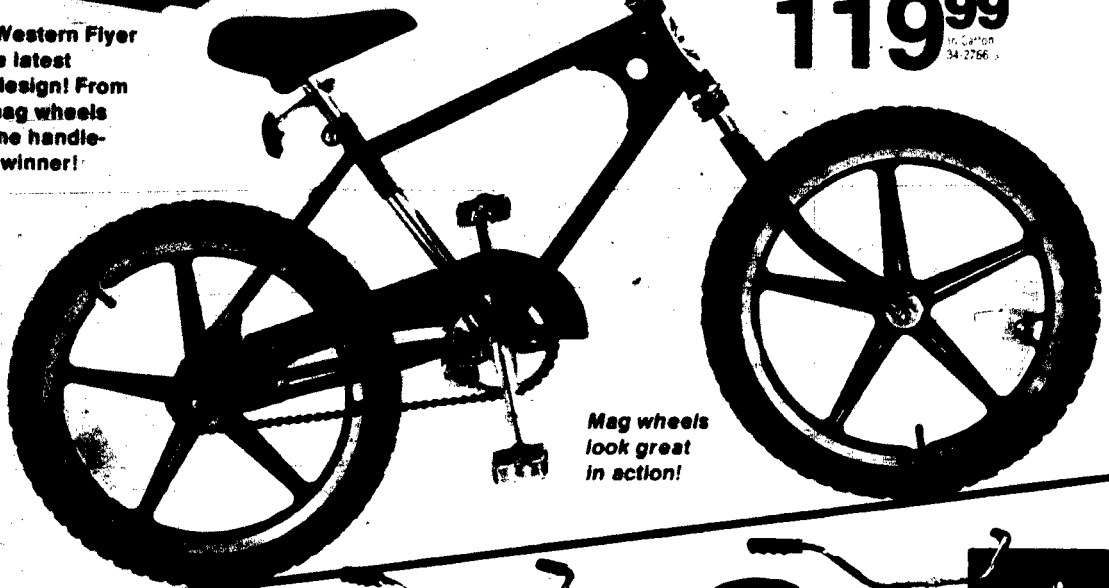

Mag wheels look great in action!

BMX Knobby tires give the grip you need!

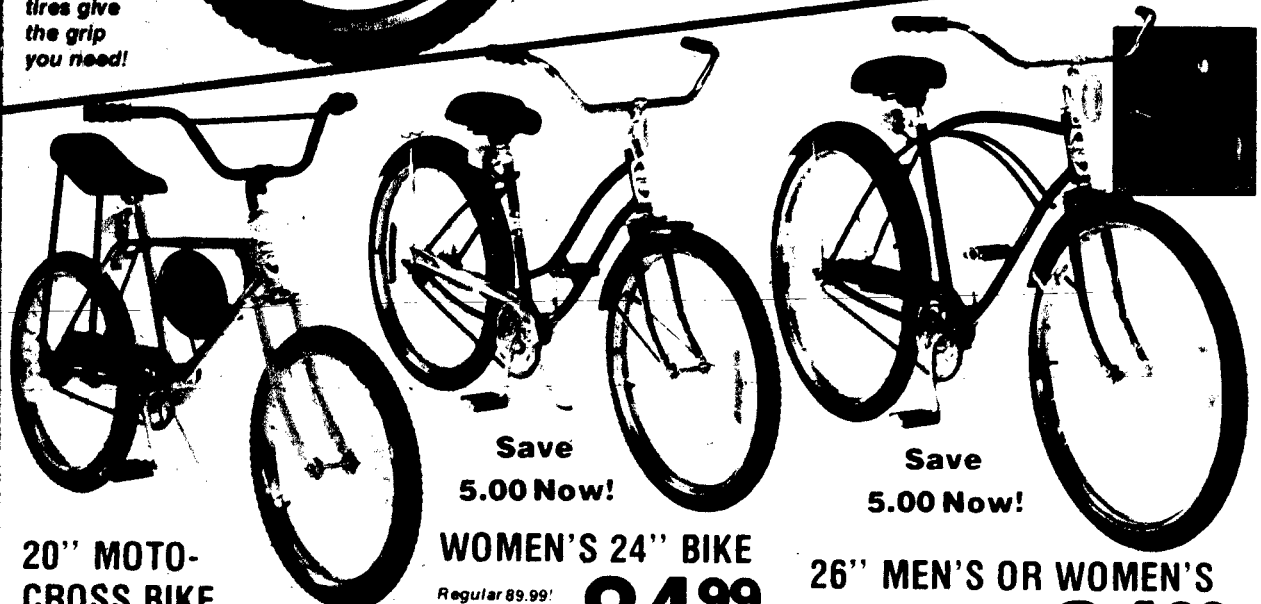

**20" MOTO-CROSS BIKE**

**58<sup>99</sup>**

Tough "Dirt Duster" makes its rider king of the race track! Has a rugged steel frame, real moto-cross style box handlebars, number plaque and rat trap pedals!

**WOMEN'S 24" BIKE**

**84<sup>99</sup>**

Regular 89.99! Scaled down middleweight is easily carried up & down stairs, yet it's heavy enough to really grip the road! Has steel frame, chrome handlebars, coaster brakes and reflector system for safe riding!

**26" MEN'S OR WOMEN'S**

**84<sup>99</sup>**

Regular 89.99 Value! Good basic bike for transportation or fun. Features strong cantilever steel frame, chrome handlebars & reflector system. Men's is burgundy & women's is brilliant blue. Sleek Deluxe 26 inch Model. 34-2024-7 96.99\*

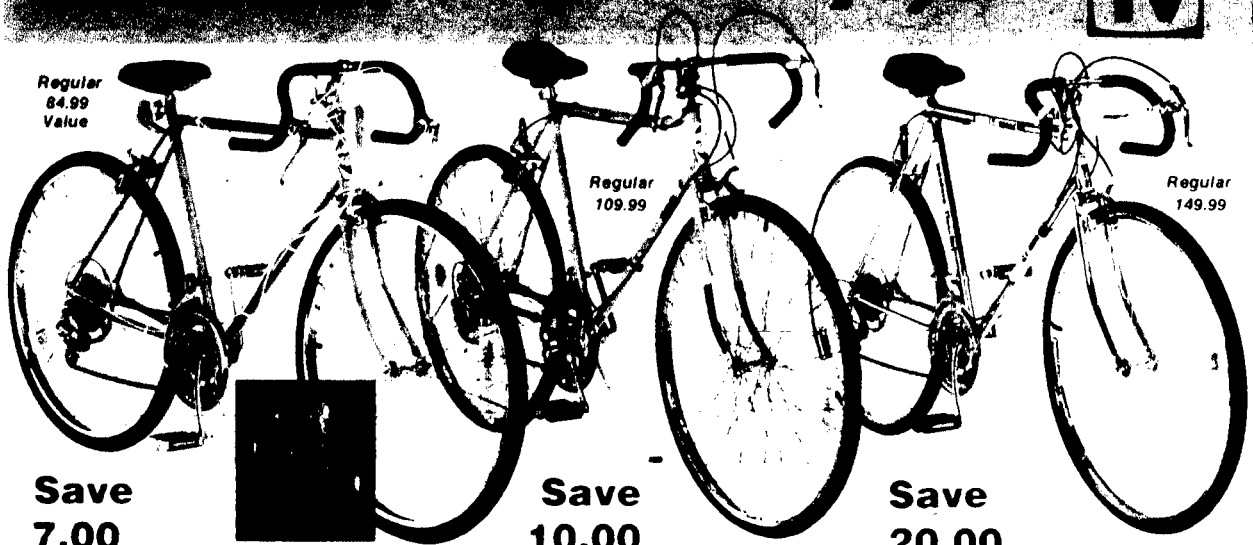

Regular  
84.99  
Value

Regular  
109.99

Regular  
149.99

Save  
7.00

Save  
10.00

Save  
20.00

## BOY'S OR GIRL'S 10-SPEED

Light weight racer has quick response 10-speed derailleur system. Side-pull caliper brakes. Yellow frame. Buy 2 has 21" frame, quick release.

**77<sup>99</sup>**

## MEN'S 27" BIKE

27" wheels  
57" frame  
Derailleur  
10 speed  
caliper  
brakes

**99<sup>99</sup>**

Deluxe 27" Men's Racer 94.99 + \$119.99\*

## 27" 12 SPEED RACER

27" wheels  
57" frame  
Derailleur  
12 speed  
caliper  
brakes

**129<sup>99</sup>**

Deluxe 27" 12 Speed Racer 119.99 + \$119.99\*

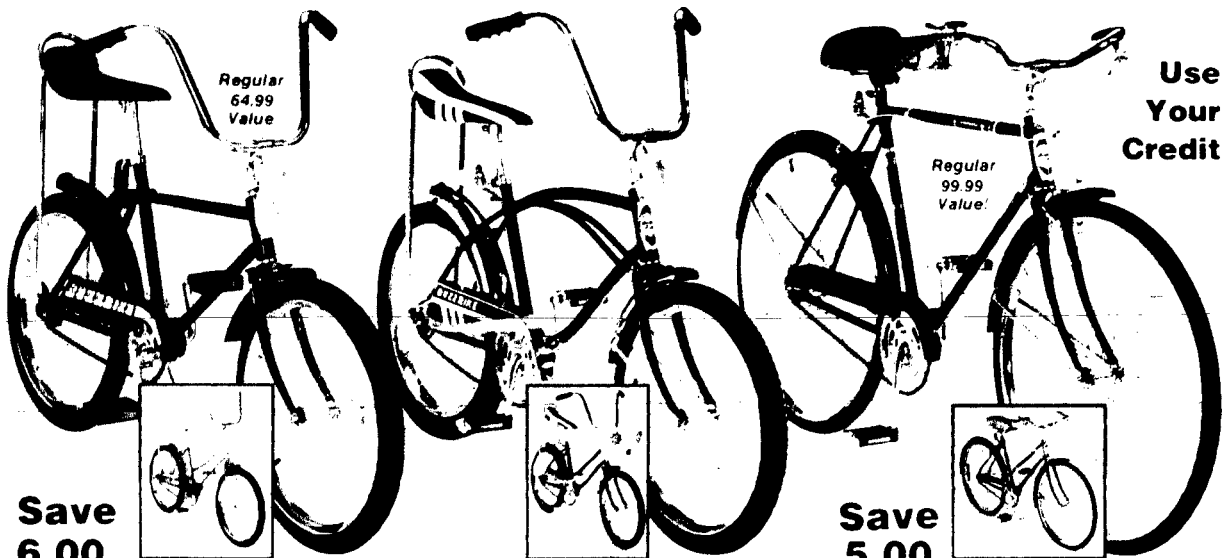

Regular  
64.99  
Value

Regular  
99.99  
Value

Use  
Your  
Credit

Save  
6.00

Save  
5.00

## FLASHY BUZZ BIKES

20" Boy's regular or 15" girl. Steel frames, fender and handguard. Padded seats. Nylon tires. Coaster brakes, disengageable system.

**58<sup>99</sup>**

## 20 INCH BUZZ BIKES

Boy's or girl's. 20" wheels. Steel frames, fender and handguard. Padded seats. Nylon tires. Coaster brakes, disengageable system.

**77<sup>99</sup>**

## 26 IN. 3-SPEED BIKES

Boy's or girl's. 26" wheels. Steel frames, fender and handguard. Padded seats. Nylon tires. Coaster brakes, disengageable system.

**94<sup>99</sup>**

26 Inch 5-Speed Bicycle 97.99\*  
24 Inch 10-Speed Bicycle 97.99\*

# SAVE ON BIKE ACCESSORIES

**SUPER SPECIAL**



**TWIN-STRIPE SLICK PLUS TUBE**

Reg. 3.99  
Tire & Tube  
You'll BUZZ on by the rest of 'em!

**2.99**

Save \$1



Regular 2.99 Value

**BIKE PEDALS 1.99**

Amber reflectors on both sides. Sizes to fit most bikes.

Save 40c



Regular 1.39

**BIKE GOOSE HORN 99c**

Makes bike riding safer. Fully chrome plated. Dual tone. 9 inches long.



Regular 4.79 Value

**BIKE BASKET 3.49**

Steel frame. Shiny! 15x10x4 1/2 in. dia.

Reg. 5.99



**HEADLIGHT 4.99**

Generator. Fits on front fork of most bikes. Easy to mount.

Reg. 5.49 Value



**HORN HEADLIGHT 4.99**

Bright two bulb light for extra safe riding. Powerful horn. Remote switch. Chrome.



**DAY-GLO BIKE BAG 2.49**

Regular 2.99 Value. 9x5 inch roll bag has zipper close.



**TIRES & TUBES 4.66**

33-5826-5926  
Reg. to 7.00!  
Styles and sizes to fit most bikes.

Save 50c



**BIKE FLAG 2.49**

Reg. 2.99  
High visibility. Helps warn drivers. Day-glo orange.



Save 20c

**WAFFLE-STYLE GRIPS 79c**

Regular 99c Value. Moto. Cross black vinyl. Great grip!



**WHEEL REFLECTORS 1.59**

Regular 1.99 Pair! Wide angle reflectors for safe night riding.



**14.99**

33-7325-5  
Regular 18.00  
**BUMPER MOUNT CARRIER**



Reg. 1.99

**HANDY WATER BOTTLE 1.59**

1 pint water bottle. So convenient for long trips! Has clamp.

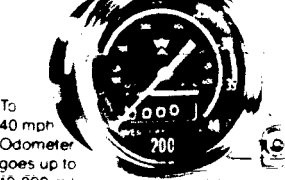

To 40 mph. Odometer goes up to 10,000 miles.

**SPEEDOMETER 7.99**

Regular 8.99 Value.



**SPRING HI-RISE SADDLE 4.99**

Durable vinyl seat gives your bike that custom look! Universal clamp fits on any bike. Give your wheels a new look!

Save 1.50



**LOCK AND CABLE 4.49**

Reg. 5.99 Value. Heavy-duty, 8 ft. long chain. Lock has two keys. A necessity!



Reg. 6.99 Value

**Set of Two TRAINING WHEELS 4.99**



38" CHIEF WAGON

2" Wheel Steering

Reg. 28.99

**25.49**

17 1/2 x 26 1/2 x 36"  
34" Red Rocket 35-1342-1 21.99



Regular 21.99 Value!

Save \$6

**SKATEBOARD 15.99**

27" Duraflex® board has adjustable trucks. Red, green & yellow.  
24" Polypropylene. 36-3148-8 6.99



# GET 'EM AN EXCITING WHEEL TOY!

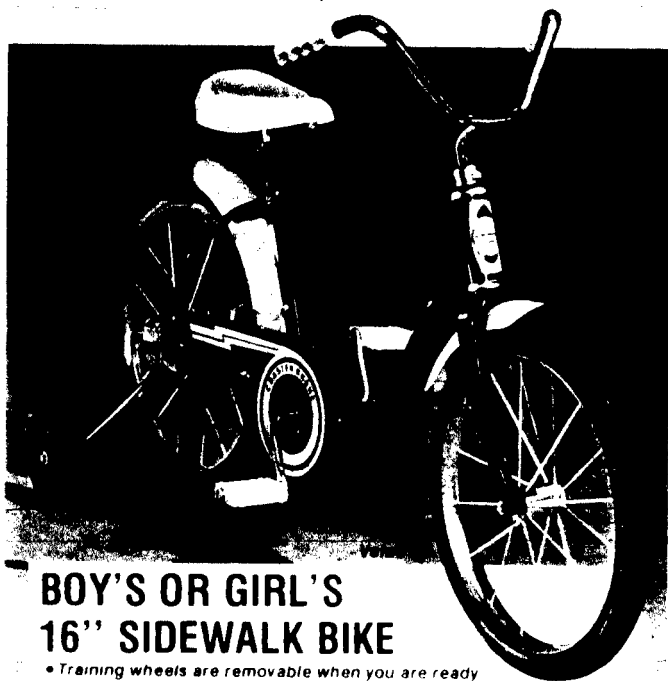

## BOY'S OR GIRL'S 16" SIDEWALK BIKE

- Training wheels are removable when you are ready
- Frames convert from boy's to girl's style
- Adjustable saddles for fast-growing kids

Sturdy steel frame with wide saddles and 16" x 1.5" casters. 17 removable training wheels.

**39<sup>99</sup>**

13 Inch Sidewalk Bike (12" x 1.5" casters) \$29.99

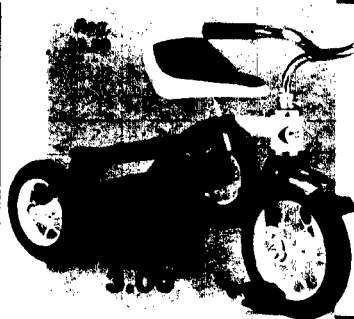

## DOUBLE STEP TRIKE

**20<sup>99</sup>**

Builds confidence in young children. Includes 12" x 1.5" casters.

12" x 1.5" casters \$23.99  
16" x 1.5" casters \$27.99

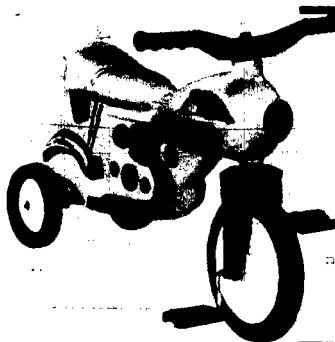

## Save 1.00 SPIDERMAN MOTORCYCLE

**10<sup>49</sup>**

Spiderman motorcycle. Includes 12" x 1.5" casters.



## STEEL FRAME TRICYCLE

**16<sup>99</sup>**

Sturdy steel frame. Includes 12" x 1.5" casters.

12" x 1.5" casters \$19.99  
16" x 1.5" casters \$22.99

W.A. has the best value ordering system in town. You'll know in seconds when you'll receive your item.

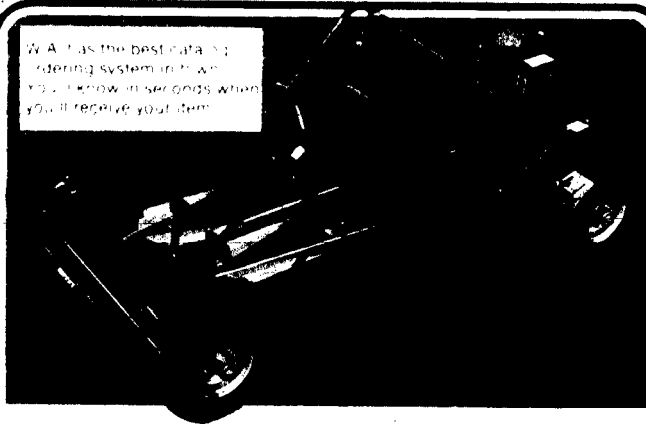

Regular 349.99 Value!

**Price Cut 50.00!**

## 3 H.P. SIDEKICK GO KART

**299<sup>99</sup>**

Share the fun with a friend riding side by side. This quality built sidekick go kart has a 3 H.P. engine gives this kart plenty of power. Features include center console, 5" tires, 14" front steering wheel, handstop button. Excellent gas mileage.

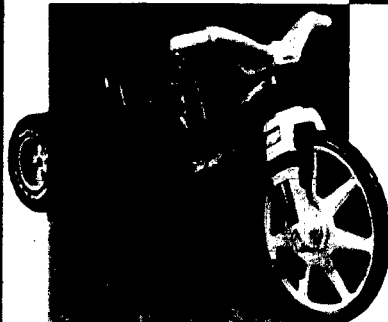

## BIG WHEEL CHAMPION

**27<sup>99</sup>**

Has a built-in motor. Includes 12" x 1.5" casters.

# SWING INTO SUMMER SAVINGS!

## ALUMINUM TENNIS RACKET

Regular 6.99 Value! Experience the power and control of this racket! Lightweight aluminum alloy frame with open throat design for a larger "sweet spot". Nylon strings.

**5<sup>99</sup>**  
36-2517-5

Lightweight Stainless Steel Tennis Racket. Nylon strings. 36-2518-3 ..... 6.49

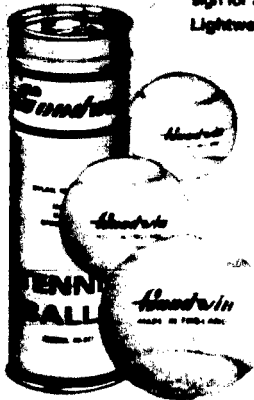

## TENNIS BALLS

CAN  
of  
3 **1<sup>99</sup>**  
36-2562-64

Official weight and size  
Yellow or white



## TENNIS HAT **2<sup>19</sup>**

Regular 2.39! 36-2557-1

Tennis Visor 36-2558-9 1.49

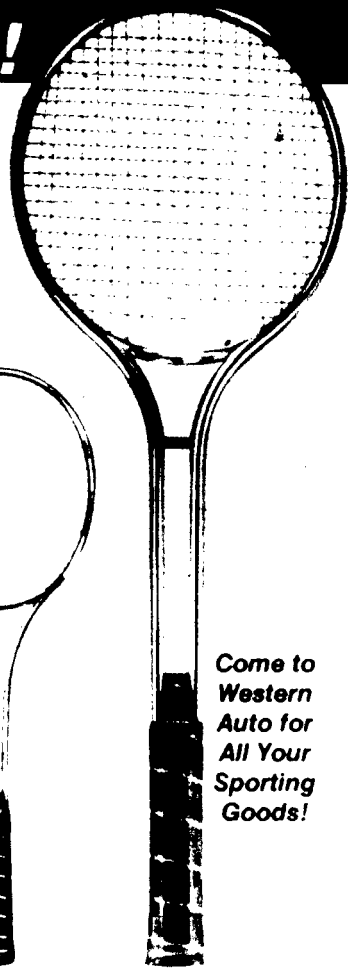

Come to  
Western  
Auto for  
All Your  
Sporting  
Goods!

## Save \$1! FIELDER'S GLOVE

**8<sup>99</sup>**  
36-1234-35

Regular 9.99 Value!

Quality leather glove with snap flex hinge, deep well pocket. All-leather lacing. Available in right or left-handed models.



## Save \$2 Now! SOFTBALL GLOVE

Regular 28.99  
Value! **26<sup>99</sup>** 36-1247-0

Wilson Fieldmaster® glove is all-leather with rawhide lacing. Gmp-Tite® pocket and snap action hinge. For right handed player.

## Save \$1 Now! BASEBALL GLOVE

Regular 14.99  
Value! **13<sup>99</sup>** 36-1250-4

All-leather glove with rawhide lacing. U-shaped heel, deep webbed pocket, snap-flex hinge. Fielder's mitt for right handed players.

## Save \$1 Now! SOFTBALL GLOVE

Regular 16.99  
Value! **15<sup>99</sup>** 36-1214-6

Quality softball fielder's glove of top grain steerhide. Rawhide lacing, snap-flex hinge, closed web design. For right handed players.

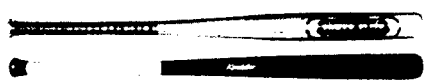

## SOFTBALL & BASEBALL BATS!

28 in. Hardwood Little League Bat 36-1415-3 2.99  
Aluminum Softball Bat 33 or 34 in. 36-1460-61 9.99  
Hardwood Softball Bat 33 or 34 in. 36-1455-9 3.99  
Ash Softball Bat (Not Shown) 33 or 34 in. 36-1456-7 4.39

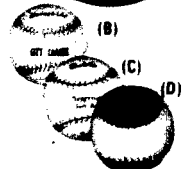

(A) CAT Diesel or Logo Cap 36-2036-38 2.49  
(B) "City League" Baseball Official 36-1516-8 1.19  
(C) Playground Softball White 36-1539-0 1.59  
(D) Playground Softball Asst. Colors 36-1540-8 1.99  
Official Softball with cork center 36-1551-5 3.99  
Official Little League Baseball 36-1523-4 3.19

# SAVE ON A VARIETY OF SUMMER GAMES, FUN FOR EVERYONE!

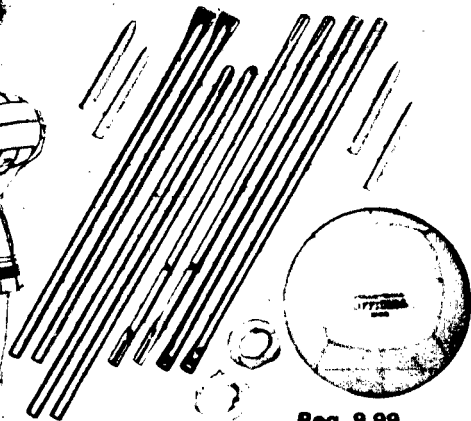

Reg. 9.99

**COMPLETE VOLLEYBALL SET 7<sup>99</sup>**  
36-4904-1  
 Regulation size white vinyl ball. With 20x2 ft. cotton cord net, two metal poles with metal stakes and tension cords. Family fun!



Reg. 5.99

**BADMINTON SET FOR 4 5<sup>49</sup>**  
36-2603-8  
 Complete outfit for backyard fun!  
 4 Plastic Shuttlecocks 36-2635-5 ..... 59c  
 Two Player Badminton Set 36-2600-9 ..... 2.29



Use Your Convenient Credit!

**Save '2**  
**4 PLAYER CROQUET SET 10<sup>99</sup>**  
36-2708-0

Four player set includes four mallets and balls. Wire wickets. Hours of fun for all ages! **SAVE!**  
 Deluxe Croquet Set 36-2711-4 ..... 19.99



Regular 3.49

**LAWN DARTS 2<sup>99</sup>**  
 For 2 or 4 adults

**SET OF 4 HORSESHOES**

Regular 12.49 Value!  
 Set of four steel shoes. Fun for the entire family!  
 With Stakes 36-2742-9

**10<sup>49</sup>**  
 16.49

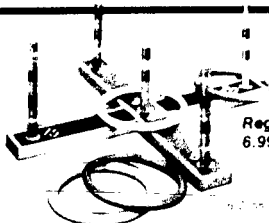

Reg. 6.99 Value!

**RING TOSS GAME 6<sup>49</sup>**  
 For 2 to 4 players. Includes 4 rings, wood target with pegs.



Reg. 6.59

**RUBBER HORSESHOES**

Durable rubber! Set of 4 shoes in 2 colors. 2 wooden stakes. **SAVE!**

**5<sup>99</sup>**



Regular 14.99

**SAVE '2**  
**750 BB RIFLE 12<sup>99</sup>**  
36-2041-9

Golden 750 has 500 shot capacity. 725 BB's ..... 21.99  
 Pump Rifle 36-3328-6 ..... 21.99  
 Air Rifle 36-3378-5 ..... 38.99



725 BB's 36-3461-5 Now 78c

U.S.A. air rifles are sold in strict adherence to state & local regulations.



**ROLL-UP HAT 1<sup>89</sup>**  
36-2026-27  
 Fits 6 7/8-7 1/2

Choose solid or print.

**GOLF BALLS 3 FOR 99¢**  
 Solid centers

36-2940-9

"Arnold Palmer" Golf Balls 36-2942-5 Now 3 for ... 2.29

# SAVE ON WESTERN AUTO. SUMMER FUN!



## Beat the Heat! HAPPY CIRCUS TRAIN POLY SPLASHER POOL

**15<sup>99</sup>**

6 ft. pool!  
A real summer-time pleaser for your family.

Polyethylene wall pool sets up in minutes to give your children hours of fun in the sun. Kids keep cool all summer long and for many years to come. Durable vinyl liner with drain plug and protective top coping of smooth plastic. 15 in. deep.

- 6 Ft. Dia. x 18 In. Deep Pool 32-1171-1 26.49
- 10 Ft. Dia. x 20 In. Deep Pool 32-1172-9 43.99
- Pool Aid Sanitizer 32-2200-7 2.49



## FLEX-WALL® INSTANT POOL

Regular 13.99 Value! Ready to use in 15 min. 10 ft. x 20 in. Dia. x 5 1/2 in. Deep. 20 x 20 in. x 2 1/2 in. Deep. 10 ft. x 10 ft. x 2 1/2 in. Deep. 10 ft. x 10 ft. x 2 1/2 in. Deep.

**11<sup>99</sup>**



## Save 1.50 SLIDE POOL

Reg. 13.49

**11<sup>99</sup>**

Slide pool with slide. 10 ft. x 10 ft. x 2 1/2 in. Deep. 10 ft. x 10 ft. x 2 1/2 in. Deep.



## PRE-FORMED 36" POOL

Reg. 4.49

**2<sup>99</sup>**

36" diameter. 10 in. deep.



## Save 1.00 POLY SANDBOX

Regular 4.99

**3<sup>99</sup>**

32x32x8. 10 in. deep.



## INFLATABLE POOL

Reg. 5.49

**4<sup>49</sup>**

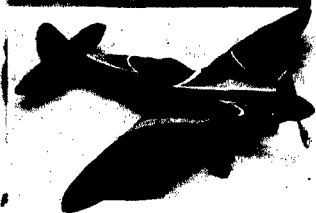

## ELECTRO CHARGER 'BLAZER' PLANE

Ages 8 & up. 29-2540-1

**8<sup>99</sup>**

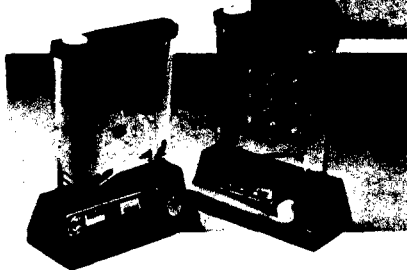

## WONDERFUL WATERFULS

Assorted games to enhance fun.

**4<sup>49</sup>**



## WESTERN AUTO TRACTOR TRAILER

Reg. 13.99 - 20 in. x 10 in. x 10 in.

**12<sup>99</sup>**

# W.A.!

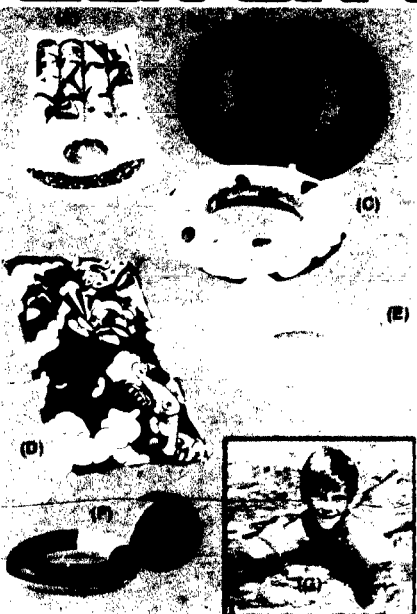

## TOYS FOR THE POOL

- (A) Vinyl Float - Has vinyl cast-in and is built for 2-3 people. Pr. 1.49
- (B) Big 36 Inch Tire Tube Ring - Has 6 tie-downs. Pr. 1.99
- (C) 24 Inch Diameter Inflatable Swim Ring - Has 2 tie-downs. Pr. 1.99
- (D) High Flying Float - Has 2 tie-downs. Pr. 3.29
- (E) 16 Inch Swim Ring or 22 Inch Surf Board - Has 2 tie-downs. Each 1.19
- (F) Ball and Swim Ring Set - Pr. .99
- (G) Inflatable Arm Floats - Pr. .69

*Let W.A. help you get  
Ready for summer fun!*



## SWIM ACCESSORIES

- (A) Swim Fins - Pr. 3.99
- Swim Fins - Pr. 4.99
- Swim Fins - Pr. 5.99
- (B) Mask & Snorkel Set - Pr. 3.59
- Adult Mask & Snorkel Set - Pr. 5.39
- (C) Nose Clip - Pr. .69
- (D) Ear Plugs - Pr. .49

W.A.!

Get your own  
W.A.!



## SAVE ON SIX-RIDE GYM SET

Includes 6 slides, 2 trapezes, 2 Astroturf Swing seats, 2 low swing seats, 100 lbs. of sand and 6 tie-downs. W.A.!

# 89<sup>99</sup>

Ground Anchor Stake Set - 4 tie-downs, 4 tie-downs, 4 tie-downs, 4 tie-downs. Pr. 6.99



## SAVE ON GYM SET

# 59<sup>99</sup>

## SAVE ON 6-LEG GYM SET

# 119<sup>99</sup>



SAVE 5.00!  
ALL-IN-ONE  
PLAY CENTER

# 64<sup>99</sup>

## Use Convenient Credit!

FINANCING TERMS: WESTERN AUTO

# Get Spectacular Savings

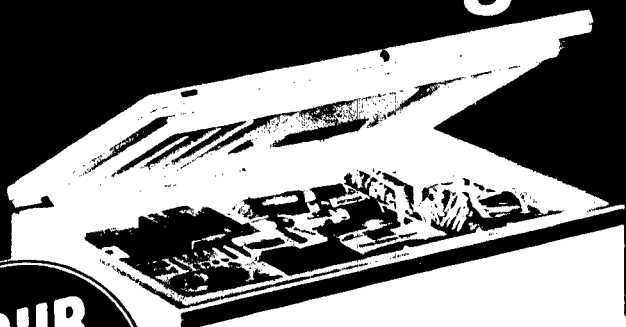

**YOUR CHOICE**

**15.3 CU. FT. CHEST or  
13.2 CU. FT. UPRIGHT FREEZER**

**Look! You Save up to \$60!** **299<sup>99</sup>** EACH

Regular to 359.99

Both with child-safe, pop-out keyed locks textured aluminum finish

**20.3 CU. FT. CHEST FREEZER HOLDS UP TO 710 LBS** **42999**

2 baskets, 2 dividers, drain light 84-1820-4

**25.3 CU. FT. CHEST FREEZER HOLDS UP TO 885 LBS** **48999**

2 baskets, 2 dividers, drain light 84-1825-3

**EXTRA BASKET FOR THESE CHEST FREEZERS 54-1500-5 5 89**

**EXTRA FOOTED DIVIDER FOR THESE CHEST FREEZERS 54-1501-3 5 89**

**13.2 CU. FT. UPRIGHT FREEZER HOLDS UP TO 455 LBS** **34999**

4 aluminum shelves, defrost drain 84-3913-5

- Chest freezer holds up to 536 lbs. of frozen foods
- Upright freezer holds up to 462 lbs. of frozen foods
- Chest freezer has 2 sliding baskets plus adjustable divider
- Upright freezer has full-width interior and door shelves
- Both feature automatic zero temperature control

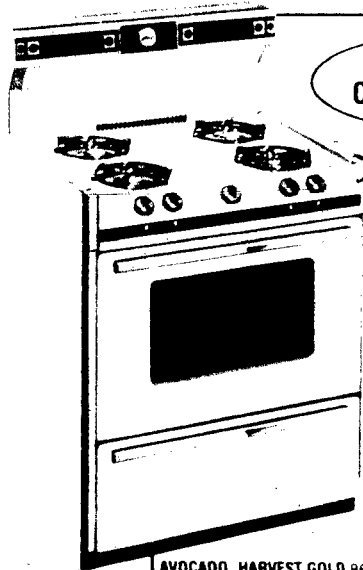

**CONTINUOUS  
CLEANING OVEN**

**Save \$20 on  
Your Choice!  
30" GAS or  
ELECTRIC RANGE**

**349<sup>99</sup>** EACH  
White

Regular 369.99

- Chromed backguard with clock light & timer
- Gas range has fuel-saver spark ignition
- Electric range has bottom storage drawer

AVOCADO, HARVEST GOLD 86-6842 43 7842 43 ONLY \$10 MORE

## SHARP AUTO-TOUCH MICROWAVE

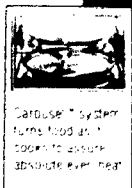
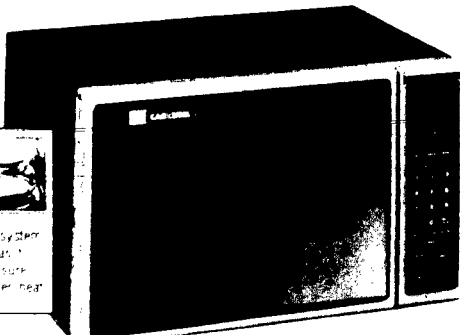

Carousel™ system turns food as it cooks to assure absolute even heat

**You Save \$50!**

**399<sup>99</sup>**

Regular 449.99

**BEST SHARP CAROUSEL HAS TEMP PROBE 86-4395-9 559 99**

**WALNUT-LOOK MICROWAVE OVEN CART w/ CABINET 86-4365-2 37 99**

# On Freezers Now At W.A.!



**Save  
30.00**

**USE YOUR  
CREDIT!**

## 15.3 CU. FT. CHEST FREEZER

Regular 319.99 Value!  
Save on Food Bills!  
Stock Up When Food  
Prices are Low!

**289<sup>99</sup>**

...the most popular chest freezer in the market today. It's the only chest freezer with a built-in defrost timer. It's the only chest freezer with a built-in defrost timer. It's the only chest freezer with a built-in defrost timer.

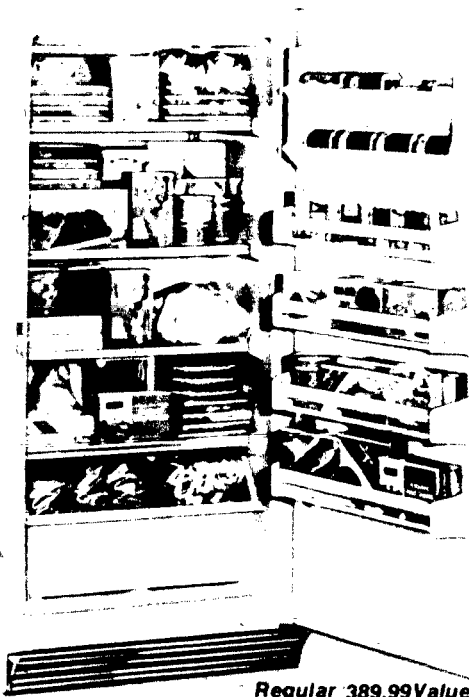

Regular 389.99 Value

## Save 50.00! 15.8 CU. FT. UPRIGHT FREEZER

Convenient upright stores up to 553 lbs. Has 4 aluminum shelves (1 lift-out), slide out storage drawer. Door has 4 shelves, 2 juice can shelves. Thrift Temp. system maintains constant 0 F.

**339<sup>99</sup>**

White  
44 1/2" H

18.0 Cu. Ft. Freezer 84-3918-4 429.99 15.8 Cu. Ft. No-Frost Freezer 84-4916-4 479.99

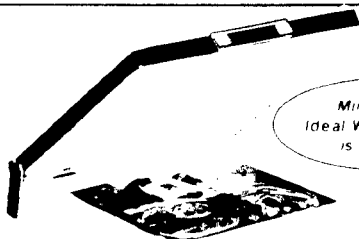

Mini Unit is  
Ideal Where Space  
is Limited



Your W.A. dealer may not stock all major appliances, but most are available from his nearby distribution center. He can tell you in minutes whether the appliance you want is in stock and when you can expect to get it!

**Save  
20.00  
Now!**

## 5.1 CU. FT. COMPACT FREEZER

Regular 239.99 Value! Holds 178 lbs. High-density non-settling fiberglass walls. Interior surrounded by cooling coils.

**219<sup>99</sup>**

White  
31 1/2" H

8.2 Cu. Ft. Chest Freezer, Holds 288 lbs. 84-1808-9 249.99  
WESTERN AUTO 25

# HERE'S VALUE,



**Save \$40**  
**14 CU. FT. NO FROST**  
**REFRIGERATOR/FREEZER**  
*With Textured Steel Door!*

**449<sup>99</sup>**  
White

*Regular 489.99 Value!*

*So convenient—never needs defrosting*

*Separate controls for each section*

*Refrigerator section has 4 full-width shelves (3 slide out), 2 crispers, meat keeper, Door has 2 shelves, egg rack, and covered dairy compartment.*

*Freezer features full-width shelf, door shelf plus ice cube trays*

*Choose Gold or Almond 83-7914 9914 \$10 More!*

**Use Your Credit!**

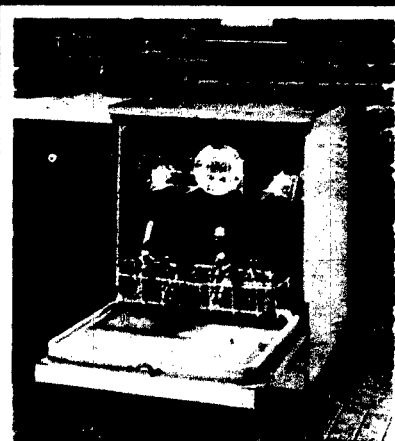

**19 CU. FT. SIDE-BY-SIDE NO FROST**  
*Reg. 699.99—This refrigerator/freezer has separate cold controls. Easy-roll. Almond, Gold, Avocado*  
**649<sup>99</sup>**  
*83-5831 7831.9831 \$10 More!*  
*Automatic Ice maker 54-1511-2 84.95*

**STANDARD 12 CU. FT. REFRIGERATOR**  
*Reg. 319.99—Single-door with 3 shelves covered crisper, 2 door shelves, egg racks and covered dairy compartment provide plenty of storage area. SAVE!*  
**289<sup>99</sup>**

**Save '20**  
**PORTABLE DISHWASHER**  
*Regular 309.99 Value! Buy today for only*  
**289<sup>99</sup>**  
*Hardwood cutting board top and casters. Cleans 12 14 place settings. Saves time Harvest, Almond*  
*85-5853 54 Only \$10 More!*  
*Built-in Dishwasher Colors available! 85-5890-0 249.99*



# SELECTION & QUALITY YOU WANT!



LOOK! OUR BIG 19 CU. FT. NO-FROST COMBINATION

**Price Cut \$100**

Reg. 619.99 - Adjustable shelves, 2 meat slicers and meat keeper, Reversible doors, 83-1719-0 Avocado, Harv. Gold, Almond 83-5214-0 7719-9719

Automatic Icemaker Kit 54-1503-9 \$10 More

**519<sup>99</sup>**

White

Just 84.95

ECONOMICAL 14.4 CU. FT. NO-FROST COMBINATION

**389<sup>99</sup>**

White

Has 10 cu. ft. Thrifty Dehumidifier, 2 meat slicers, 2 meat keepers, well designed with plenty of storage space, reversible doors, separate cold controls, textured steel doors.

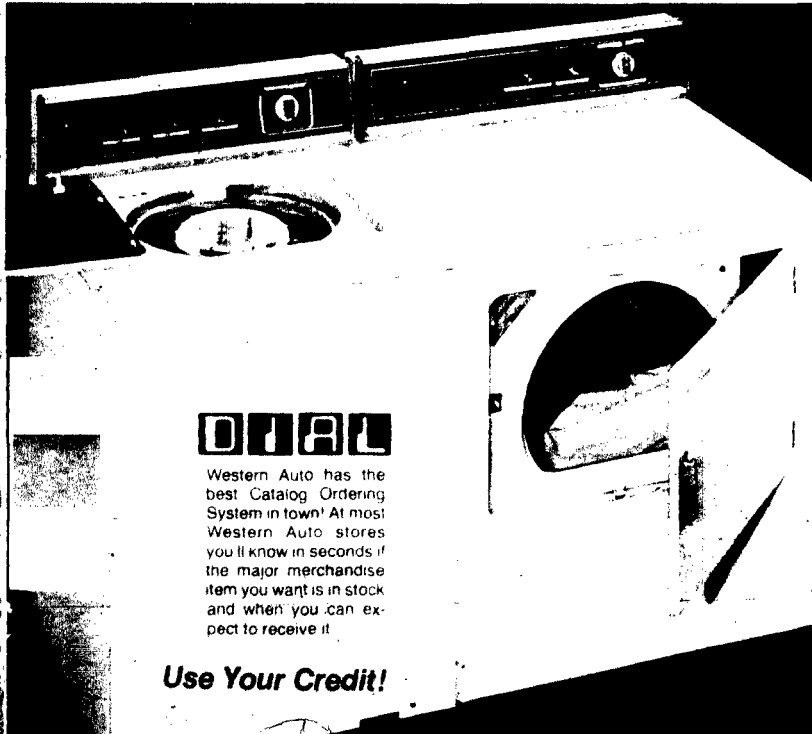

**DIAL**

Western Auto has the best Catalog Ordering System in town! At most Western Auto stores you'll know in seconds if the major merchandise item you want is in stock and when you can expect to receive it.

**Use Your Credit!**

**Save \$80 on a Laundry Pair!**

THIS BIG 20-LB. CAPACITY AUTOMATIC WASHER—

Cut \$40 to.. **319<sup>99</sup>**

White

THIS BIG 20-LB. CAPACITY ELECTRIC DRYER—

Cut \$40 to.. **239<sup>99</sup>**

White

White Gas Dryer 85-3961-0 Cut \$40 Now to Just 279.99

Choose Almond, Harvest Gold or Avocado for Only \$10 More!

8-Ft. Dryer Vent Kit 85-9223-0 7.99

# Save on a New Sewing Machine!

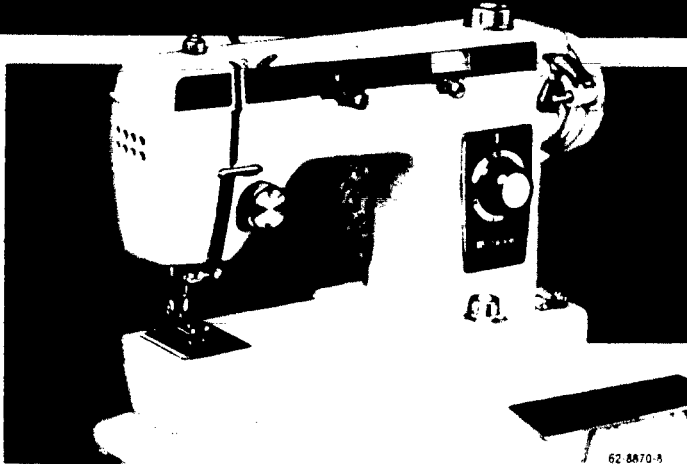

**CITATION FREE ARM ZIG ZAG 17999**

Convertible! Includes snap-on flat bed attachment. Built-in buttonholer.

OUR BEST FREE ARM/FLAT BED ZIG ZAG 62-8852-5 259.99  
PORTABLE SEWING MACHINE CASE 62-8882-3 19.99



**Cut '20**  
**ZIG ZAG SEWING ONLY 9999**  
62-8846-8  
Regular 119.99 Value! Sews buttons, buttonholes, stretch stitch. Includes accessory kit, light WALNUT FINISH CABINET 62-8874-0 ONLY 59.99



62-8870-5  
**4499**  
2-IN-1 FREE ARM/FLAT BED SEWING TABLE

Save 3.96  
**PRO-TYPE DRYER & STYLER**

2 term. deliveries. 1200 watt  
**1699**  
Includes Concentrator!  
Reg 20.95

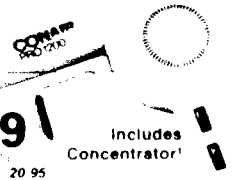

Save \$5  
**4 QT. ICE CREAM FREEZER**  
Reg. 21.99 Value  
Wood tub  
**1699**  
4-QT. ELECTRIC  
49-1109-5 28.99

Regular 33.99  
**TEFLON GRIDDLE/WARMER**  
Cast aluminum with plug-in control  
**2899**

Regular 18.99  
**COPAL L.E.D. ALARM CLOCK**  
24 hr. memory alarm  
10 minute snooze  
**1499**

**Look! Cut \$7**  
**WEAR-EVER® CHICKEN BUCKET**  
Reg. 34.99  
**2799**  
Fry "Carry-Out Style" at Home  
Speed-fries in minutes. For vegetables and seafood too. 6-qt.

Regular 16.99  
3 1/2 qt.  
2-temp.  
**WEAR-EVER® POKEY-POT**  
**1499**  
RIVAL 5-QT CROCK POT 2-temp with cord 49-1213-5 27.99

Save 2.50  
**2-SLICE TOASTER**  
**1299**  
Reg 15.49  
**4-SLICE TOASTER**  
49-2111-0 25.99

Save \$10  
**MR. COFFEE WITH COFFEE SAVER**  
**2999**  
Reg 39.99  
CARAFE 57-2301-0 5.49

**BIC DISPOSABLE BUTANE LIGHTER**  
Reg. 69c  
56-2706-1  
**59c**

**CHECK OUR LOW PRICES ON EVEREADY BATTERIES!**

- 9-Volt Transistor Batteries. Radios, calculators 28-6010-4 Pkg 2 1.19
- Standard "D" Cells 28-6013-8 Pkg 2 69c
- Standard "C" Cells 28-6014-6 Pkg 2 69c
- Standard "AA" Cells 28-6015-3 Pkg 2 59c
- 9-V. Heavy Duty Batt. 28-6100-3 Ea 1.09
- Heavy Duty "D" Cells 28-6120-1 Pkg 2 79c
- Heavy Duty "C" Cells 28-6110-2 Pkg 2 79c
- 6-V. Heavy Duty Lantern 28-6130-0 2.77
- 9-V. Alkaline Batt. 28-6260-5 Ea 1.59
- Alkaline "D" Cells 28-6250-6 Pkg 2 1.69
- Alkaline "C" Cells 28-6240-7 Pkg 2 1.69
- Alkaline "AA" Cells 28-6230-8 Pkg 2 1.39
- 6-V. Lighting Battery. Screw terminal type 28-8916-0 Ea 2.39
- 6-V. Lantern Battery. Spring terminal type 29-8917-8 Ea 2.19

**FURNACE FILTERS**  
16x20 16x25  
20x20 14x25  
10x20 15x20  
14x20  
**69c** EA  
20x25 Filter 57-2203-B - Row 75c

Save 2.50  
**24-HR LAMP & APPLIANCE TIMER**  
**999**  
Reg 12.49

# CLEAN UP WITH SUMMER SAVINGS AT W.A.



10 GAL. WET/DRY  
POW-R-VAC

Regular 79.99 **64.99**  
 Over 100 uses for  
 home shops, garages, cars, boats, lawns &  
 more. Picks up water.  
 5 Gallon Model Attachment, see #105-1 44.99

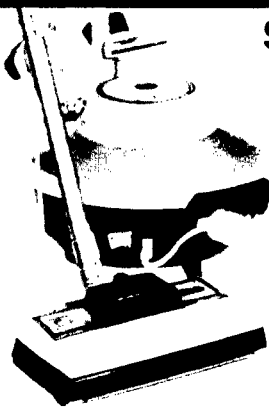

Save  
\$20

DELUXE TWIN-POWER VACUUM

Reg. 169.99 **149.99**  
 14.5" motor, 10' extension tube with  
 4 attachments. Western Auto  
 has the right price for you. Call 1-800-4-A-1-1



VACUUM BAGS

99¢



Save \$5  
ELECTRIC  
BROOM

**34.99**

Regular 39.99!  
 Molded handle  
 2-speed selector  
 Rug and floor  
 nozzle

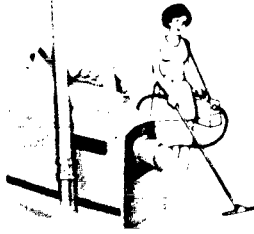

SUPER PORTA-VAC

**49.99**

11" and 21" port vac.  
 With carry strap and motor



Save \$5  
1 1/2 H.P. VAC  
WITH TOOL PAK

Reg. 69.99 **64.99**

Shag groomer deep  
 cleans rugs beauti-  
 fully. Includes all the  
 tools you'll need.  
 Stands on end to store.

CHOOSE 3 TRAYS  
OR DECANTER

Values to  
90¢

**59¢**

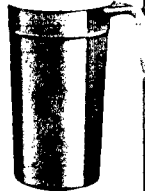

## YOUR CHOICE

## YOUR CHOICE

## YOUR CHOICE

## YOUR CHOICE



48 QT. WASTEBASKET  
OR DISH DRAINER SET

Regular up to  
2.59!

Choose either  
for only

**1.99**

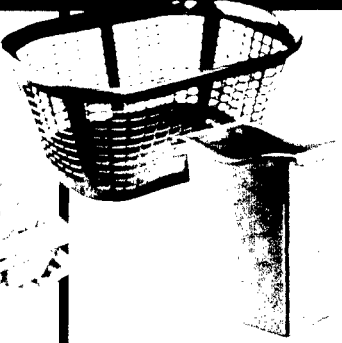

LAUNDRY BASKET OR  
28 QT. WASTEBASKET

Regular up to  
1.99!

Choose either  
laundry basket

**1.59**

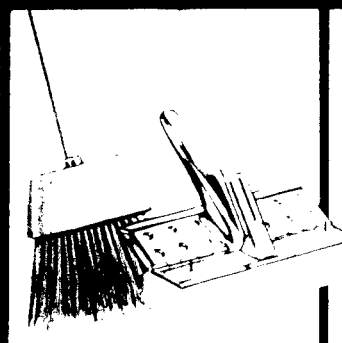

SPLIT TIP BROOM  
OR SPONGE MOP

Regular up  
to 2.49!

Save with  
this SAVE

**1.99**

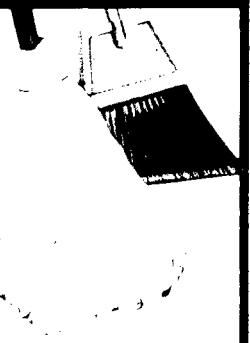

ANGLE CUT BROOM OR  
YARN WET MOP

Regular up to  
2.09!

Choose either  
Straight handles

**1.59**

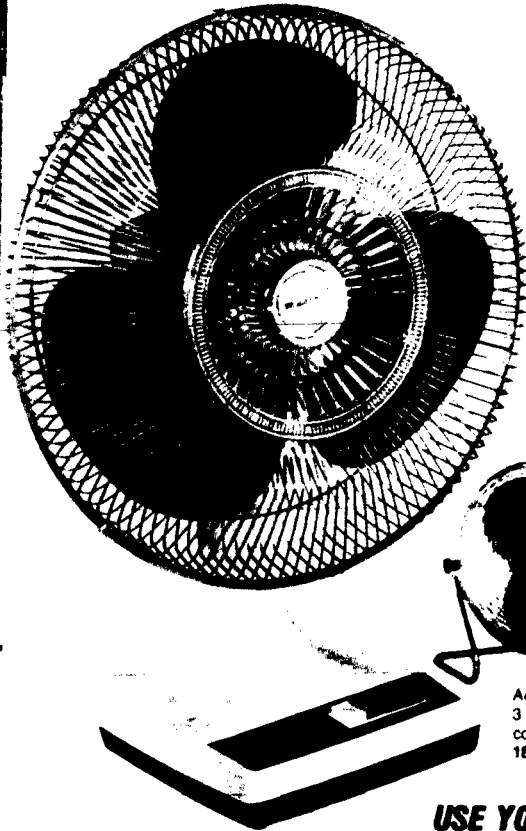

**Save \$5**  
**3-SPEED**  
**16 IN. FAN**  
**44.99**

**Regular 49.99!**  
 Oscillates a full 90°. Provides maximum cooling and air movement with little energy consumption. Push-button controls, super quiet.



**Save \$5 Now!**  
**20" ROLL-ABOUT**  
**Regular 39.99**  
**Value! 34.99**

2-speed fan flips over to exhaust hot stale air.



**2-SPEED FAN**  
**Regular 27.99**  
**Quiet running 22.99**  
 20 inch fan  
**3-Spd. Fan 26.99** 26.99



**20 WINDOW FAN**  
**Regular 77.99**  
**2 spd. high low exhaust 64.99**  
 4 high low intake 120°

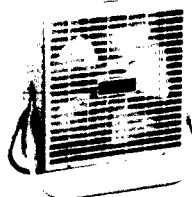

**12 COMPACT FAN**  
**Regular 20.99**  
**Pivotal 2-speed fan 17.99**  
 Weighs only 3 lbs.



**Save \$10**  
**HI-VELOCITY**  
**12 IN. FAN**  
**39.99**  
 Reg. 49.99  
**3-speed, sends cool breezes 360°**  
 Aero-direction stand tilts. Cools with 3 times the amount of air delivery of comparable size fans!  
**18 in. Model 55-2711-4 59.99**

**USE YOUR CREDIT TO BUY A NEW BARBECUE GRILL!**

**Save \$40!**  
**LP GAS GRILL**  
**Regular 139.99**  
**Value! 99.99**

Cast aluminum bottom and top. Stainless steel burner. Adjustable flame. 20 lb LP gas tank, permanent volcanic rock cooks evenly. 13 1/2 x 19 1/2 in. Chromed steel grates. Elec. Motor/Spit 43-1520-6 24.99



**Deluxe CHAR-BROIL Kettle**  
**Reg. 59.99 Value! 49.99**  
 43-1340-9



**BARREL-TYPE SMOKER GRILL**  
**Regular 21.99 Value! 17.88**  
 43-1075-1

**Save 10.11!**  
**SMOKER GRILL**  
**Reg. 44.99**  
**34.88**

19 1/2 x 18 1/2 in. cooking grid  
**Deluxe Smoker Grill 49.99**  
 43-1080-1

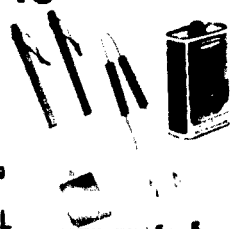

**LIGHTER FLUID**  
**Reg. 1.09**  
**79¢**  
 43-2791-1

**BBQ TOOL SET**  
**Reg. 3.99**  
**2.99**  
 43-3900-7



**24 IN. BRAZIER GRILL**  
**Regular 14.99!**  
**9.99**  
 Tubular aluminum legs remove for storage. 4 position chromed grid. Heated Brazier 43-1053-8 18.68

**ANY ITEM NOT IN STOCK IS QUICKLY AVAILABLE!**



# Every Air Conditioner on Sale!

As Seen on  
**TV**



High Efficiency "Energy Saver"  
12,800 BTU AIR CONDITIONER

Save \$50!

**399<sup>99</sup>**

Regular 449.99 Value!

Power saver design gives a D O E EER of 8.8. Power exhaust system and adjustable humidity control pull warm inside air out. Automatic thermostat, 3-speed fan, adjustable louvers. Expanding panels for light fit.

16,200 BTU Multi-Room Air Conditioner. 230 208 volt. 82-3916-2 449.99

21,250 BTU Multi-Room Air Conditioner. 230 208 volt. 82-3920-4 559.99

All Citation Air Conditioners carry a D O E (Department of Energy) EER (Energy Efficiency Ratio) rating. Models: 82-3888, 3184, 3585, 3617, 3629, 8832 are NOT available in California, Minnesota, New York, New Jersey.

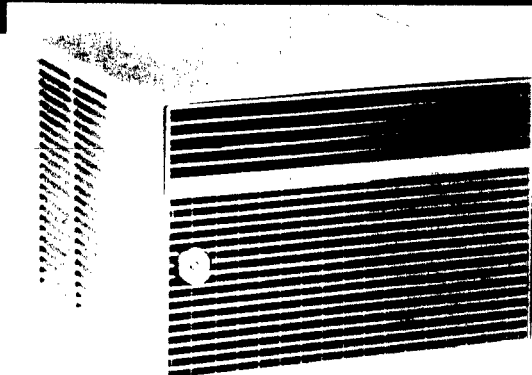

LOW COST ROOM COOLING —  
4,900 BTU AIR CONDITIONER

**169<sup>99</sup>**

Regular 199.99 Value!

4,900 BTU Thermostat, Expanding Panels. 115 V. H. 3000 219.99

7,900 BTU Thermostat, Expanding Panels. 115 V. H. 3100 279.99

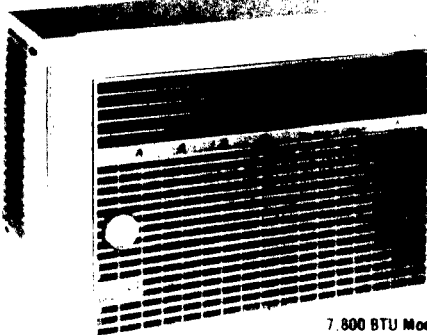

"Energy Saver"  
5,900 BTU AIR  
CONDITIONER

**269<sup>99</sup>**

Regular 289.99

Power exhaust fan, adjustable humidity control, and 3 speed fan. Expanding panels for a tight seal.

7,800 BTU Model 82-3908 329.99  
11,700 BTU "Energy Saver" 82-3910 349.99

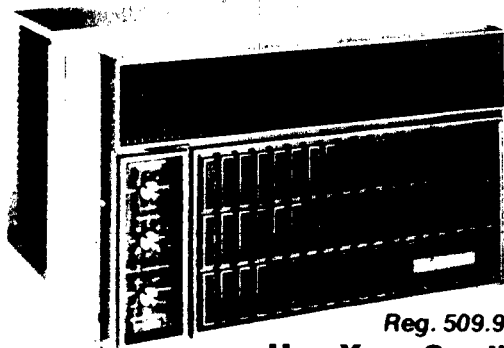

19,900 BTU "ENERGY  
SAVER" MULTI-ROOM AIR  
CONDITIONER

**449<sup>99</sup>**

Reg. 509.99

Use Your Credit

16,000 BTU Multi-Room Unit. 230-208 Volt 82-3517-8 389.99  
24,600 BTU Multi-Room Unit. 230 Volt 82-3524-4 549.99  
28,050 BTU Multi-Room Unit. 230 Volt 82-3928-7 699.99

2-SPEED, 4200  
CFM EVAPORATIVE  
WINDOW COOLER

**299<sup>99</sup>**

BUDGET 2-SPEED  
4000 CFM  
WINDOW COOLER

**284<sup>99</sup>**

Deluxe 2-Speed  
4400 CFM Unit  
55-4117-2 339.99

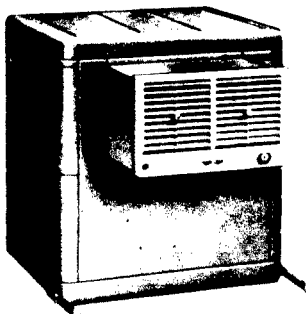

MOBILE HOME /  
SMALL HOME  
AIR CONDITIONER

32,000  
BTU  
230 Volt

**699<sup>99</sup>**

Cold Air Duct System  
for Mobil Homes.

54-1597-1 129.99

PHOTO AND TERMS  
OPTIMIZED FOR DEALER

# Enjoy Summer Breezes on New Redwood Furniture!

**USE  
YOUR CREDIT!**



**Save UP TO 7.00**  
**REDWOOD & ALUMINUM**  
**PATIO FURNITURE**

AS LOW AS **13<sup>99</sup>** Serv. Cart

Start your patio furniture shopping here. We have the most complete selection of redwood and aluminum patio furniture in the area. Our prices are so low you can't believe it. We have everything you need for your patio, including: chairs, settees, rockers, chaises, and serving carts. We also have matching gliders and porch swings. Call today to reserve your furniture.

- Reg 18 99 Chair ..... 16 99
- Reg 36 99 Settee ..... 29 99
- Reg 24 99 Rocker ..... 21 99
- Reg 34 99 Chaise ..... 29 99
- Reg 15 99 Serv. Cart ..... 13 99



**Save 5.00 Now!**  
**3 PC. REDWOOD SET**

Reg 79 99!  
Set Includes  
Table & Two  
Benches! **74<sup>99</sup>**

Each piece is made of solid redwood and is built to last. The table is 24" high and the benches are 18" high. The set is perfect for a small patio or deck. Call today to reserve yours.

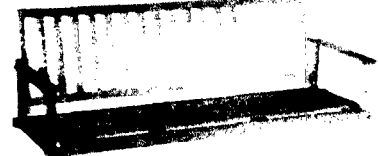

**Save 5.00! PORCH SWING**

Reg 43 99!  
Matching Glider **38<sup>99</sup>** 56 99

## Get the Baby Furniture You Want at W.A. & Save!

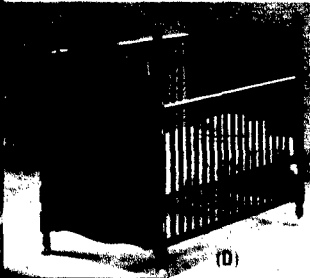

(D)

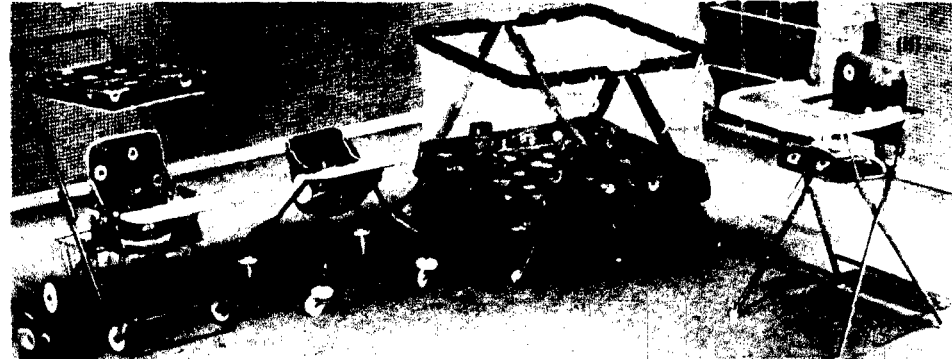

**(A) BABY CARRIER**  
Regular 15.99  
Value! **14<sup>99</sup>**

**(B) HOOLA COUPE**  
Regular 15.99  
Value! **14<sup>99</sup>**

**(C) BOOSTER SEAT**  
Regular 8.99  
Value! **7.99**

**(D) OUR FINEST CRIB**  
Reg 159.99  
Foam Matt. 13.99  
Innerspring Matt. 19.99

**(E) CANOPY STROLLER**  
Regular 29.99  
Value! **26<sup>99</sup>**

**(F) WALKER JUMPER**  
Regular 13.99  
Value! **11<sup>99</sup>**

**(G) PLAY YARD**  
Regular 42.99  
Value! **36<sup>99</sup>**

**(H) HIGH CHAIR**  
Regular 28.99  
Value! **24<sup>99</sup>**

# Easy Summertime Living, Use Your Credit at W.A.

**W.A.**



Western Auto has the best catalog Ordering System in town. At most W.A. stores you will know in minutes if the major item you want is in stock & when you can receive it.



## 2 CHAIRS, TABLE & CHOICE OF SETTEE OR CHAISE!

Foam filled cushions covered in durable vinyl. Redwood frames. Our very best!

Regular 154.99 Value at Western Auto

Save 15.00  
**139<sup>99</sup>**



## COMFORT CONTOURED STEEL SPRING CHAIR 17<sup>99</sup>

Table steel arms. Single weather-resistant fabric.  
Spring Rocker 52-6552-7 18.99 42 Enamelled Table 52-6552-8 29.99  
2-Seater Glider 52-6554-1 49.99 71 1/2 Ft. Umbrella 52-6554-2 32.99  
Special Umbrella Stand 52-6554-3 5.99

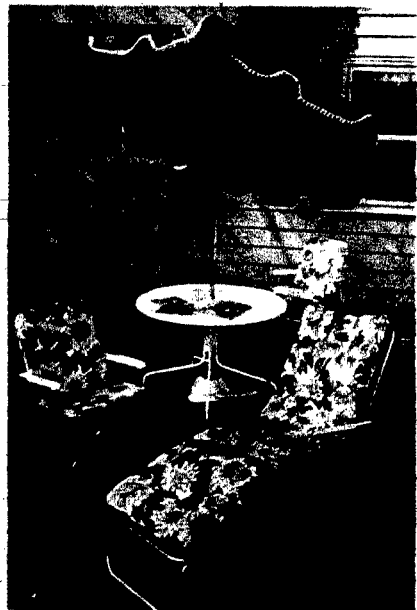

## FOAM PADDED CHAIR 19<sup>99</sup>

Floral vinyl covered cushions  
Comfortable molded arm rests  
72" Foam Padded 3-Pos. Chaise 52-6462-7 32.99

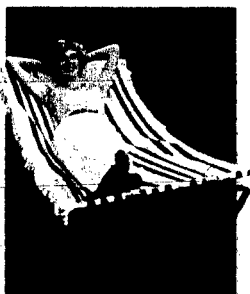

Save 5.00  
CANVAS  
HAMMOCK  
**24<sup>99</sup>**

Reg. 29.99

34x76 with a  
tilt-resisting  
steel frame



## CHILD SIZE-BUT JUST LIKE THE GROWNUPS

Aluminum Chaise Reg. 10.99 **8<sup>99</sup>**  
Aluminum Chair Reg. 7.49 **6<sup>99</sup>**  
Value

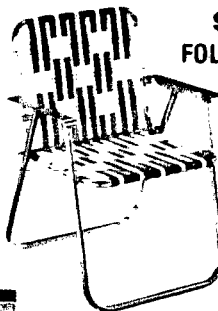

## Save 2.00 FOLDING LAWN CHAIR

**6<sup>99</sup>**

Reg. 8.99

Polypropylene  
webbing  
48" Clamp-On  
Sun Umbrella  
52-6005-4 4.99  
Folding Chair  
52-6210-0 6.99

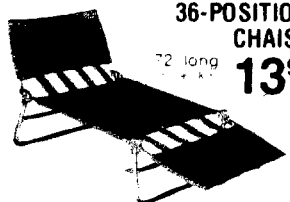

## 36-POSITION CHAISE

72" long  
**13<sup>99</sup>**



## 3x5' FLAG-SET

Reg. 7.79 **5<sup>49</sup>**

With pole & wall mount  
bracket 66-4300-1



## SAVE ON WEBBING!

72 ft polypropylene or  
38 ft polymer in bright  
colors 52-6011-17 **1<sup>59</sup>**  
Each

20 Screws/Grommets 52-6004-7 55c

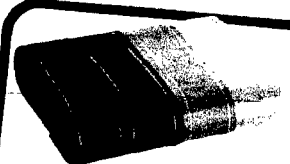

CHAIR WEBBING **39<sup>c</sup>**

PRICES AND TERMS  
OPTIONAL WITH DEALER. WESTERN AUTO 33

# Save Now on These Contemporary Styles



## Save 80.00 7 PC. DINETTE SET

Regular 219.99 Value!

**139<sup>99</sup>**

A beautiful butcher block-look set with saddle gold leather-look vinyl chairs! Chrome chair and table legs brightly complement the wood-like tones of the Formica\* laminated table top. 36x48 in. table. 60 in. with leaf.

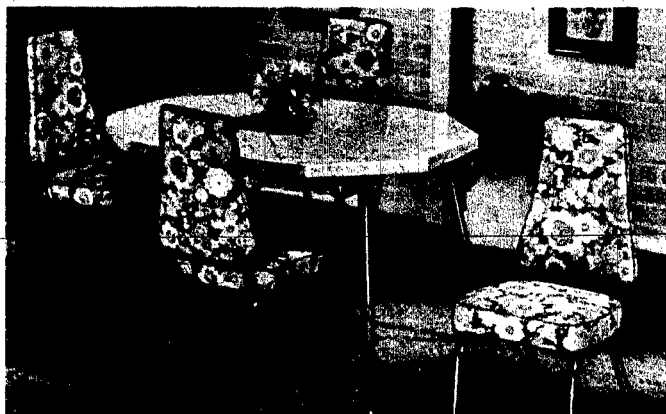

## Save 70.00 on 5 PC. FLORAL DINETTE SET

Regular 169.99 Value! Use Your Credit!

**99<sup>99</sup>**

Octagonal dining table with lime Formica\* top is 36x48 in. Comfortable high-back chairs are covered in light and dark avocado floral pattern with white accents. Carefree Formica\* laminated table top and vinyl chair coverings. 3 in. padded seats and backs. enameled tube steel legs.

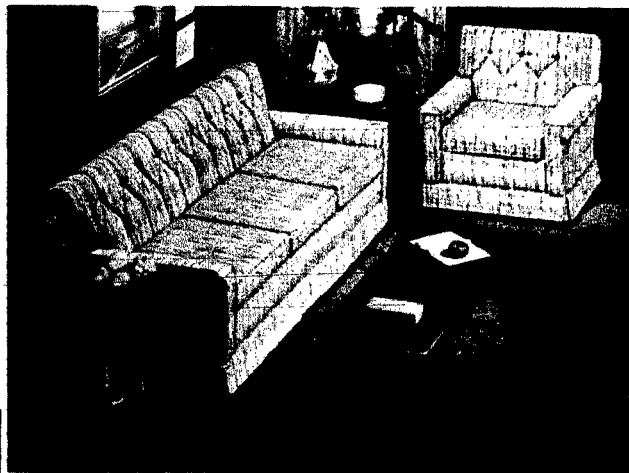

## Save 50.00 Now!

### 79 IN. HERCULON® SOFA

Regular  
249.99  
Value!

**199<sup>99</sup>**

Traditional styling in popular rust beige nutmeg tweed Herculon® upholstery. Button tufted backs and pleated skirts. Deep 5 in. seat and 4 in. back cushions. Tied no-sag springs.

Reg. 159.99 . Matching Chair 56-2651-0 129.99  
Reg. 36.99 . End Table 56-8287-7 32.99  
Reg. 36.99 . Cocktail Table 56-8286-9 32.99  
Reg. 29.99 . Glass Swag Lamp 56-3634-5 26.99  
Reg. 84.99 . 9x12 ft. Rug 56-6125-28 74.99  
Reg. 139.99 . 12x15 ft. Rug 56-6129-32 124.99

**DIAL**



Your Western Auto dealer may not stock all furniture items, but most are available from his nearby distribution center. He can tell you quickly when you can expect your item.



## Save 40.00 Now!

### 88" MODERN SOFA

**159<sup>99</sup>**

Regular 199.99 Value!

Rich, warm Herculon® plaid with accent straps of brown leather-look vinyl. Plus 4 in. seat and 2 in. back foam cushioning. Thick, padded arms. Reinforced oak frame with no-sag springs. Easy-to-fasten.

Matching Chair 56-2906-8 94.99  
58 in. Love Seat 56-2907-6 129.99

**Use Your Credit!**



# BEAUTIFUL SAVINGS ON W.A. FURNITURE

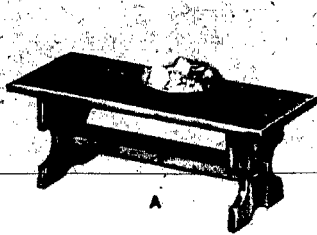

A

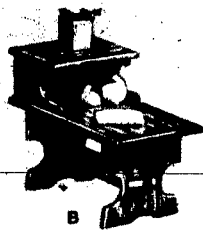

B

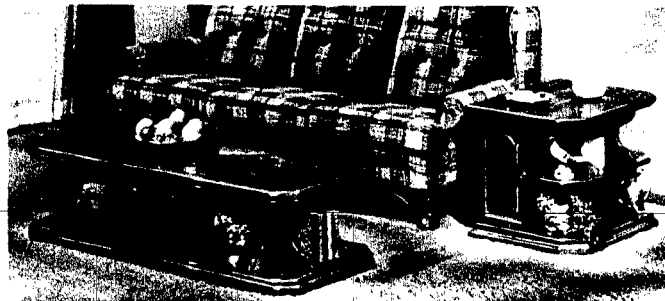

## DIAL

Your Western Auto dealer may not stock all furniture items, but most are available quickly from his nearby distribution center. He can tell you in minutes when you will receive the item you have selected.



C

## BUY SEPARATELY OR IN SETS—SOLID PINE!

(A) Trestle Coffee Table. 42x16". Reg. 82.99 Value! **64<sup>99</sup>**

(B) Trestle Step End Table. 22x30". Reg. 82.99 Value! **59<sup>99</sup>**

(C) Dough Box End Table. 14 1/4 x 25 1/2". Reg. 89.99 Value! **64<sup>99</sup>**

Cabinet Table. Doors on both sides. Brass plated hardware. 60x16" Above. **239<sup>99</sup>**

Cabinet Table. 2 shelves and door. 28x22x21 1/2 inches Above. **159<sup>99</sup>**

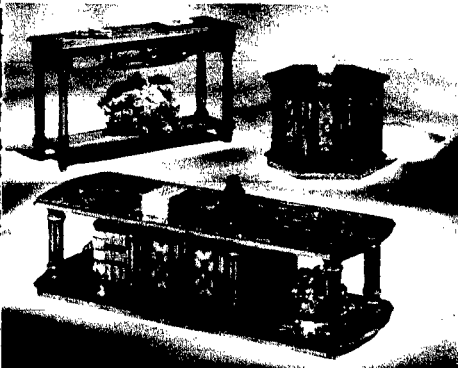

## PECAN-GRAIN PERIOD TABLES

Sofa Table, Shell Regular 129.99. 56-8202-6 109.99  
Hexagonal End Table. Regular 99.99. 56-8205-9 84.99  
Coffee Table, Storage Regular 99.99. 56-8206-7 84.99

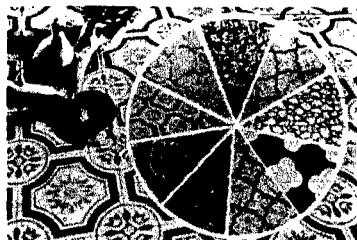

Your home will shine with a bright new look when you redecorate with famous easy-care Armstrong®

## ARMSTRONG® PRINTED RUGS

Regular 25.99 Value! Budget priced and handsome 9x12 ft size printed rugs are easy to wipe clean with a sponge.

**22<sup>99</sup>**

Such an easy, practical way to cover a worn out floor! 12x15 Ft. Armstrong® Printed Rug. 56-6448-59 38.99



## Save \$6 Now! TABLE & CHAIRS

**53<sup>99</sup>**

Regular 59.99! Convenient card table and chairs fold and store when not in use. Table has no-slip black vinyl top. Gold enamel legs & chairs. Padded Folding Chair. Black vinyl seat Gold enamel 56-8109-3Ea 13.99



(A) **MEDITERRANEAN TABLE**  
Reg. 56.99 Value!  
Coffee table has shelf and 2 doors. Storage

**44<sup>99</sup>**



(B) **MEDITERRANEAN HEXAGONAL TABLE**  
Reg. 52.99

**42<sup>99</sup>**

Matches (A) Has one door Rich pecan-grain veneer



(C) **COLONIAL STYLE PINE FINISH TABLE**  
Reg. 82.99

**59<sup>99</sup>**

Coffee table has storage areas. 2 doors and shelf.



(D) **COLONIAL STYLE HEXAGONAL TABLE**  
Reg. 72.99

**59<sup>99</sup>**

Matches (C) End table has one door & storage space



**2-WAY RECLINER**

Reg 169.99 **99<sup>99</sup>**

Green or brown plaid  
Herculon® brown vinyl



**2-WAY KING SIZE**

Reg 279.99 **199<sup>99</sup>**

Gold or rust tweed  
Herculon® brown vinyl



**COUNTRY ROCKER**

Reg 84.99 **64<sup>99</sup>**

Dark green with gold  
floral design

**Look! You Save 50.00  
ROCKER/RECLINER**

Choose Spice Tweed,  
Saddle Brown or Oxblood Vinyl!  
Regular 179.99 Values

**129<sup>99</sup>**  
56-2420  
21.22

**Use  
Your  
Credit!**

Relax and rock in foam cushioned comfort. Stretch out in either of two recliner positions. Strong oak frame and rocker base. Steel recliner mechanism and non-sag springs.



**86 IN. EARLY AMERICAN SOFA**  
**Save 100.00 479<sup>99</sup>**

Regular 579.99

Homespun Quaker Herculon® tweed with warm Honey Pine finish trim. 8" thick cushion.

**Use  
Your  
Credit!**

- Matching Rocker 56-2596 319.99
- 61 In. Love Seat 56-2597 419.99
- 30x24 End Table 56-8226 144.99
- 56 Cocktail Table 56-8225 154.99
- 35 Eagle Lamp 56-1964 36.99
- 9x12 Scul. Rug 56-8125 28 74.99
- 12x15 Rug 56-6129 32 124.99



**DIAL**

Items (but most are available through our nearest distribution center. He will tell you the minutes when you will receive the item you want.



**83 IN. WING BACK EARLY AMERICAN SOFA**  
**Save 90.00—Use Your Credit**

Soft floral pattern Antron® nylon velvet accented with dark pine. Solid hardwood frame.

**299<sup>99</sup>**

- Matching Chair 56-2598 179.99
- 24x20 End Table 56-8226 94.99
- 59 Love Seat 56-2584 249.99
- 58 Cocktail Table 56-8225 94.99
- Queen Size Sleeper 56-2595 459.99

**Save 12.50!**  
**"MILLION AIR"**  
**FOAM BEDDING**

Twin  
 Mattress  
 or  
 Foundation  
**57<sup>49</sup>**  
 EACH

*Regular 69.99 Value!* 5 in. mattress—4 1/2 in. foam & 1/2 in. foam quilt cover. Economical comfort! Wood frame foundation & buffer board. Corner guards.

Choose Full-Size  
 Mattress or  
 Foundation.  
**72<sup>49</sup>**  
 EA  
 54 x 75" size

**Save 10.00!**  
**ARISTO PEDIC**  
**COIL BEDDING**

Twin  
 Mattress  
 or  
 Foundation  
**89<sup>99</sup>**  
 EACH

*Regular 99.99 Value!* Made by a U.S. leader! Double-tempered coils. Foundation has high friction top. Layer to keep mattress in place. Quality built for comfort.

Full Mattress or Foundation.  
 56-1052 53 109.99 ea.  
 Queen Mattress & Foundation Set: 56-1054 81 269.99

**SAVE ON RUGGED, SPACE-SAVING BUNK & HOLLYWOOD BEDS!**



**MAPLE FINISH BUNK BED**  
**249<sup>99</sup>**

*Reg. 279.99!*  
 Solid pine construction. Colonial styling. Pane headboard. 4 in. foam mattress. Bolt-on rails. With ladder. 84x60x40 in.

**Save 30.00**



**359<sup>99</sup>**  
**BUNK BED BOOKCASE**

*Reg. 399.99!*  
 Maple finish. Solid pine. Has bookcase headboard. 4 in. foam mattress with foundation. Bolt-on rails. With ladder. 84x60x40 in.

**Save 40.00**



**HOLLYWOOD BOOKCASE TWIN**  
**229<sup>99</sup>**

**Save 20.00**  
*Regular 249.99*

Maple finish. Full mattress. Box springs.



**Save 79.98**

**3 PC. COLONIAL BEDROOM SUITE**

Bed, Dresser and Mirror  
**319<sup>99</sup>**

*Regular 399.97 Value!* The traditional beauty of Colonial Bed Rooms combined with the practicality of today's furniture. Your maple Bed gives the high quality, authentic look while your Mirror and Bed Chest, dresser chest and night stand keep them from being marred or stained. With Colonial details—antique brass pulls, turned pedestal bases & lathe turned spindles.

- Colonial Style Double Dresser—8 drawers—48x31x17 inches 56-1550 4 169.99
- Mirror, Maple Finish Frame—Plate glass—38x30 in. high 56-1554 7 59.99
- Maple Finish Bed, Spring and headboard—54 in. wide 56-1551 4 109.99
- Chest, 30x42x17 in. deep 56-1551 3 119.99
- Night Stand, Drawer 56-1552 7 59.99
- Hurricane Lamp 56-3515 6 24.99
- Desk Lamp 56-3544 6 7.99

Turn on brilliant color . . . sale priced now!

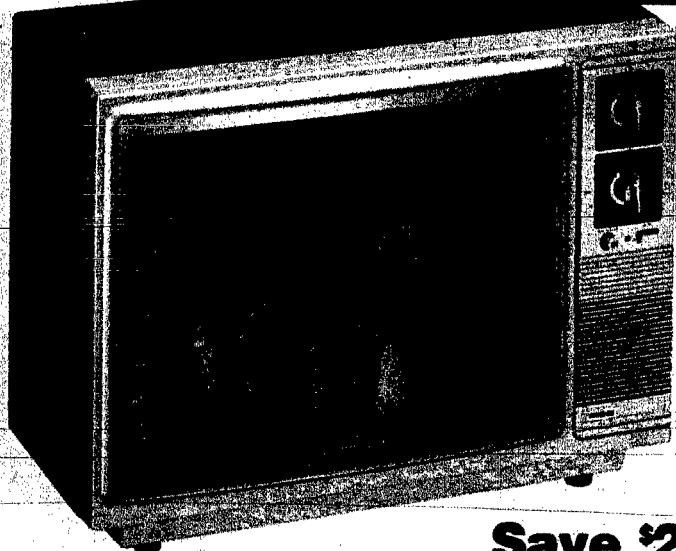

- "Quick-On"  
Vivid  
Color  
Picture
- Automatic  
Fine  
Tuning
- Uses Even  
Less Power  
Than a  
100-Watt  
Light Bulb
- All  
Solid State  
Long Life  
Design

## ENJOY 19" COLOR TV

Full true-to-life color brilliance and clarity thanks to advanced black matrix in-line picture tube. Cool running energy saver chassis, great sounding speaker!

Save \$29.96  
**37999**  
Reg. 409.95  
Value!  
24-4020-4

19" DIAGONAL SCREEN

REGULAR 44.99 WALNUT-LOOK PEDESTAL BASE STAND 24-5486-6 NOW ONLY 39.99

TV Pictures are Simulated

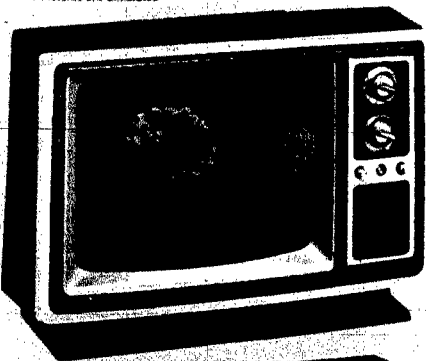

## You Save 39.96 15" COLOR WITH ONE-BUTTON CONTROL

100% Solid  
State Chassis

Uses Less  
Than 100 Watts

**34999**  
Regular  
389.96

15" diagonal screen 24-4915-5

- One button sets light sensor, contrast, color, tint, brightness and AFC
- Slot mask picture tube gives superior picture clarity, sharpness, quality
- Walnut-look molded cabinet

## You Save 49.96 13" LIGHTWEIGHT WITH ONE-BUTTON COLOR.

"Quick-On" 100%  
Solid State

Uses Only  
70 Watts Power

**29999**  
Regular  
349.96

13" diagonal screen 24-4913-0



Western Auto has the best Catalog Ordering System in Town—At most stores you'll know in seconds when you can expect your order



AC/DC 12"  
PORTABLE  
COLOR TV

Save 14.96  
**10999**  
Regular  
124.95



GIANT 25"  
CONSOLE  
COLOR TV

Save 49.96  
**59999**  
Regular  
649.95

25" diagonal screen 24-2979-3

Big, clear, sharp and true to life with advanced black matrix picture tube. 100% solid state.

WESTERN AUTO 38 PRICES AND TERMS  
OPTIONAL WITH DEALER



Regular  
239.99  
Value!

**YOUR  
CHOICE**



Regular  
259.99  
Value!

**FM/AM/FM STEREO  
SYSTEM WITH CASSETTE**

Receiver has lighted slide-rule tuning with indicator, AFC and function switch. Volume, balance, bass and treble controls. Cassette has convenient tape counter. Two microphones are included. BSR changer has ceramic cartridge with diamond stylus, cueing and pressure adjustment. 6 1/2" speakers.

**SAVE  
UP TO  
40.00 NOW!**

**219<sup>99</sup>**  
26-6904 7000

**FM/AM/FM STEREO  
SYSTEM WITH 8-TRACK**

Dual recording meters are standard on this fine stereo system. Volume, balance, bass and treble. Player recorder features automatic or manual program selection, record, pause and program buttons. Fast forward & repeat. Two microphones. 8 speakers. Changer has tinted dust cover.  
**Stereo Cart.** 50 1/2 x 25 3/4 x 16 1/2 in. 26-1504-5 27.99

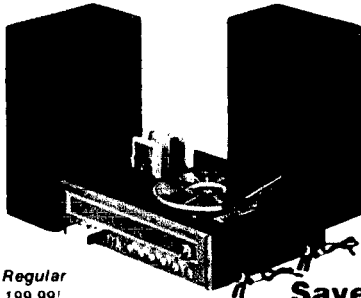

Regular  
199.99!

**Save  
10.00!**

**STEREO  
WITH 8-TRACK RECORDER**

Recording is governed by automatic level control. Lighted slide-rule dials. Has tape storage tray. Built-in AFC. 6 1/2" in. speakers.  
**Stereo Cart.** 21 x 16 1/2 x 21 in. 26-1507-B 22.99

**189<sup>99</sup>**  
26-6700-1



Reg.  
19.95!

**PORTABLE PHONO VALUE**

Top speaker.  
Speed selector.  
12 1/2 x 5 x 10 1/2 inches.  
**18<sup>99</sup>**  
26-6706-1  
Deluxe Phono 26-6504-0 26.95

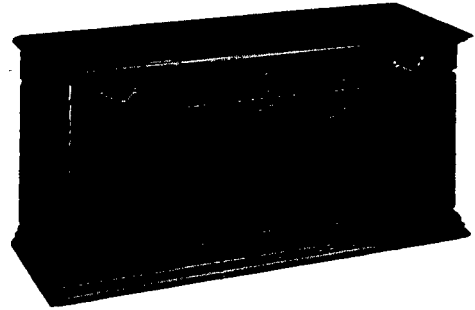

**FM/AM/FM STEREO WITH 8-TRACK**

Country, French, style carrying case with built-in wood finish. Stereo receiver has stereo indicator and slide-type controls. Built-in AFC. 8-track player has program button and auto reverse. Tape storage tray. Two 6 1/2" in. speakers.  
**249<sup>99</sup>**

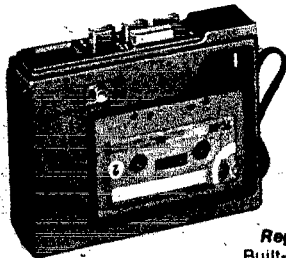

**6x4 INCH  
CASSETTE  
RECORDER**

**35<sup>99</sup>**  
26-7676-5

Regular 44.99 Value!  
Built-in automatic-level microphone. Pushbutton controls. Tape counter and eject button.

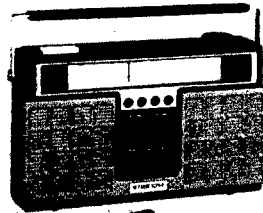

**AC/DC CASSETTE  
TAPE RECORDER**

Reg.  
28.99  
Value  
**24<sup>99</sup>**  
26 7730-0

AC Adapter 26-1580-5 5.99

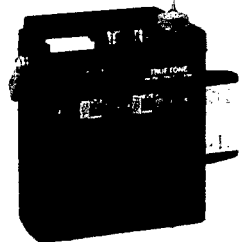

**FM/AM/8-TRACK**

Reg. 52.99!  
Automatic or manual tape program.  
AC/DC or power from car or boat.  
FM antenna. Built-in AFC. Has slide type volume, tone.  
**44<sup>99</sup>**  
26-8600-1



**RECORDING CASSETTE**  
90-minute  
1.49 Value  
**99<sup>c</sup>**  
26 7730-0

60 Minute Memorex 26 7730-0 2.49

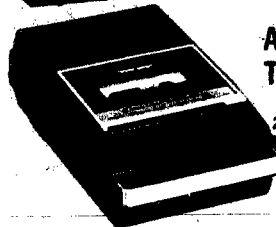

# BLACK &

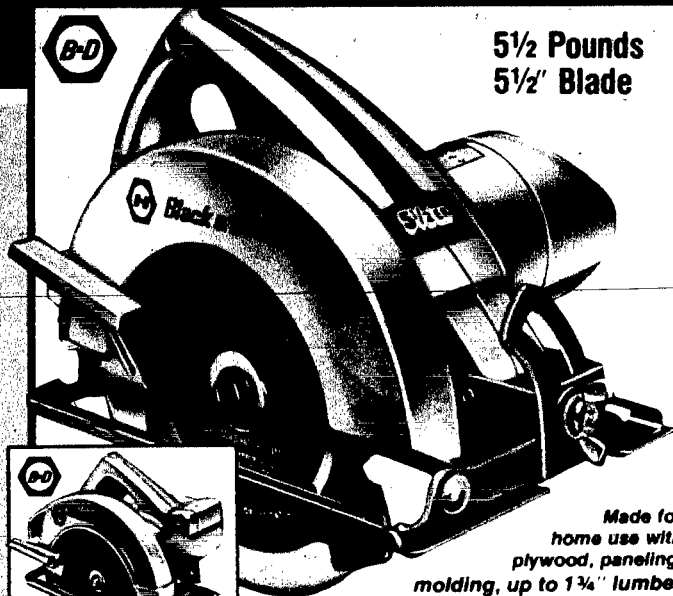

5 1/2 Pounds  
5 1/2" Blade

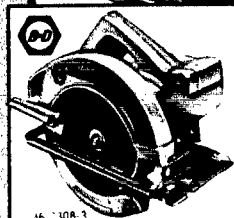

46-1308-3

7 1/4" PORTABLE  
CIRCULAR SAW

1.33 H.P.  
cuts up to  
2 7/8" deep

**2999**

COMPACT SIZE  
CIRCULAR SAW

- Double insulated
- .8 H.P.—4,000 rpm

**2499**

46-1300-0

Complete with combination blade and 6-foot cord

5 1/2-In. Plywood Cutting Blade. 46-2223-9 3.49

7 1/4-In. Plywood Cutting Blade. 46-2218-9 6.29

Made for  
home use with  
plywood, paneling,  
molding, up to 1 3/4" lumber



Drills!  
Drives Screws!  
3/8-INCH REVERSIBLE  
VARIABLE SPEED DRILL

**2599**

46-7190-5

Infinitely variable speed with locking trigger  
switch plus reversing puts you in full control.  
.33 H.P. motor, 6-ft. cord.

Use Your Credit!

13-PC. SET—HIGH SPEED  
STEEL DRILL BITS

- 1/16" to 1/4" sizes by 64's
- Handy molded index case

**699**

45-4627-1

Regular 9.99 Value

ADD A  
SHOWER!  
**1999**

63-1934-1

Get 24x30" frame with  
shower head,  
6' hose, curtain  
Easy to install

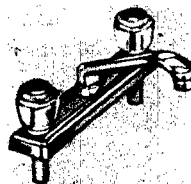

KITCHEN FAUCET

Washerless  
type

Reg 20.99

**1879**

63-1915-4

Reversible Jaw Basin  
Wrench 63-7980-4 7.99

Save 9.00

OUR BEST  
TOOL CHEST  
NOW ONLY

**3499**

45-4689

Regular 43.99

Three deep drawers, 2 1/2" high  
glide open on full suspension slides  
Double wall steel 20 1/2" x 13 1/2" x 8 1/2"

Use Your Credit!

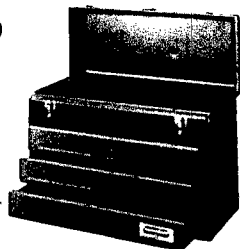

Save \$3  
4-PIECE  
PROPANE TORCH  
SHOP KIT

Regular 15.99

**1299**

45-4476-5

You get burner, two  
propane fuel cylinders  
and sparker



WASHING MACHINE HOSE

Regular 2.59 Value

3/4" by 5 ft. 63-7655-2

**199**

TOILET REPAIR KIT

Regular 9.39 Value

Complete to renew  
tank valve system

**599**



63-7632-1

Save 50¢  
50-FOOT  
POLY BRAID  
ROPE

**169**

Reg 2.19

47-1220-4

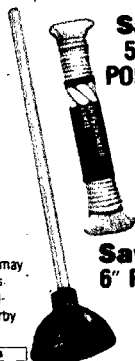

Save 1.30  
6" PLUNGER

**289**

63-7611-5

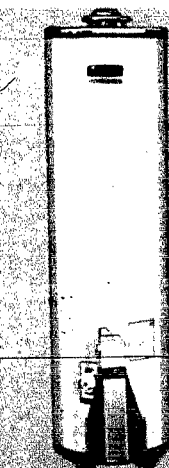

30-GAL WATER HEATER

YOUR CHOICE! Natural Gas  
or LP Type

66-2230-4

66-2231-4

Electric 66-2230-3 118.99

**1299**

WESTERN AUTO 40

Your W.A. dealer may  
not stock all items,  
but most are available  
from his nearby  
distribution center.

WESTERN AUTO 40 PRICES AND TERMS  
OPTIONAL WITH DEALER

# DECKER POWER TOOL SALE

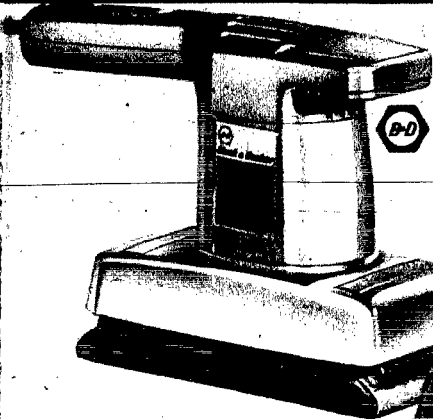

Look!  
ORBITAL SANDER

**25<sup>99</sup>**  
46-7432-1

Fine finishing fast with 1/4 sheet sanding surface. 10,000 orbital strokes per minute!

6-Pc Sandpaper Assortment  
46-2480-5 ..... 95c



VARIABLE  
SPEED  
JIG SAW

**25<sup>99</sup>**  
46-7580-1

0 to 3200 strokes/minute to cut up to 2 inch soft wood

5 Assorted Jig Saw Blades 46-1199-2 1.99

8" RANDOM ORBIT  
POLISHER/SANDER

**39<sup>99</sup>**  
46-7962-7

Won't burn or mar surface! With polish bonnet, 2 foam bonnets, and 3 sander discs!

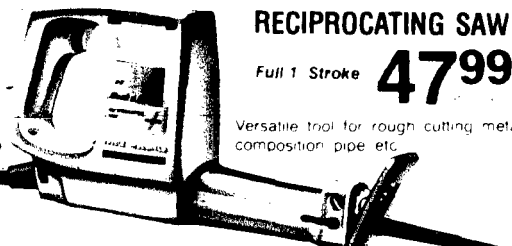
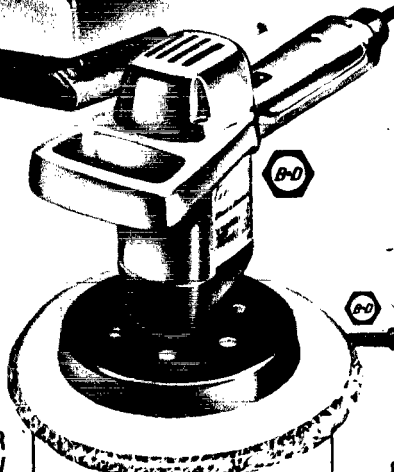

RECIPROCATING SAW

Full 1 Stroke **47<sup>99</sup>**

Versatile tool for rough cutting metal composition pipe etc.



CURVED OR  
RIP CLAW  
HAMMER

Your Choice

**3<sup>99</sup>**  
Each  
Reg. 5.99

16-ounce  
Deluxe Fiberglass  
Handle Hammer.  
45-6136-1 ..... 9.99

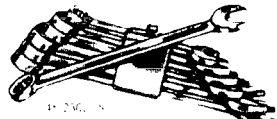

6-PIECE  
WRENCH SET **11<sup>49</sup>**  
Std. or metric EA

8-PC. SCREWDRIVER  
SET ONLY ...

**6<sup>69</sup>**  
Reg. 8.39

Straight  
blade and  
Phillips types  
in pouch

Use Your Credit!



ALL STEEL HIP  
ROOF TOOL BOX

Keeps tools  
organized on  
the job! **15<sup>99</sup>**  
45-4864-5

Regular 19.99 Value!  
With tote tray! Holds tools to 20"



DOUBLE FACE  
VINYL  
TAPE

**1<sup>55</sup>**  
1 1/2" x 42'



6 1/2" SLIP-JOINT  
PLIERS  
Knurled  
grips

Reg.  
1.69  
Value  
**1<sup>39</sup>**

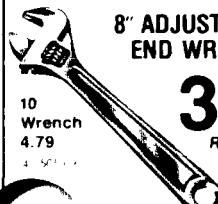

8" ADJUSTABLE  
END WRENCH

**3<sup>99</sup>**  
Regular 5.79

10  
Wrench  
4.79



18-PIECE  
SOCKET SET

**33<sup>99</sup>**  
45-744-1



Save  
2.50  
100-FT.  
STEEL TAPE

Reg.  
10.49  
at W.A. **7<sup>99</sup>**  
45-6514-1

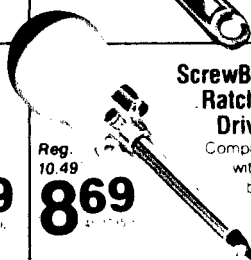

ScrewBall  
Ratchet  
Driver  
Complete  
with 4  
bits

Reg.  
10.49  
**8<sup>69</sup>**  
45-744-1



Save 2.50

100-WATT  
SOLDERING GUN

Spotlight,  
6-second heat  
Regular 15.99 **13<sup>49</sup>**  
45-4330-2

1-Lb Spool Acid or Rosin Core Sol-  
der, 1/8" d. 45-4380.81 ..... Each 4.69

**Save 4.00 Per Gallon!**

**OUR BEST HOUSE PAINT**

*Regular 14.99 per gallon.*

Sale priced now so that you can give your home a bright new spring look! Our finest house paint goes on easily, provides great coverage and has a beautiful sheen. One coat covers most surfaces—wood, brick or metal! Save now and rest assured you've invested in pure quality! Convenient "color ready" paint is available in white and 7 popular colors!

**Choice of 1350 Custom Colors. 69-1210.05.06.17 . . . Only \$1 More!**

**10<sup>99</sup>**  
Gallon  
69-1210.18.19.24-39

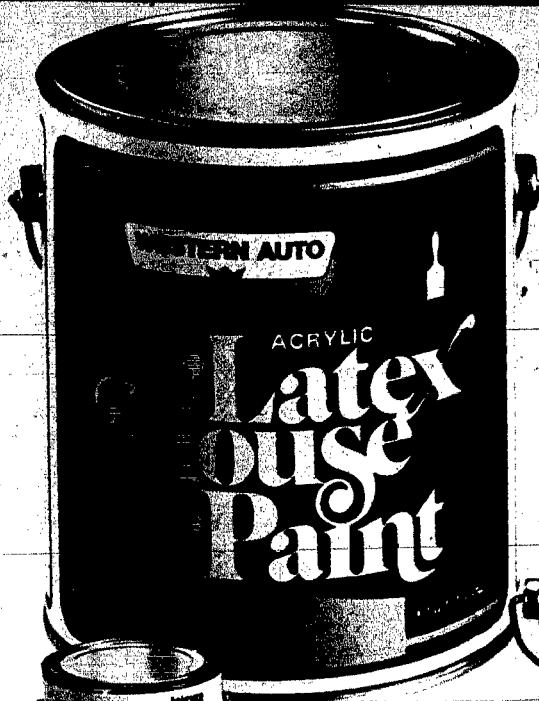

**Use Your Credit!**



**LATEX STAIN**

Goes on smooth. In amber, light brown or olive

**9<sup>99</sup>**  
69-3796-98  
One Gallon



**POLYURETHANE VARNISH**

Satin or high gloss  
1 quart.

**3<sup>99</sup>**  
69-3872-82

**Save 2.50**

**EXTERIOR LATEX HOUSE PAINT**

*Regular 10.99 Gallon!*

Flows on smoothly—any exterior. Resists peeling. Choose white or 4 colors

**8<sup>49</sup>**  
Gallon  
69-1250  
54-57

Custom Colors 69-1250.51 Only \$1 More!

**Save 3.50**

**INTERIOR LATEX WALL PAINT**

*Reg. 11.99* — Choose white or 7 ready-mix colors. Washable and durable finish. Easy cleanups. Whipped cream thick, less drip

**8<sup>49</sup>**  
Gallon  
69-2290-36

Custom Colors 69-2195.96.98.2200 \$1 More!

**Save 2.00**

**DELUXE INTERIOR WALL PAINT**

*Reg. 8.99* — For walls, ceilings, trim. Dries fast to flat, scrubbable finish. Choose white or 5 ready-mix colors.

**6<sup>99</sup>**  
Gallon  
69-1980 84-88

Custom Colors 69-1980-81 Only \$1 More!

**ZIPER SPECIAL**

**HI-GLOSS SPRAY ENAMEL**

**99<sup>c</sup>**

*Regular 1.59 Value!*  
12 ounce spray can alkyd base. All surface quick drying and rust inhibiting. Choose colors, metal finishes or primers. 22 colors available

WESTERN AUTO 42 PRICES AND TERMS OPTIONAL WITH DEALER



# Save on Home Fix Ups!

NYLON TOUCH-UP BRUSHES. LOW AS

**22¢**

1 in. 72 5442 8 27c  
1 1/2 in. 72 5443 6 32c  
2 in. 72 5444 4 42c

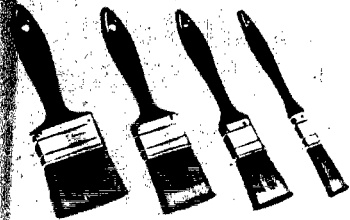

Save 3.00 Now! **10.99**  
ENTRANCE LOCKSET



Key lock outside, thumb turn inside  
Brass Entrance Lockset 47-1501-7 Pr. 20.99  
Antique Brass Lockset 47-1505-8 Ea. 12.99



Save 1.70!  
**DEADLATCH SET**  
Reg. 8.49 **6.79**



## STICK TO STAY GLUES & TAPE FROM W.A.

**KRAZY GLUE** - Bonds metal, rubber, plastic, ceramic 72 5006 1 98c  
**DURO E-Pox-E CEMENT** 72 5406 1 89c  
**E-Pox-E 5 Cement** 72 5401 4 1.29  
**Dow Corning SILICONE SEALER** Clear white liquid tube 72 5395 3 1.99

**DEVCON** 5 Minute EPOXY 1 quart dispenser 72 5421 4 1.29  
**Woodworker's GLOE** 8 1/2 oz. 5406 3 1.29  
**MASK TAPE** 1 1/2 in. x 36 ft. 72 5646 2 59c  
**Mask Tape** 1/2 in. x 36 ft. 72 5709 4 1.39  
**Strap Tape** 1 1/2 in. x 36 ft. 72 5649 4 1.69

**SHELF BRACKET** **29¢**  
5x8 in. 47-9820-3  
8x10 in. 47-9821-2 39c  
10x12 in. 47-9822-4 65c

Save 2.05 Now!  
**CHEMICAL/ELECTRICAL FIRE EXTINGUISHER**

Reg. 9.49

**7.44**

UL rated 5-B-C for gas oil paint electrical fires 13 1/2 lb fill



2 1/2" Barrel Bolt 47-9811-2 69c  
3" Barrel Bolt 47-9811-3 79c  
4" Barrel Bolt 47-9811-4 99c

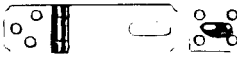

**AIR CONDITIONER WEATHERSTRIP**

**75¢**

2 1/2" Hinge Hasp 47-9814-2 75c  
3 1/2" Hinge Hasp 47-9814-3 99c  
4 1/2" Hinge Hasp 47-9814-4 1.19

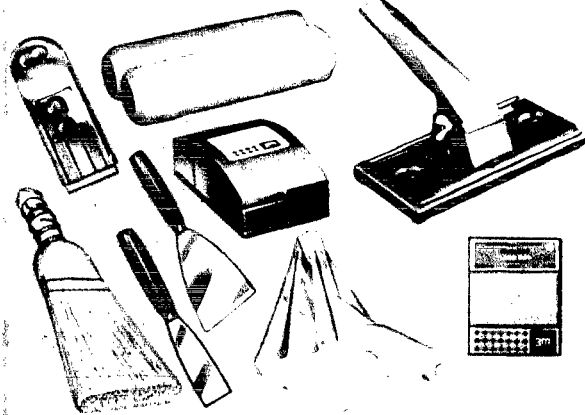

**RAZOR-TYPE PAINT SCRAPER** **99¢**  
Hyde Blades 72 5354 6 Pkg 10/79c  
**10 IN. CORN-TYPE WHISK BROOM** **99¢**  
**3 IN. FLEXIBLE PAINT SCRAPER** **69¢**  
**1 1/2 IN. FLEXIBLE PUTTY KNIFE** **57¢**  
**3M CUSTOM 6 PC PRESS 'N' SAND KIT** **2.49**  
Includes 5 sheets of sandpaper  
Refill Paper 72 5136 4 Pkg 10 1.19

**PAIR 9 INCH ROLLER COVERS** **89¢**  
**7 IN. PAD PAINT APPLICATOR** **2.99**  
7 in. Replacement Pad 72 5531 8 1.99  
**9x12 FT. PLASTIC DROP CLOTH** **59¢**  
Heavy-Duty Drop Cloth 72 5764 5 1.79  
**3M PRODUCTION SANDPAPER** **99¢**

Package of 6 sheets, extra fine Sand Block 72 5101 4 3.99

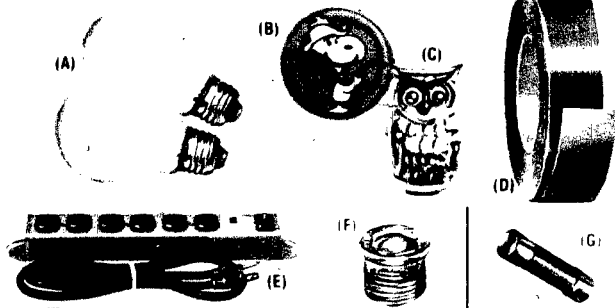

## SAVE ON DO-IT-YOURSELF ELECTRICAL NEEDS AT W.A.

(A) Bulbs 40 60 100W 53 9035 3" 4 1.00  
(B) Snoopy Night Light 53 3506 2 1.39  
(C) Owl Night Light 53 3501 2 1.39  
(D) Plastic Tape 1/2 x 30 ft. 53-3802 5 25c  
(E) Multiple Outlet Strip 53 3280 4 14.99  
(F) Plug Fuses 15 amp 53 3530 3" ea 15c  
(G) Fuses 35 40 50 60 53 3555-58 ea 47c  
(H) 50' 16/3 Ext. Cord 53 3899 1 6.49  
(J) 100' 16/3 Ext. Cord 53-3924 11.99  
(K) 15' Single Outlet Cord 53-3155 4 1.59

**W.A. is Your One-Stop Hardware Shop!**

# WESTERN AUTO CAN HELP YOU SAVE TIME &

As Seen on  
**TV**

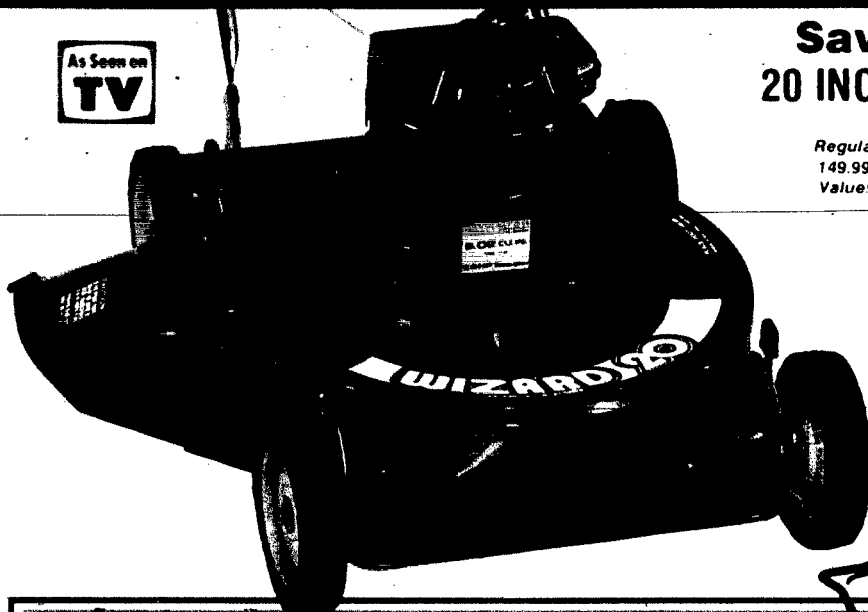

**Save 20.00 Now!**  
**20 INCH ROTARY MOWER**

Regular  
149.99  
Value!

**129<sup>99</sup>**

- Reliable 3½ H.P. Briggs & Stratton Engine!
- 5-Position Fingertip height adjustment (1½-3½ in.)
- Throttle Control conveniently mounted on "T" style handle
- Fully baffled side-discharge steel cutting deck with Ultra-lift steel blades

22 In Rotary Mower 93-6212-0 139.99

**Use Your Credit!**



**DIAL**

Western Auto has the best Catalog Ordering System in town! At most stores you'll know in minutes if the item is in stock and when you'll get it.

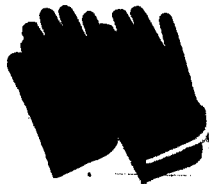

**GARDEN GLOVES**

Ladies' or Men's Styles **99<sup>c</sup>**

66-5007 28

Work Gloves 56-4027 1 49

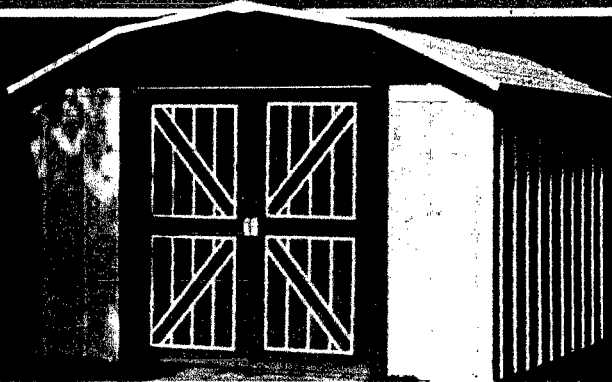

**10x7 FT. LAWN BUILDING**

Regular 209.99 Value! Inside storage area of 87.6 sq. ft. Lockable sliding door-54x64 Steel

**179<sup>99</sup>**

10x10 Ft. Storage Building, Inside slightly smaller 95-1847-3 219.99  
14x10 Ft. Storage Building, Inside slightly smaller 95-1848-1 299.99  
Wall Mount Shelves, 42 in. W Put in or outside bldg 95-1870-5 13.99

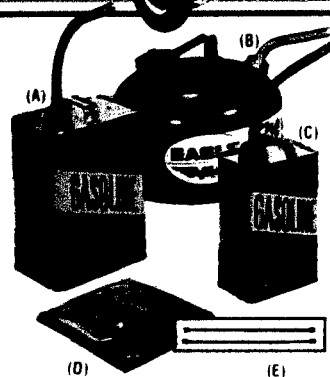

- (A) 2 Gal. Gas Can w spout 95-1404-3 2.69  
(B) Heavy Duty 2½ Gal. Gas Can with strainer pushbutton spout 95-1420-9 6.49  
(C) 1 Gal. Gas Can w spout 95-1401-9 1.99  
(D) 9x12 Ft. Poly. Tarp 95-5728-1 2.99  
(E) 14 Rubber Tie Strap 95-5752-1 2/1.49  
19 Rubber Tie down Strap 95-5754-1 2.1.49

# MONEY WITH ALL YOUR LAWN MOWING NEEDS!



USE YOUR CREDIT!

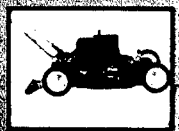

Save 10.00

Save 10.00

## DEPENDABLE 20 IN. 3 1/2 H.P. ROTARY MOWER

## 4 H.P. CONVERTIBLE MULCHING MOWER

Regular 119.99 Value! Features a rugged Briggs & Stratton engine. Throttle control conveniently mounted on T-style handle. 5-position height adjustment (1/2-3 1/2 in.). Easy rolling 7" wheels.

**109<sup>99</sup>**

Regular 179.99 Value! Converts from a regular side-discharge mower to a mulching power that cuts and recuts clippings into a fine organic mulch! Powerful Briggs & Stratton engine with vertical-pull starter. 5-position fingertip height adjustment (1 1/2-3 1/2 in.)

**169<sup>99</sup>**

22 in. 2 1/2 H.P. Mower 93-6202-3 \$119.99 20 in. 3 H.P. Mower 93-6000-9 \$99.99



10 H.P. RIDING POWER with Electric Start. Transaxle Drive

**899<sup>99</sup>**

Regular 959.99  
36 in. twin blade cutting deck. Electric start with alternator. 5-position height adj. (1 1/2-3 1/2 in.)

## SAVE 80.00! 8 H.P. RIDER

**599<sup>99</sup>**

Regular 679.99 Value! Briggs & Stratton engine. 30 in. twin blade cutting deck. 3 speeds. Automatic type. 2 front and 1 rear brakes. Adjustable padded seat.

Electric Start 8 H.P. Riding Mower 93-1265-4 \$689.99  
Grass Catcher 12 in. x 16 in. x 1 1/2 in. 93-1211-1 \$36.99

Convenient Credit Available

Use with all W.A. most other rotary-type mowers!

**GRASS CATCHER 17<sup>99</sup>**  
Replacement Bag 95-1110-6 \$9.99

## SAVE ON LAWN MOWER ACCESSORIES

- Small Engine Tune-Up Kit 95-1214 \$3.19
- Flywheel Keys Card of five 95-1215 \$1.99
- Woodruff Keys Pkg. of five 95-1216 \$1.99
- Lug Wheel for Power Propelled Mower 95-1217 \$2.79
- Wheel for Most Lawn Mowers 95-1218 \$2.39
- Axle Shoulder Bolts, 2 bolts cuts 95-1243-4 \$2.19
- Spark Plug, Brass electrode height 95-1211 \$1.89
- Flywheel Puller, Briggs & Stratton engines 95-1278 \$1.19
- 2 1/2 to 5 H.P. Mower Muffler 95-1245-4 \$1.19
- 8 H.P. Power Mower Muffler 95-1247-6 \$1.99
- Briggs & Stratton 5 H.P. Mower Muffler 95-1240-1 \$1.99
- Replacement Blade for Mower and Rider 95-1224-32 ea. \$2.99
- Blade Sharpener for lawn mowers 95-1265-8 \$1.59
- Universal Starter Handle, 42 in. rope 95-1243-5 \$1.49
- Gumout Mower Carburetor Cleaner 12 oz. 78-6954-P \$1.37
- Western Auto Starter Fluid 12 oz. 78-6955-5 \$1.19

# 25% OFF



## Save 2.39 60 FT. VINYL HOSE

Regular 9.49 Value! Replace your old hose now and save! Nylon-reinforced vinyl is strong and long-lasting. 300 pounds burst strength! Brass couplings.

**710**  
92-8444-9

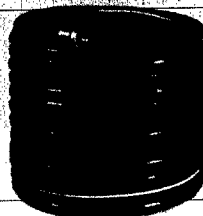

## 50' VINYL HOSE

Regular 3.99  
Budget priced!  
250 pounds of  
burst strength.

**299**  
92-8424-1

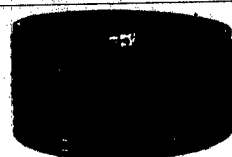

## REINFORCED HOSE

Regular 10.99  
50 feet long.  
Durable rein-  
forced vinyl.  
Solid brass couplings. 3/4" dia.

**824**  
92-8461-1



## Save 40c TRIGGER NOZZLE

Reg. 1.79  
**139**  
92-8128-8

Brass Twist Nozzle. 92-8138-7 3.99

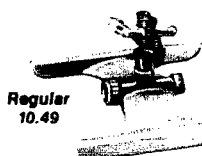

Regular 10.49

Save 2.62

## PULSATING SPRINKLER

Plastic and metal.  
With spray control  
Covers 8' dia. circle

**787**  
92-8225-2



## OSCILLATING LAWN SPRINKLER

Regular 14.69!  
4 watering po-  
sitions Brass  
jet nozzles Covers up to 3500  
square feet! Measures 27x6 1/2 x 7

**1099**  
92-8206-2

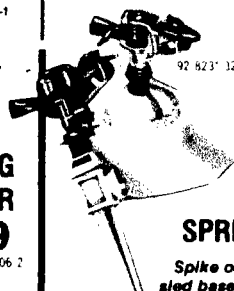

92-8231-12

Regular 4.59  
Value

## YOUR CHOICE! SPRINKLERS

Spike or  
sled base. **349**

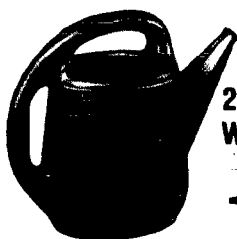

## 2 GAL. WATER CAN **159**

92-8186-6

Lightweight but durable plastic.



Save 1.50

## LAWN SOAKER **499**

Regular 6.49 Value!  
50 ft. soaking hose

**499**  
92-8474-6

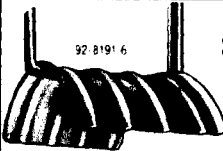

92-8191-6

SAVE 20c

## HOSE WALL-MOUNT

Regular 1.19 Value.  
Holds up to 150 feet  
of hose Sturdy!

**99c**

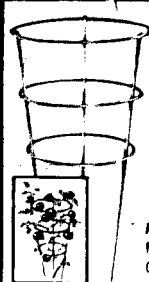

## Save 40c TOMATO RING

**119**  
92-1319-0

Reg. 1.59 Value.  
Measures 30 in. H  
Galvanized metal



## Save 30c ORNA- MENTAL LAWN FLOWER

34 in. Assorted colors.

Reg. 1.19  
Value **89c**  
92-7710-4

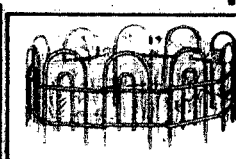

## WIRE FENCE

Reg. 2.69  
10 ft. x 18".  
White. Pro-  
tect your flower garden.

**199**  
92-1308-1

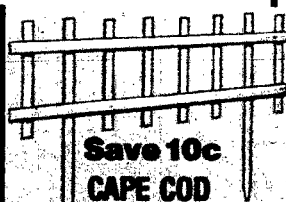

## Save 10c CAPE COD FENCE

Reg. 69c Value.  
33x11 in. high.  
Attractive white.

**59c**  
92-1308-7



## 8 INCH GARDEN HOE

Save 1.20

Reg. 5.69 Value.  
Curved blade for  
greater leverage.  
4 1/2 ft. handle. Lasts for years!

**449**  
92-3133-3

**Save! 1.00**  
**TRIMMER/  
EDGER**

**2399**  
95-2070-1

- Regular 24.99 Value!
- Convenient "Tap & Trim" Automatic Line Feed
- Full cutting line guard, double insulation
- Efficient 2.5 amp motor and dual cutting lines
- 50' Ext. Cord 53-3917-1 8.79
- 100' Ext. Cord 53-3918-9 15.49

Trimmer/Edger 3.5A  
95-2075-0 39.99  
Dix. Trimmer/Edger  
95-2080-0 44.99

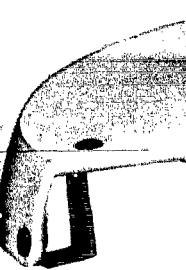
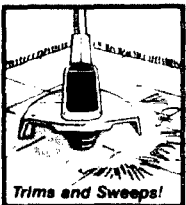
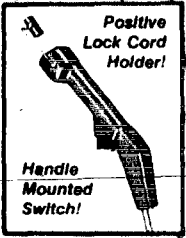

Get Yours on Credit Today!

**GRASS SHEAR**  
**329**

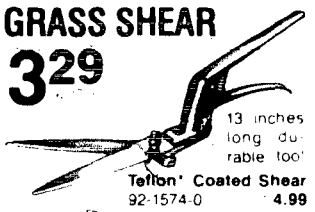

**GRASS WHIP**  
Reg. 4.49 **336**

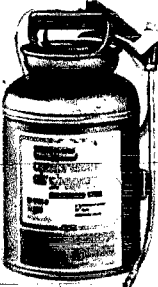

**THE CLIPPIE™**

**1499**  
95-2050-3

- Cuts up to an 8 in. path! Handles big jobs with ease. 12 ft. line or replacement spool.
- The Snippy™ 10" path 95-2042-0 24.99
- The Needle™ 16" path 95-2022-2 54.99

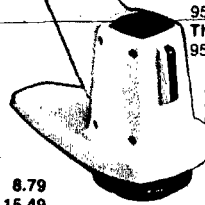

Repl Spool  
95-2123-8  
Now 1.39

**CORDLESS TRIMMER**  
**4799**

Cuts a 7 in. swath! Recharges in 48 hours! Handles jobs that trimmers with cords can't reach! No need to buy several extra extension cords!



**GRASS SHEAR**

**2199**

5,000 cuts per min. Runs 45-50 min. per charge.

Replacement Blade 92-2100-3 3.99

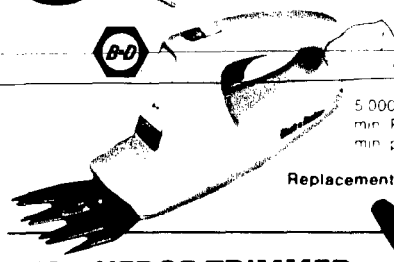

**16" HEDGE TRIMMER**

Double edged tempered steel blades with stay-sharp teeth Trim in any direction!

2.4 amps. 3600 spm **3499**

22 in. Heavy-Duty Trimmer 92-2016-1 54.99

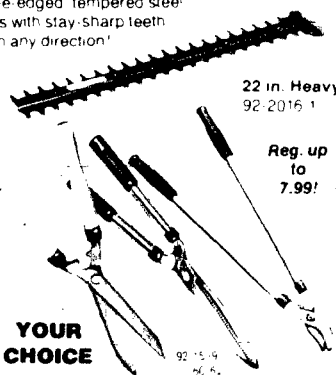

**YOUR CHOICE**

Hardwood or steel handle hedge shears or lopping shear with 20 in handle  
**649**  
Deluxe Lopping Shear 92-1540-1 13.99

**YOUR CHOICE GARDEN TOOLS**

Regular 1.99 each! **149**

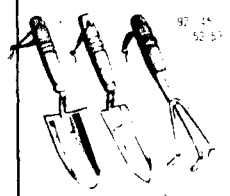

# 25% OFF

**EVERY ITEM ON THIS PAGE**

Supplement to  
Wayne Herald

34-931

As Seen on  
**TV**

Heavy duty  
32 MM—with  
58% MORE ride  
control capacity  
than standard 1-inch  
shock absorbers

Engineered to deliver  
impressive handling in  
tough driving conditions!

YOU MAY NEVER HAVE  
TO REPLACE THESE!

**Regular 14.99 Each!**

**OUR BEST SHOCK**  
0803 - B-8  
**899**  
EACH  
81-4700-60

For most late  
model cars &  
light trucks

It's the  
**TOUGH  
ONE!**



**TOUGH 2-CELL  
POLYETHYLENE  
FLASHLIGHT**

**139**  
28-4231-5  
less battery

Reg.  
1.99  
Value

**SUPER SPECIALS**

As Seen on  
**TV**

**YOUR CHOICE!  
DUAL STAGE AIR  
OR OIL FILTER**

**199**  
Reg. 3.99

Fit most cars.  
\*4-6006-18 74-5801-12

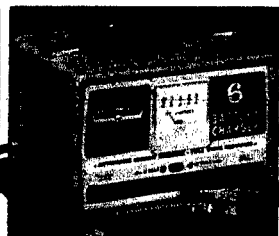

**SAVINGS ON SOLID STATE  
6-AMP BATTERY CHARGER**

**25% Off!**  
Regular 26.99  
6 & 12-volt  
**1888**  
#4-5093-6  
Automatic 10 Amp. #4-5096-7 29.88



Recharge Your Car's  
Air Conditioner  
14-OZ. FREON

**25% Off**  
**95¢**  
Regular 1.29  
#5-1401-7  
Recharge Kit 78-4402-0 3.99



Heavy Duty for All  
Cars and Trucks!  
**BRAKE FLUID**

**25% Off**  
**119**  
12-Oz. #1-4541-2  
Reg. 1.59  
Quant. 78-5542-2 2.49



**We'll be  
good  
to you!**

Like to own your own  
store? The dealer who  
sent you this circular will  
give you all of the details.

**SUPER SPECIALS**

**25% Off**  
**5-GAL. STEEL  
GAS CAN**

**599**  
95-1414-2  
Regular 7.99

**ALL LOCKING GAS CAPS  
25% Off!**

**Now Low as 319**  
With 2 keys.  
75-9404-07 09 11 13  
14-16-18-20

**Associate Store Home Owned**

**RON and JAN BROWN**

**115 West 1st Street—Phone: 375-1342**

**WAYNE, NEBRASKA 68787**

**CONVENIENT CREDIT AVAILABLE**

34-931